

HEYTEC
TOOLS





HEYTEC TOOLS AUS DEM HAUSE HEYCO

In der über 80-jährigen Unternehmensgeschichte haben wir uns zu einem der führenden Werkzeughersteller entwickelt. Angetrieben von der Leidenschaft, unseren Kunden Produkte anzubieten, die gekennzeichnet sind durch ein Höchstmaß an Qualität und Gebrauchsnutzen. Mit unserer Marke HEYTEC TOOLS sprechen wir den qualitäts- und preisbewussten Handwerker ebenso an wie den anspruchsvollen Heimwerker. Mit einem umfassenden, maßgeschneiderten Werkzeugprogramm, ausgerichtet auf die jeweiligen Bedürfnisse des Anwenders.

HEYTEC TOOLS MANUFACTURED BY HEYCO

In our company's more than 80-year history, we have developed to become one of the leading tool manufacturers. Driven by the passion for offering our customers products that are distinguished by exceptional quality and usability.

Our HEYTEC TOOLS brand addresses both quality and price conscious professional craftsmen and discerning DIY enthusiasts with a comprehensive portfolio of tailor-made tools aligned to the specific needs of their users.

INHALT CONTENTS

☰ 6-14



1

SCHRAUBENSCHLÜSSEL
RANGE OF WRENCHES
SCHROEFSLEUTELS
CLÉS
LLAVE

☰ 15-53



2

STECKSCHLÜSSEL
DOPSLEUTEL
SOCKET
CLÉS À DOUILLES
LLAVES DE VASO

☰ 54-66

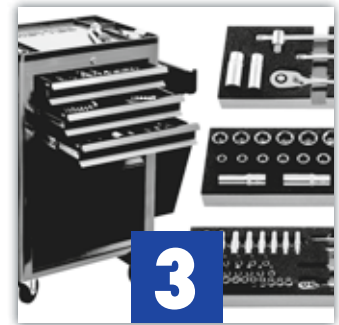

3

WERKSTATTWAGEN UND MODULE
WORKSHOP TROLLEYS AND MODULES
GEREEDSCHAPSWAGENS EN MODULES
CHARIOTS D'ATELIER ET MODULES
CARROS DE TALLER Y MÓDULOS

☰ 96-100



7

HÄMMER, MEISSEL, KÖRNER
HAMMERS, CHISELS, PUNCHES
HAMERS, BEITELS, DOORSLAGEN
MARTEAUX, BURINS, POINTEAUX
MARTILLOS, CINCELES, PUNZONES

☰ 101-109



8

SCHRAUBENDREHER, STECKSCHLÜSSEL
SCREWDRIVER, NUT SPINNER
SCHROEVENDRAAIERS, -DOP
TOURNEVIS, CLÉ À DOUILLE
DESTORNILLADOR, LLAVE DE VASO

☰ 110-112



9

BIT-SÄTZE
BIT SETS
BITSETS
JEUX D'EMBOUTS
JUEGOS DE BROCAS

☰ 153-157



13

KFZ-WERKZEUGE
AUTOMOBILE TOOLS
GEREEDSCHAP VOOR MOTORVOERTUIGEN
OULLAGE AUTOMOBILE
HERRAMIENTAS PARA AUTOMÓVILES

☰ 158-165



14

BAU-WERKZEUGE
CONSTRUCTION TOOLS
BOUWGEREEDSCHAPPEN
OUTILS DE CONSTRUCTION
HERRAMIENTAS DE CONSTRUCCIÓN

☰ 166-169



15

ALLGEMEINER WERKSTATTBEDARF
PRODUCTS FOR WORKSHOP
WERKPLAATS BENODIGDHEDEN
FOURNITURES GÉNÉRALES D'ATELIER
SUMINISTROS PARA TALLERES

☰ 67–83

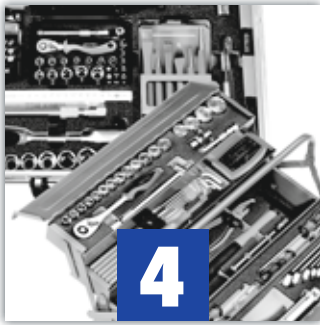

4

WERKZEUGSORTIMENTE
TOOL ASSORTMENTS
GEREEDSCHAPSETS
ASSORTIMENTS D'OUTILS
SURTIDOS DE HERRAMIENTAS

☰ 84–87



5

DREHMOMENTSCHLÜSSEL
TORQUE WRENCHES
DRAAIMOMENTSLEUTELS
CLÉS DYNAMOMÉTRIQUE
LLAVES DINAMOMÉTRICAS

☰ 88–95



6

ZANGEN UND SCHEREN
PLIERS AND KNIVES
TANGEN EN SCHAREN
PINCES ET CISEAUX
ALICATES Y TIJERAS

☰ 113–119



10

MESSER, FEILEN, SÄGEN
KNIVES, FILES, SAWS
MESSEN, VIJLEN, ZAGEN
COUTEAUX, LIMES, SCIES
CUCHILLOS, LIMAS, SIERRAS

☰ 120–139

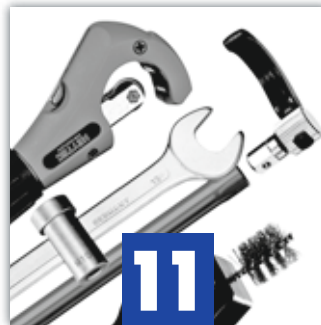

11

SANITÄRWERKZEUGE
SANITARY TOOLS
SANITAIRGEREEDSCHAPPEN
OUTILLAGE SANITAIRE
HERRAMIENTAS SANITARIAS

☰ 140–152



12

ELEKTRIKER-WERKZEUGE
ELECTRICIAN TOOLS
ELEKTRICIENS-GEREEDSCHAPPEN
OUTILS D'ÉLECTRICIEN
HERRAMIENTAS PARA ELECTRICISTAS

☰ 170–173



16

PRÄSENTATIONSSYSTEME
PRESENTATION SYSTEMS
PRESENTATIESYSTEMEN
SYSTÈMES DE PRÉSENTATION
SISTEMAS DE PRESENTACIÓN



1 KAPITEL CHAPTER

SCHRAUBENSCHLÜSSEL

Doppelmaulschlüssel
Ringmaulschlüssel
Einmaulschlüssel
Doppelringschlüssel
Knarrenringschlüssel

RANGE OF WRENCHES

Double Ended Open Jaw Wrenches
Combination Wrenches
Single Ended Open Jaw Wrenches
Double Ended Ring Wrenches
Combination Ratchet Wrenches

SCHROEFSLEUTELS

Steeksleutels
Ringsteeksleutels
Moersleutels
Ringsleutel
Ringratel-steeksleutels

CLÉS

clés à fourche double
clés mixtes
clés à molette
clés polygonales contrecoudées
clés mixtes à cliquet

LLAVES

Llaves fija doble
Llaves combinada
Llaves fija simple
Llaves de estrella doble
Llaves de estrella de carraca

50800

DIN 3110 / ISO 1085

Doppelmaulschlüssel

Chrom-Vanadium, verchromt

Double ended

open jaw wrenches

Chrome-Vanadium, chromium plated

Steeksleutel

Chroom-Vanadium, verchromd

Clés à fourche

Chrome-Vanadium, chromées

Llaves fijas de dos bocas

abiertas

Cromo Vanadio, cromadas

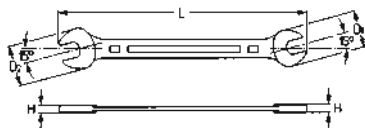

Bestell-No./Order-No.	ØMM	GL mm	H mm	D1 mm	D2 mm	g	
50800060780	6 x 7	122	3,6	15,7	17,7	18	10
50800080980	8 x 9	140	3,9	20,8	22,9	32	10
50800081080	8 x 10	140	3,9	20,8	22,9	32	10
50800101180	10 x 11	156	4,8	23,9	26,9	54	10
50800101380	10 x 13	172	5,3	28,0	31,0	67	10
50800111380	11 x 13	172	5,5	28,0	29,8	75	10
50800121380	12 x 13	172	5,3	28,0	31,0	61	10
50800131580	13 x 15	190	5,7	32,5	34,9	89	10
50800131780	13 x 17	204	5,9	32,1	38,2	110	10
50800141580	14 x 15	190	5,7	32,5	34,9	90	10
50800161780	16 x 17	204	5,9	36,1	39,2	105	10
50800161880	16 x 18	204	5,9	36,1	39,2	115	10
50800171980	17 x 19	223	6,5	40,2	42,3	155	10
50800181980	18 x 19	223	6,5	40,2	42,3	150	10
50800192280	19 x 22	236	6,8	44,9	48,4	190	10
50800202280	20 x 22	236	6,8	44,9	48,4	185	10
50800212380	21 x 23	250	7,3	47,4	51,5	265	5
50800242780	24 x 27	265	7,8	52,5	58,6	310	5
50800252880	25 x 28	280	8,1	55,2	61,3	350	5
50800273080	27 x 30	280	8,1	58,6	64,4	355	5
50800303280	30 x 32	302	8,6	64,8	70,3	480	5
50800323680	32 x 36	325	8,8	66,5	74,5	550	5
50800364180	36 x 41	358	8,8	74,5	84,0	730	5
50800414680	41 x 46	450	10,4	84,0	92,6	1140	5

K 50800 HP 50800 B 50800 R 50800

Doppelmaulschlüssel-Sätze

Double ended open jaw wrenches sets

Steeksleutelset

Jeux de clés à fourche

Juegos de llaves fijas de dos bocas abiertas

R 50890



B 50800



HP 50800



K 50800

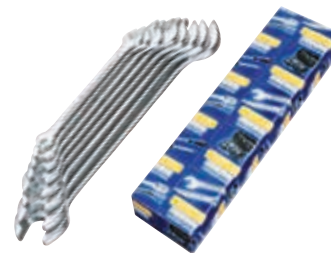

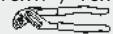
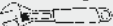
Bestell-No./Order-No.	Art. No.	ØMM	g	
50800021200	R 50800-212	Werkzeugrolltasche, leer / 12 Fächer/ Tool wallet, empty / 12 compartments	200	5
50800944080	K 50800-8-M	6x7 / 8x9 / 10x11 / 12x13 / 14x15 16x17 / 18x19 / 20x22	695	1
50800947080	K 50800-12-M	6x7 / 8x9 / 10x11 / 12x13 / 14x15 16x17 / 18x19 / 20x22 / 21x23 24x27 / 25x28 / 30x32	2100	1
50800844080	B 50800-8-M	6x7 / 8x9 / 10x11 / 12x13 / 14x15 16x17 / 18x19 / 20x22	710	1
50800644080	HP 50800-8-M	6x7 / 8x9 / 10x11 / 12x13 / 14x15 16x17 / 18x19 / 20x22	790	1
50800747080	R 50800-12-M	6x7 / 8x9 / 10x11 / 12x13 / 14x15 16x17 / 18x19 / 20x22 / 21x23 24x27 / 25x28 / 30x32	2101	1
50890300200	R 50890-12-M	6x7 / 8x9 / 10x11 / 12x13 / 14x15 16x17 / 18x19 / 20x22 / 21x23 / 24x27  240 mm  255 mm / 10"	1990	1

50810
DIN 3113 A / ISO 7738



Ringmaulschlüssel

Chrom-Vanadium, verchromt,
Schon-Profil

Combination wrenches

Chrome-Vanadium, chromium plated,
profile saver

Ringsteeksleutels

Chroom-Vanadium, verchromd,
profiel beschermer

Clés mixtes

Chrome-Vanadium, chromées,
profil de protection SP

Llaves combinadas

Cromo Vanadio, cromadas,
perfil especial SP

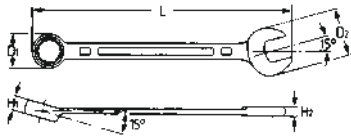

Bestell-No./Order-No.	ØMM	CL mm	H1 mm	H2 mm	D1 mm	D2 mm	⚖️	📦
50810006080	6	100	5,0	3,9	9,8	15,7	12	10
50810007080	7	110	5,5	4,2	11,2	17,0	18	10
50810008080	8	120	5,9	4,4	12,7	19,0	23	10
50810009080	9	130	6,4	4,7	14,1	20,9	33	10
50810010080	10	140	6,9	5,0	15,5	22,8	40	10
50810011080	11	150	7,4	5,2	16,9	25,4	48	10
50810012080	12	160	7,9	5,5	18,3	26,7	58	10
50810013080	13	170	8,4	5,8	19,7	29,3	63	10
50810014080	14	180	8,9	6,1	21,1	31,2	88	10
50810015080	15	190	9,3	6,3	22,6	33,0	97	10
50810016080	16	200	9,8	6,6	24,0	34,5	105	10
50810017080	17	210	10,3	6,9	25,4	37,3	130	10
50810018080	18	220	10,8	7,1	26,8	38,4	145	10
50810019080	19	230	11,1	7,3	28,2	40,4	145	10
50810020080	20	240	11,4	7,5	29,6	42,3	165	10
50810021080	21	250	11,7	7,7	31,0	44,2	190	10
50810022080	22	260	12,0	7,9	32,3	46,6	225	10
50810024080	24	280	12,7	8,3	35,1	50,1	265	5
50810027080	27	310	13,6	8,9	39,2	55,9	330	5
50810030080	30	340	14,6	9,5	43,4	62,6	430	5
50810032080	32	360	15,2	9,9	46,2	66,9	515	5
50810036080	36	400	22,8	14,1	54,6	77,5	1090	5
50810041080	41	450	25,8	15,8	62,1	83,7	1450	3

B 50810
HP 50810
K 50810
R 50810
DIN 3113 A / ISO 7738

Ringmaulschlüssel-Sätze

Chrom-Vanadium, verchromt,
Schon-Profil

Combination wrenches sets

Chrome-Vanadium, chromium plated,
profile saver

Ringsteeksleutelset

Chroom-Vanadium, verchromd,
profiel beschermer

Jeux de clés mixtes

Chrome-Vanadium, chromées,
profil de protection SP

Juegos de llaves combinadas

Cromo Vanadio, cromadas,
perfil especial SP

R 50810

R 50810-21

B 50810



HP 50810-12

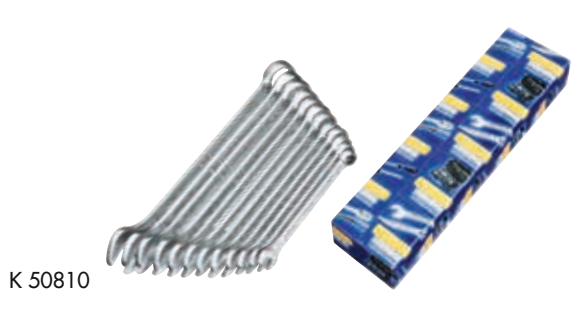

K 50810

Bestell-No./Order-No.	Art. No.	ØMM	⚖️	📦
50810924280	K 50810-8-M	8/9/10/11/13/14/17/19	570	1
50810927180	K 50810-12-M-1	8/9/10/11/12/13/14/15/16/17/18/19	1055	1
50810927280	K 50810-12-M-2	6/7/8/9/10/11/12/13/14/17/19/22	1135	1
50810929080	K 50810-17-M	6/7/8/9/10/11/12/13/14/15/16/17/18/19/20/21/22	1575	1
50810929480	K 50810-21-M	6/7/8/9/10/11/12/13/14/15/16/17/18/19/20/21/22/24/27/30/32	4080	1
50810824280	B 50810-8-M	8/9/10/11/13/14/17/19	590	1
50810827180	B 50810-12-M	8/9/10/11/12/13/14/15/16/17/18/19	980	1
50810724280	R 50810-8-M	8/10/12/13/14/15/17/19	675	1
50810727180	R 50810-12-M-1	8/9/10/11/12/13/14/15/16/17/18/19	1055	1
50810727280	R 50810-12-M-2	6/7/8/9/10/11/12/13/14/17/19/22	1055	1
50810729480	R 50810-21-M	6/7/8/9/10/11/12/13/14/15/16/17/18/19/20/21/22/24/27/30/32	3350	1
50810627380	HP 50810-12-M	8/10/11/12/13/14/15/16/17/18/19/22	1270	1

50839-9004

Mini-Einmaulschlüssel, verstellbar

Chrom-Vanadium, verchromt,
mit Kunststoff-Handschutz und Skala

Mini-Adjustable wrench

Chrome-Vanadium, chromium plated,
with soft grip plastic handle and scale

Mini Verstellbare moersleutel, omschakelbaar

Chroom-Vanadium, verchromd,
met kunststof handbescherming
en schaalverdeling

Mini clés à molette

Chrome-Vanadium, chromées,
avec poignée gainée et graduation

Mini llaves ajustables

Cromo Vanadio, cromadas,
con mango de plástico y escala



Bestell-No./Order-No.	Art. No.	mm	CLD "	MM/AF	g	
50839900480	50839-9004	110	4	0 - 15 0 - 5/8"	65	1

50839

Einmaulschlüssel, verstellbar

Chrom-Vanadium, verchromt,
mit Kunststoff-Handschutz und Skala

Adjustable wrenches

Chrome-Vanadium, chromium plated,
with soft grip plastic handle and scale

Verstellbare moersleutel

Chroom-Vanadium, verchromd,
met kunststof handbescherming en
schaalverdeling

Clés à molette

Chrome-Vanadium, chromées,
avec poignée gainée et graduation

Llaves ajustables

Cromo Vanadio, cromadas,
con mango de plástico y escala



Bestell-No./Order-No.	Art. No.	mm	CLD "	MM/AF	g	
50839000680	50839	160	6	0 - 20 0 - 1/4"	160	5
50839000880	50839	205	8	0 - 25 0 - 1"	310	5
50839001080	50839	255	10	0 - 30 0 - 1.1/4"	540	5
50839001280	50839	305	12	0 - 35 0 - 1.1/2"	800	5

- Geschmiedeter, gehärteter Schlüsselkörper aus hochwertigem Chrom-Vanadium-Stahl mit geschliffenem Schlüsselkopf, mit Nickel-Chromschicht galvanisiert gegen Korrosion, spezialgehärtete, gefräste Greifbacken
- Präzise Führung des gehärteten Schneckenrads
- Amerikanisches Modell mit 22° Maulstellung, rechtsgängig

- Chrome-Vanadium steel body, drop forged and hardened, polished head, nickel and chromium plated for protection against corrosion, specially hardened and milled jaws
- Precise running of hardened worm-wheel
- American pattern with 22° angled head and right hand movement



K 50839-3

Satz mit verstellbaren Einmaulschlüsseln

Adjustable wrenches set

Set met verstellbare
moersleutels

Jeu de clés à molette

Juegos de llaves ajustables



Bestell-No./Order-No.	Art. No.	MM/AF	g	
50839000100	K 50839-3	0 - 30 0 - 1.1/4"	1010	1

enthaltend je 1 St./containing each 1 pcs.: 50839-6 · 50839-8 · 50839-10

50805
DIN 838 / ISO 1085

Doppelringschlüssel,
tief gekröpft
Chrom-Vanadium, verchromt,
Schon-Profil

Double ended ring wrenches,
deep offset

Chrome-Vanadium, chromium plated,
profile saver

Ringsleutel, diep gebogen
Chroom-Vanadium, verchromd,
profiel beschermer

Clés polygonales contre-
coudées

Chrome-Vanadium, chromées,
profil de protection SP

Llaves de estrella acodadas,
de dos bocas

Cromo Vanadio, cromadas, acodado
profundo, perfil especial SP



Bestell-No./Order-No.	MM	mm	H1 mm	H2 mm	D1 mm	D2 mm	g	
50805060780	6 x 7	165	5,9	6,5	11,1	12,5	40	10
50805080980	8 x 9	180	6,9	7,4	14,3	15,5	58	10
50805101180	10 x 11	200	7,8	8,3	17,2	18,4	72	10
50805101380	10 x 13	220	7,4	8,7	15,4	19,8	100	10
50805121380	12 x 13	220	8,8	9,3	20,6	21,3	108	10
50805141580	14 x 15	245	9,7	10,2	23,3	24,2	140	10
50805161780	16 x 17	255	10,6	10,9	26,4	27,2	175	5
50805171980	17 x 19	285	12,0	12,0	26,8	28,5	285	5
50805181980	18 x 19	275	11,3	11,6	29,1	30,1	235	5
50805192280	19 x 22	285	11,8	12,3	30,2	31,3	275	5
50805202280	20 x 22	300	12,0	12,7	31,1	34,0	285	5
50805212380	21 x 23	315	12,4	13,1	33,0	36,0	305	5
50805242780	24 x 27	330	13,4	14,5	38,5	41,9	360	5
50805252880	25 x 28	350	13,8	14,9	40,4	43,9	450	5
50805303280	30 x 32	365	15,9	16,5	46,8	49,3	550	5

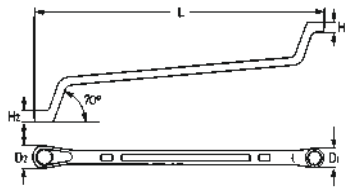

DAS HEYTEC-SCHONPROFIL

Schont Schrauben und Muttern. Setzt an den Flächen und nicht an den Kanten an. Eine positive Auswirkung ist die erheblich längere Lebensdauer.

THE HEYTEC-PROFILE SAVER

Protects screws and nuts whilst forces are applied on the flanks and not on edges, providing a much extended lifetime.

K 50805
R 50805
HP 50805
DIN 838 / ISO 1085

Doppelringschlüssel-Sätze,
tief gekröpft

Chrom-Vanadium, verchromt,
Schon-Profil

Double ended ring wrenches
sets, deep offset

Chrome-Vanadium, chromium plated,
profile saver

Ringsleutelsets, diep gebogen
Chroom-Vanadium, verchromd,
profiel beschermer

Jeux de clés polygonales
contre-coudées

Chrome-Vanadium, chromées,
profil de protection SP

Juegos de llaves de estrella
acodadas, de dos bocas
Cromo Vanadio, cromadas, acodado
profundo, perfil especial SP



R 50805



HP 50805



K 50805

Bestell-No./Order-No.	Art. No.	MM	g	
50805944080	K-50805-8-M	6x7 / 8x9 / 10x11 / 12x13 / 14x15 / 16x17 / 18x19 / 20x22	1120	1
50805947080	K-50805-12-M	6x7 / 8x9 / 10x11 / 12x13 / 14x15 / 16x17 / 18x19 / 20x22 / 21x23 / 24x27 / 25x28 / 30x32	2950	1
50805747080	R-50805-12-M	6x7 / 8x9 / 10x11 / 12x13 / 14x15 / 16x17 / 18x19 / 20x22 / 21x23 / 24x27 / 25x28 / 30x32	3100	1
50805644080	HP-50805-8-M	6x7 / 8x9 / 10x11 / 12x13 / 14x15 / 16x17 / 18x19 / 20x22	1320	1

50720

Knarren-Ringmaulschlüssel

Chrom-Vanadium, verchromt, 72 Zähne, Drehmoment Ring nach DIN 899 Reihe A / ISO 1711-1, Maul nach DIN 899 Reihe C / ISO 1711

Combination ratchet wrenches

Chrome-Vanadium, chromium plated, 72 teeth, torque on ring to DIN 899 row A / ISO 1711-1, on open end to DIN 899 row C / ISO 1711

Ringratel-steeksleutels

Chroom-Vanadium, verchromd, 72 tanden, draaimoment-ring volgens DIN 899 rij A / ISO 1711-1, bek volgens DIN 899 rij C / ISO 1711

Clés mixtes à cliquet

Chrome-Vanadium, chromées, 72 dents, couple côté polygonal suivant DIN 899 rang A / ISO 1711-1, fourche suivant DIN 899 rang C / ISO 1711

Llaves combinadas boca

estrella con carraca

Cromo Vanadio, cromadas, par de apriete: boca estrella según DIN 899 serie A / ISO 1711-1, boca abierta según DIN 899 serie C / ISO 1711



Bestell-No./Order-No.	ØMM	CL mm	H1 mm	H2 mm	D1 mm	D2 mm	g	mm
5072008080	8	140,0	6,6	4,6	17,0	16,8	32	10
5072009080	9	150,0	7,0	5,0	19,5	18,5	40	10
50720010080	10	160,0	7,5	5,3	20,5	20,8	59	10
50720011080	11	165,0	8,0	6,0	22,2	23,0	70	10
50720012080	12	172,0	8,3	6,3	23,0	25,3	77	10
50720013080	13	178,0	8,7	6,6	25,3	27,2	85	10
50720014080	14	190,0	9,0	6,8	28,2	29,2	105	10
50720015080	15	200,0	9,5	7,0	29,2	31,5	125	10
50720016080	16	207,0	10,0	7,5	30,0	32,8	225	10
50720017080	17	225,0	10,3	7,7	31,7	35,0	160	10
50720018080	18	240,0	11,5	8,3	32,2	37,5	200	10
50720019080	19	248,0	10,3	8,7	34,3	39,5	210	10
50720022080	22	278,0	10,3	9,0	42,0	45,0	381	10
50720024080	24	300,8	13,4	9,9	46,7	51,5	500	5
50720027080	27	304,1	14,9	10,9	48,7	55,9	601	5

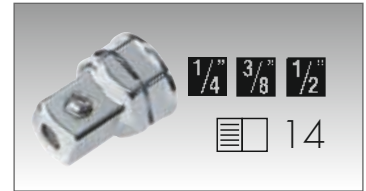
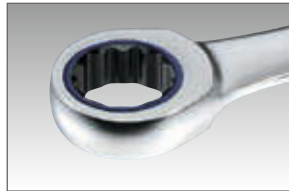
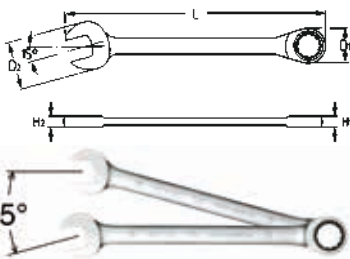

K 50720
R 50720
M 50720

Knarren-Ringmaulschlüssel-Sätze

Combination ratchet wrenches sets

Ringratel-steeksleutelset

Jeux de clés mixtes à cliquet

Juegos de llaves combinadas boca estrella con carraca



R 50720-6-M



R 50720-8-M



M 50720



K 50720

Bestell-No./Order-No.	Art. No.	ØMM	g	mm
50720600080	K 50720-6-M	8/10/12/13/17/19	623	1
50720600180	R 50720-6-M	8/10/12/13/17/19	755	1
50720600380	R 50720-8-M	8/10/12/13/14/15/17/19	1005	1
50720600280	M 50720-10-M	8/10/12/13/14/15/16/17/18/19	1400	1

50725

Knarren-Ringmaulschlüssel, umschaltbar

Chrom-Vanadium, verchromt, 72 Zähne, Drehmoment Ring nach DIN 899 Reihe A / ISO 1711-1, Maul nach DIN 899 Reihe C / ISO 1711

Combination ratchet wrenches, reversible

Chrome-Vanadium, chromium plated, 72 teeth, torque on ring to DIN 899 row A / ISO 1711-1, on open end to DIN 899 row C / ISO 1711

Omschakelbare ringratel-steeksleutel

Chroom-Vanadium, verchromd, 72 tanden, draaimoment-ring volgens DIN 899 rij A / ISO 1711-1, bek volgens DIN 899 rij C / ISO 1711

Clés mixtes à cliquet réversible

Chrome-Vanadium, chromées, 72 dents, couple côté polygonal suivant DIN 899 rang A / ISO 1711-1, fourche suivant DIN 899 rang C / ISO 1711

Llaves combinadas boca estrella con carraca reversible

Cromo Vanadio, cromadas, par de apriete: boca estrella según DIN 899 serie A / ISO 1711-1, boca abierta según DIN 899 serie C / ISO 1711



Bestell-No./Order-No.	MM	CL mm	H1 mm	H2 mm	D1 mm	D2 mm	g	
50725008080	8	140,0	8,2	5,3	17,0	17,0	37	10
50725009080	9	150,0	8,2	5,5	19,0	18,8	47	10
50725010080	10	160,0	8,4	6,0	20,5	21,7	62	10
50725011080	11	165,0	9,4	6,4	21,5	23,0	71	10
50725012080	12	170,0	9,4	6,5	22,5	25,2	84	10
50725013080	13	178,0	9,4	7,3	24,0	26,5	95	10
50725014080	14	190,0	9,4	7,5	26,5	29,6	112	10
50725015080	15	200,0	9,4	7,8	28,0	31,3	142	10
50725016080	16	210,0	11,1	8,1	29,0	33,4	155	10
50725017080	17	225,0	11,1	8,4	30,5	36,3	175	10
50725018080	18	237,0	12,4	9,1	31,5	38,0	210	10
50725019080	19	248,0	12,4	9,3	33,0	39,0	235	10
50725022080	22	290,0	13,0	9,3	39,0	46,0	380	10
50725024080	24	335,0	14,5	10,4	45,5	52,3	530	5
50725027080	27	353,0	14,8	11,6	51,8	58,5	624	5
50725030080	30	419,0	16,8	12,2	59,3	64,5	939	5
50725032080	32	420,0	16,9	12,2	59,5	64,6	942	5

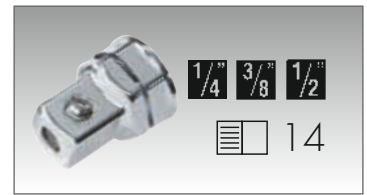
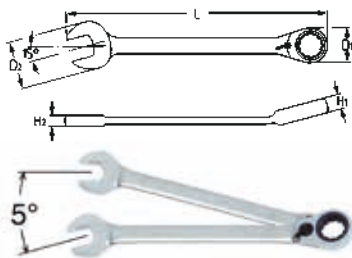

K 50725 R 50725 M 50725

Knarren-Ringmaulschlüssel-Sätze, umschaltbar

Combination ratchet wrenches sets, reversible

Omschakelbare ringratel-steeksleutelset

Jeux de clés mixtes à cliquet réversible

Juegos de llaves combinadas boca estrella con carraca reversible



R 50725-8



M 50725

K 50725

Bestell-No./Order-No.	Art. No.	MM	g	
50725600080	K 50725-6-M	8/10/12/13/17/19	690	1
50725600180	R 50725-6-M	8/10/12/13/17/19	825	1
50725600380	R 50725-8-M	8/10/12/13/14/15/17/19	974	1
50725600280	M 50725-10-M	8/10/11/12/13/14/16/17/18/19	1550	1

50725-6005

10-tlg./pcs./-dlg./pces./pzs.



Knarren-Ringmaulschlüssel-Satz

Multifunktion 3 in 1
Maulschlüssel, Ringschlüssel, Knarre.
Knarren-Ringmaulschlüssel aus Chrom-Vanadium Stahl, verchromt, mit Hebelumschaltung, 72 Zähne, Drehmoment Ring nach DIN 899 Reihe A / ISO 1711-1, Maul nach DIN 899 Reihe C / ISO 1711.

Combination ratchet wrenches set

Multifunction 3 in 1
Open jaw wrenches, ring wrenches, ratchet. Combination ratchet wrench, made of Chrome-Vanadium steel, chromium plated, 72 teeth, torque on ring to DIN 899 row A / ISO 1711-1, on open end to DIN 899 row C / ISO 1711.

Omschakelbare ringratel-steeksleutelset

Multifunctie 3-in-1
Steeksleutel, ringsleutel, ratel.
Ratelringsleutel uit Chrom-Vanadium staal, verchromd, met omschakelpal, 72 tanden, draaimomentring volgens DIN 899 rij A / ISO 1711-1, bek volgens DIN 899 rij C / ISO 1711.



Jeu de clés mixtes à cliquet

Multifonction 3 en 1
Clé plate, clé polygonale, cliquet. Clés mixtes à cliquet de Chrome-Vanadium, chromées, 72 dents, couple côté polygonal suivant DIN 899 rang A / ISO 1711-1, fourche suivant DIN 899 rang C / ISO 1711.

Juego de llaves combinadas con carraca

Multiusos 3 en 1
Llave de boca, llave de estrella, carraca. Llaves combinados de Cromo Vanadio, cromadas, par de apriete: boca estrella según DIN 899 serie A / ISO 1711-1, boca abierta según DIN 899 serie C / ISO 1711.



enthaltend/containing	
	MM 8/10/11/13/14/17/19
	1/4" / 3/8" / 1/2"

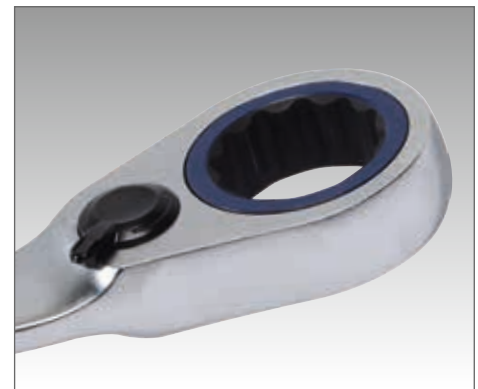

Bestell-No./Order-No.	Art. No.	Maße - Dimensions		
50725600580	50725-6005	250 x 140 x 40	1600	1

50730

4 in 1

Knarren-Ringschlüssel

Chrom-Vanadium, verchromt,
mit Hebelumschaltung, 72 Zähne

Ratchet wrenches

Chrome-Vanadium, chromium plated,
with reversible ratchet, 72 teeth

Ringratel-steeksleutel

Chrom-Vanadium, verchromd, met
omschakelpal, 72 tanden

Clé polygonale à cliquet

Chrome-Vanadium, chromées,
avec cliquet réversible, 72 dents

Llave boca estrella con carraca

Cromo Vanadio, cromada,
con carraca reversible, 72 dientes



Bestell-No./Order-No.	Art. No.	CLD mm	MM	g	
50730081383	50730	165	8 x 10 x 12 x 13	105	5
50730091583	50730	180	9 x 11 x 14 x 15	150	5
50730101983	50730	251	10 x 13 x 17 x 19	273	5
50730161983	50730	225	16 x 17 x 18 x 19	255	5
50730202483	50730	255	20 x 21 x 22 x 24	480	5



R 50730-3

4 in 1

3-tlg./pcs./-dlg./pces./pzs.

Knarren-Ringschlüssel-Satz

In stabiler Textil- Gürteltasche mit
Klettverschluss

Ratchet wrenches set

In solid textile belt bag with velcro sealing

Ringratel-steeksleutelset

In stevige nylon tas met klittebandsluiting

Jeu de clés polygonales à cliquet

En étui de ceinture résistant avec
fermeture velcro

Juegos de llaves boca estrella con carraca

En cinturón portaherramientas de tela,
con cierre de velcro



Bestell-No./Order-No.	Art. No.	MM	g	
50730600183	R 50730-3	8 x 10 x 12 x 13 9 x 11 x 14 x 15 16 x 17 x 18 x 19	495	1

50825-/50840-/50850-12

Adapter für

Knarren-Ringmaulschlüssel

Adapter for
combination ratchet wrenches

Adapter voor
ringratel-steeksleutel

Adaptateurs pour
clés à cliquet

Adaptador para llaves combina-
das boca estrella con carraca



Bestell-No./Order-No.	Art. No.	■	für · for HEYTEC No.	MM	g	
50825121083	50825-1210	1/4"	50720	10	6	10
50840121383	50840-1213	3/8"	+	13	18	10
50850121983	50850-1219	1/2"	50725	19	50	10



2 KAPITEL CHAPTER

STECKSCHLÜSSEL

Garnituren, Steckschlüsseleinsätze
Knarren
Verlängerungen, Adapter
Steckgriffe, Griffe mit Gleitstück
Impact Einsätze

SOCKET

Socket Sets, Sockets
Ratchets
Extensions, Adapter
Spinner handle, Sliding T-handles
Impact Sockets

DOPSLEUTEL

Sets, Dopsleutels
Ratels
Verlengstukken, Reductor
Greep met schuifstuk
Impact Dopsleutels

CLÉS À DOUILLES

Composition de douilles, Douilles pour vis
Cliquets
Rallonges, Réducteur
Rallonge emmanchée, Poignée coulissante
Douille Impact

LLAVES DE VASO

Juegos, llaves de vaso
Carracas
Prolongadores, adaptadores
Mangos enchufables
Mangos con pieza deslizante
Insertos de impacto



Chrom-Vanadium, verchromt
 Chrome-Vanadium, chromium plated
 Chrom-Vanadium, verchromd
 Chrome-Vanadium, chromées
 Cromo Vanadio, cromadas

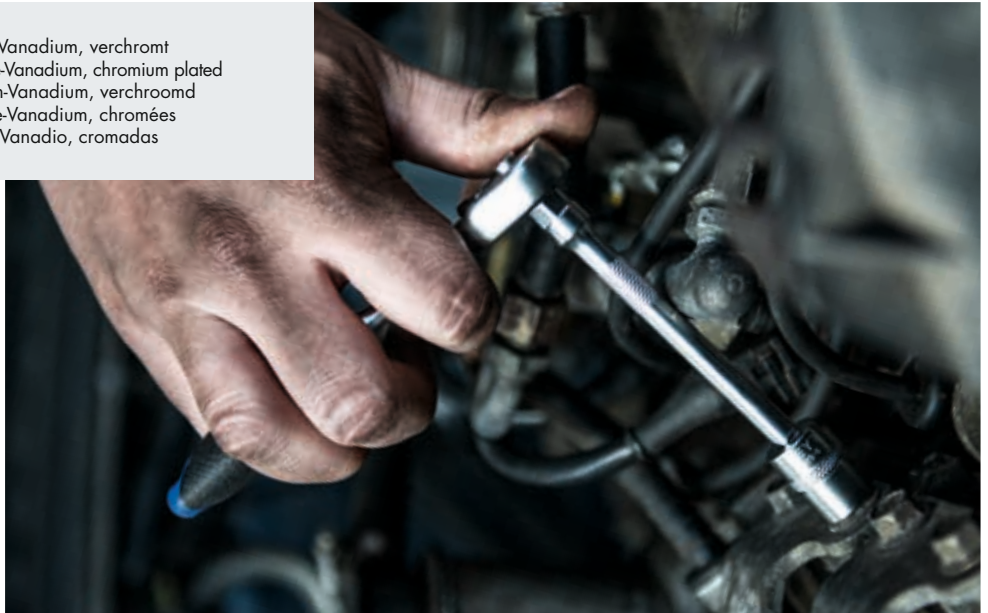

Hebelumschaltknarre

Mit Auswerferstift zum Schnelllösen der Steckverbindung.

Lever type reversible ratchet

With quick release ejector button.

Omschakelbare ratel

Met pal, met ontgrendelstift.

Cliquets réversibles

Tige d'éjection pour libérer rapidement l'outil du cliquet.

Carraca reversible

Con expulsor para separación instantánea de vasos y accesorios.

50825-00-15

DIN 3122 D · ISO 3315

48 Zähne/teeth/tanden/dents/dientes

Mit ergonomischem 2-K Griff.

With ergonomic 2 components handle.

Met ergonomische 2 componenten greep.

Avec poignée ergonomique bimatière.

Con mango ergonómico de dos componentes.



Bestell-No./Order-No.	Art. No.		mm		
50825015083	50825-00-15	1/4"	150	135	5

50825-00-17

48 Zähne/teeth/tanden/dents/dientes

Arretierbar mit ergonomischem

2-K Griff und Gürtelclip.

Lockable with ergonomic 2 components handle and belt clip.

Knikbaar, met ergonomische 2 componenten greep en riemclip.

Cliquet articulé avec poignée ergonomique bimatière et adaptateur de ceinture.

Bloqueable con mango ergonómico de dos componentes más clip para el cinturón.



Bestell-No./Order-No.	Art. No.		mm		
50825017083	50825-00-17	1/4"	140	146	5

50825-10-16

72 Zähne/teeth/tanden/dents/dientes

Gebogener Stahlkern.

Offset handle.

Gebogen stalen kern.

Poignée courbée en acier.

Mango acodado.



Bestell-No./Order-No.	Art. No.		mm		
50825101680	50825-10-16	1/4"	150	250	5

50825-10-17

60 Zähne/teeth/tanden/dents/dientes

Mit Auswerferstift zum Schnellösen der Steckverbindung. Mit ergonomischem 2-K Griff. 30% mehr Drehmoment durch innovative Sperrfunktion.

With quick release ejector button. With ergonomic 2 components handle. Innovative locking function for 30% higher torque.

Met ontgrendelstift. Met ergonomische 2 componenten greep. 30% meer draaimoment door innovatieve blokkeerfunctie.

Tige d'éjection pour libérer rapidement l'outil du cliquet. Avec poignée ergonomique bimatière. 30% plus de couple grâce à la fonction de blocage innovante.

Con expulsor para separación instantánea de vasos y accesorios. Con mango ergonómico de dos componentes. Par de apriete aumentado en un 30% gracias a la función de bloqueo innovador.



	NORMAL	HEYTEC	Gewicht/ weight %
1/4"	128 g	89 g	-30%
3/8"	315 g	217 g	-30%
1/2"	645 g	442 g	-30%

Extrem schlank, bestens geeignet für enge Bauräume.
Extremely slim, best suited for places of hard access.

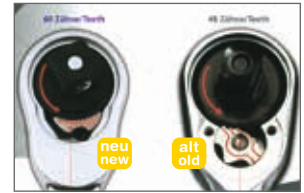
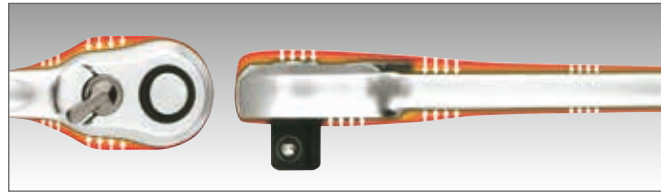
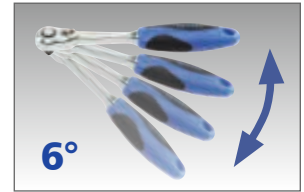

Bestell-No./Order-No.	Art. No.		CLØ mm		
50825101783	50825-10-17	1/4"	150	150	5

50825-11-15

48 Zähne/teeth/tanden/dents/dientes

Mit Auswerferstift zum Schnellösen der Steckverbindung. Mit ergonomischem 2-K Griff.

With quick release ejector button. With ergonomic 2 components handle.

Met ontgrendelstift. Met ergonomische 2 componenten greep.

Tige d'éjection pour libérer rapidement l'outil du cliquet. Avec poignée ergonomique bimatière.

Con expulsor para separación instantánea de vasos y accesorios. Con mango ergonómico de dos componentes.



Ideal für schwer zugängliche Stellen.
Ideal for hard of access workplaces.

Bestell-No./Order-No.	Art. No.		CLØ mm		
50825111583	50825-11-15	1/4"	115	94	5

50825-00-18

48 Zähne/teeth/tanden/dents/dientes

T-Griff mit Ratschenfunktion

Mit Auswerferstift zum Schnellösen der Steckverbindung. Arretierbar, aus Zink-Druckguß in schwerer Ausführung.

T-handle with ratchet

With quick release ejector button. Made of heavy duty die-cast zinc, with quick release mechanism.

T-greep met ratelfunctie

Met ontgrendelstift. Knikbaar, uit spuitgietzink, zware uitvoering.

T-poignée cliquet

Tige d'éjection pour libérer rapidement l'outil du cliquet. En zamac avec mécanisme de déconnexion rapide.

Mango en T con carraca

Con expulsor para separación instantánea de vasos y accesorios. Acabado en zinc colado a presión en ejecución fuerte con mecanismo de separación instantánea.



Mit Schnellösemechanik und rechts/links-Umschaltung.
Stop-function and right-left switch.



Bestell-No./Order-No.	Art. No.		CLØ mm		
50825018083	50825-00-18	1/4"	115	146	5



Chrom-Vanadium, verchromt
 Chrome-Vanadium, chromium plated
 Chrom-Vanadium, verchromd
 Chrome-Vanadium, chromées
 Cromo Vanadio, cromadas

50833-3-1

48 Zähne/teeth/tanden/dents/dientes

Mini-Bit-Knarre

Mit Auswerferstift zum Schnellösen der Steckverbindung. Blau eloxiert.

Mini-bit ratchet

With quick release ejector button. Blue anodized.

Mini ratelbithouder

Met ontgrendelstift. Blauw geëloxeerd.

Mini cliquet à embouts

Tige d'éjection pour libérer rapidement l'outil du cliquet. Bleu anodisé.

Carraca mini para

Con expulsor para separación instantánea de vasos y accesorios. Anodizado azul.



Rechts/links-Umschaltung, zur Aufnahme von Bits.
 Reversible (clockwise/counter-clockwise), for direct adaption of bits.

Bestell-No./Order-No.	Art. No.		CLD mm		
50833300100	50833-3-1	1/4"	85	46	5

50825-03

DIN 3123 B · ISO 3316

Griff mit Gleitstück

Sliding Thandle

Greep met schuifstuk

Poignée coulissante

Mango corredizo



Bestell-No./Order-No.	Art. No.		CLD mm		
50825030083	50825-03	1/4"	115	42	10

50825-04/05/05-5

DIN 3123 B · ISO 3316

Verlängerungen

Extension bars

Verlengstukken

Rallonges

Alargaderas



50825-04



50825-05



50825-05-5



50825-05-5

Bestell-No./Order-No.	Art. No.		CLD mm		
50825040083	50825-04	1/4"	50	35	10
50825050083	50825-05	1/4"	100	44	10
50825055083	50825-05-5	1/4"	102	43	5

50825-05-6/-7

Verlängerungen mit Zugbetätigung

Zum Schnellösen und zur Arretierung der Steckverbindung.

Extension bars

With quick release.

Verlengstukken

Met snelwissel mechanisme.

Rallonges

Avec déconnexion rapide automatique ou blocage du connecteur.

Alargaderas

Con telemando para separación instantánea e inmovilización del conector.



50825-05-6



50825-05-7

Bestell-No./Order-No.	Art. No.		CLD mm		
50825056083	50825-05-6	1/4"	100	49	10
50825057083	50825-05-7	1/4"	250	109	5

50825-08

DIN 3122 E · ISO 3315

Steckgriff

Spinner handle

Schroevendraaiergreep

Rallonge emmanchée

Mango recto



Bestell-No./Order-No.	Art. No.		CL mm		
50825080083	50825-08	1/4"	150	98	10

50825-06

DIN 3123 C · ISO 3316

Kardangelen

Universal joint

Kardangewricht

Cardan universel

Articulaciones universales



Bestell-No./Order-No.	Art. No.		CL mm		
50825060083	50825-06	1/4"	37	26	10

50825-6

DIN 3124 / ISO 2725

Steckschlüsseleinsätze, sechskant

Chrom-Vanadium, verchromt

Sockets, hexagon

Chrome-Vanadium, chromium plated

Dopsleutels, zeskant

Chroom-Vanadium, verchromd

Douilles, 6 pans

Chrome-Vanadium, chromées

Llaves de vaso, boca hexagonal

Cromo Vanadio, cromadas



Bestell-No./Order-No.		CL mm	T mm	D1 mm	D2 mm		
50825600483	4	25,0	9,0	7,0	12,0	9	10
50825604583	4,5	25,0	9,0	7,0	12,0	10	10
50825600583	5	25,0	9,0	8,0	12,0	10	10
50825605583	5,5	25,0	9,0	9,0	12,0	9	10
50825600683	6	25,0	9,0	9,0	12,0	10	10
50825600783	7	25,0	9,0	10,0	12,0	11	10
50825600883	8	25,0	9,0	12,0	12,0	12	10
50825600983	9	25,0	11,0	13,0	13,0	14	10
50825601083	10	25,0	11,0	14,0	14,0	15	10
50825601183	11	25,0	12,0	16,0	16,0	21	10
50825601283	12	25,0	13,0	17,0	17,0	24	10
50825601383	13	25,0	13,0	18,0	18,0	27	10
50825601483	14	25,0	14,0	19,5	19,5	34	10
50825601583	15	25,0	15,0	21,5	21,5	52	10

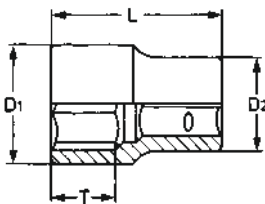

50825-19

DIN 3124 / ISO 2725

Steckschlüsseleinsätze, extra lang

Chrom-Vanadium, verchromt

Sockets, extra deep

Chrome-Vanadium, chromium plated

Dopsleutels, verlengd

Chroom-Vanadium, verchromd

Douilles, extra longues

Chrome-Vanadium, chromées

Llaves de vaso, extra-largas

Cromo Vanadio, cromadas



Bestell-No./Order-No.		CL mm	T mm	D1 mm	D2 mm		
50825190683	6	50,0	12,0	10,0	12,0	22	10
50825190783	7	50,0	19,0	10,5	12,0	23	10
50825190883	8	50,0	19,0	12,0	12,0	25	10
50825190983	9	50,0	19,0	13,0	12,0	29	10
50825191083	10	50,0	21,0	14,5	13,0	35	10
50825191183	11	50,0	23,0	16,0	14,0	42	10
50825191283	12	50,0	23,0	17,0	15,0	45	10
50825191383	13	50,0	23,0	18,0	16,0	52	10
50825191483	14	50,0	23,0	19,0	17,0	55	10

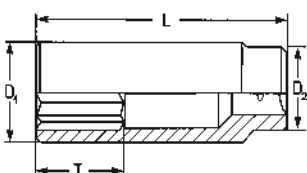



Chrom-Vanadium, verchromt
 Chrome-Vanadium, chromium plated
 Chrom-Vanadium, verchromd
 Chrome-Vanadium, chromées
 Cromo Vanadio, cromadas

50825-20



Steckschlüsseleinsätze für Außen-TORX®-Schrauben

Chrom-Vanadium, verchromt

Sockets for

TORX®-head screws

Chrome-Vanadium, chromium plated

Dopsleutels voor

TORX® bouten

Chrom-Vanadium, verchromd

Douilles pour vis

TORX® extérieures

Chrome-Vanadium, chromées

Llaves de vaso para tornillos

TORX® exteriores

Cromo Vanadio, cromadas

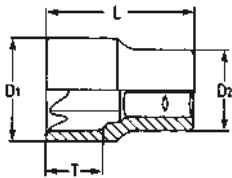

Bestell-No./Order-No.	E	mm	CL mm	T mm	D1 mm	D2 mm	g	
50825200483	4	3,86	25,0	7,0	7,0	12,0	10	10
50825200583	5	4,75	25,0	7,0	8,0	12,0	10	10
50825200683	6	5,74	25,0	7,0	9,0	12,0	11	10
50825200783	7	6,22	25,0	12,0	11,0	12,0	12	10
50825200883	8	7,52	25,0	12,0	12,0	12,0	13	10
50825201083	10	9,42	25,0	12,0	14,0	14,0	15	10
50825201183	11	10,08	25,0	12,0	16,0	16,0	19	10



50825-30



50825-31



50825-32



50825-33



50825-35



50825-37



50825-30 – 50825-37

Schraubendreher-Einsätze

Chrom-Vanadium, verchromt

Screwdriver sockets

Chrome-Vanadium, chromium plated

Schroevendraaier dopsleutels

Chrom-Vanadium, verchromd

Douilles tournevis

Chrome-Vanadium, chromées

Llaves de vaso con

destornillador

Cromo Vanadio, cromadas

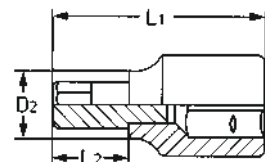

Bestell-No./Order-No.	Art. No.	L1 mm	L2 mm	D2 mm	g			
50825300383	50825-30	4,0	0,7	36,0	18,0	12,0	15	10
50825300483	50825-30	5,5	0,9	36,0	18,0	12,0	15	10
50825300583	50825-30	7,0	1,0	36,0	18,0	12,0	15	10

Bestell-No./Order-No.	Art. No.	mm	L1 mm	L2 mm	D2 mm	g	
50825310183	50825-31	3,0	36,0	17,0	12,0	15	10
50825310283	50825-31	4,0	36,0	17,0	12,0	15	10
50825310383	50825-31	5,0	36,0	17,0	12,0	15	10
50825310583	50825-31	5,5	36,0	17,0	12,0	15	10
50825310483	50825-31	6,0	36,0	17,0	12,0	15	10

Bestell-No./Order-No.	Art. No.		L1 mm	L2 mm	D2 mm	g	
50825320183	50825-32	PH 1	36,0	17,0	12,0	15	10
50825320283	50825-32	PH 2	36,0	17,0	12,0	15	10
50825320383	50825-32	PH 3	36,0	17,0	12,0	15	10

Bestell-No./Order-No.	Art. No.		L1 mm	L2 mm	D2 mm	g	
50825330183	50825-33	M5	36,0	17,0	12,0	15	10
50825330283	50825-33	M6	36,0	17,0	12,0	15	10
50825330383	50825-33	M8	36,0	17,0	12,0	15	10

Bestell-No./Order-No.	Art. No.		L1 mm	L2 mm	D2 mm	g	
50825350183	50825-35	PZ 1	36,0	17,0	12,0	15	10
50825350283	50825-35	PZ 2	36,0	17,0	12,0	15	10
50825350383	50825-35	PZ 3	36,0	17,0	12,0	15	10

Bestell-No./Order-No.	Art. No.		mm	L1 mm	L2 mm	D2 mm	g	
50825370883	50825-37	TT 8	2,52	37,0	17,0	12,0	15	10
50825371083	50825-37	TT 10	2,68	37,0	17,0	12,0	15	10
50825371583	50825-37	TT 15	3,48	37,0	17,0	12,0	15	10
50825372083	50825-37	TT 20	3,75	37,0	17,0	12,0	15	10
50825372583	50825-37	TT 25	4,25	37,0	17,0	12,0	15	10
50825372783	50825-37	TT 27	5,00	37,0	17,0	12,0	15	10
50825373083	50825-37	TT 30	5,55	37,0	17,0	12,0	15	10
50825374083	50825-37	TT 40	6,50	37,0	17,0	12,0	15	10

50825-1501

DIN 3123 A · ISO 3316

Adapter

Converter

Adapter

Réducteur

Reductor



Bestell-No./Order-No.	Art. No.	■	□	CL Ø mm	⚖	📦
50825150183	50825-1501	3/8"	1/4"	25	21	10

50800-3306

Adapter für 1/4" Bits

Innensechskant, mit Halteklammer

Adapter for 1/4" bits

Internal hexagon with holding clip

Adapter voor 1/4" bits

Met binnenzeskant, met klem

Adaptateur pour embouts 1/4"

6-pans femelle, avec clavette de blocage

Adaptador para puntas de 1/4"

Exágono interior, con pinza de sujeción



Bestell-No./Order-No.	Art. No.	□	CL Ø mm	⚖	📦
50800330683	50800-3306	1/4"	25	20	10

5083301-1

Magnet Bithalter

Mit Dauermagnet. Sicherheitsarretierung durch Dauermagnet und formschlüssige Arretierung. Einfache Entnahme durch Auswurfbetätigung.

Magnetic bitholder

With permanent magnet. Safety locking by permanent magnet and positive locking. Easy removal by actuating the ejection.

Bitadapter

Met permanente magneet. Bit blijft op zijn plek dankzij permanente magneet en minimale speling tussen bit en bithouder. Eenvoudig uitnemen van de bit door uitwerpmecanisme.

Adaptateur magnétique pour embouts

Aimant permanent. Verrouillage de sécurité par l'aimant permanent et verrouillage positif. Démontage facile par opération d'éjection.

Adaptador de puntas

Con imán permanente. Bloqueo de seguridad mediante imán permanente y sujeción precisa. Fácil extracción por expulsor.



Chrom-Molybdän, verchromt. Mit ergonomischem 2-K Griff.
Chrom-molybdenum, chromium. With ergonomic 2 components handle.

Extrem schmale Ausführung. Ideal geeignet für enge, schwer zugängliche Stellen.
Extremely slim shape. Best suited for tight places with difficult access.

Bestell-No./Order-No.	Art. No.	CL Ø mm	⚖	📦
50833010080	5083301-1	200	240	1

50850-1601

Bit Adapter, Vierkantantrieb

Chrom-Vanadium-Stahl, Ausführung verchromt mit Haltekugel.

Bit adapter, square drive

Chrome vanadium steel, chrome-plated finish with retaining ball.

Bit adapter, vierkant-aansluiting

Chroom-Vanadium, verchromd, met kogel.

Porte-embouts

Avec entraînement carré, chrome vanadium, finition chromée, avec bille de blocage.

Adaptador de broca, cuadrado

Acero cromo vanadio, acabado cromado con bola de retención.



Sechskantantrieb für die Aufnahme von handelsüblichen Bits. Mit diesem Adapter können 1/4" Sechskant Bits mit Akkuschauber mit 1/2" Vierkantantrieb betätigt werden. Besonders geeignet für Trockenbauer, Zimmermann, Dachdecker und Gartenlandschaftsbau.

Hexagonal drive for accepting commercially available bits. With this adapter, 1/4" hexagon bits can be operated with cordless screwdrivers with 1/2" square drive. Particularly suitable for drywallers, carpenters, roofers and garden landscaping.

Bestell-No./Order-No.	ØMM	■	CL Ø mm	⚖	📦
50850160183	1/4" (6,3 mm)	1/2" (12,5 mm)	38,12	60	10



Chrom-Vanadium, verchromt
 Chrome-Vanadium, chromium plated
 Chrom-Vanadium, verchromd
 Chrome-Vanadium, chromées
 Cromo Vanadio, cromadas



50825-71 - 50825-37

Chrom-Vanadium, verchromt
 Halterung mit Sicherungssperre
 Chrome-Vanadium, chromium plated
 Holder with safety lock
 Chrom-Vanadium, verchromd
 Houder met vergrendeling
 Chrome-Vanadium, chromées
 Rack avec blocage
 Cromo Vanadio, cromadas
 Soporte con cierre de seguridad



Steckschlüsseleinsätze mit Schonprofil und Kreuzrändelung.
 Sockets with profile saver and cross knurling.



Entriegelung der Sicherungssperre durch einfaches Abknipsen des überstehenden Hakens.
 Unlocking the holder through removing the protruding hook.

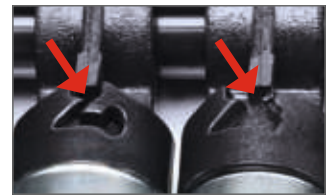

Links: Verriegelte Sicherungssperre
 Rechts: Entsicherte Sperre
 Left: locked
 Right: unlocked



50825-7100

13-tlg./pcs./-dlg./pces./pzs.

Satz mit Steckschlüssel-einsätzen

Socket set

Dopsleutelset

Composition de douilles

Conjunto de llaves de vaso



Bestell-No./Order-No.

50825710083



4/4,5/5/5,5/6/7/8/9/
10/11/12/13/14

Maße - Dimensions

280 x 75 mm



300



1



50825-7137

8-tlg./pcs./-dlg./pces./pzs.

Satz mit Schraubendreher-einsätzen

Screwdriver socket set

Schroevendraaier dops-leutelset

Composition de douilles tournevis

Conjunto de llaves de vaso con destornillador



Bestell-No./Order-No.		Maße - Dimensions		
50825713783	TT 8/10/15/20/25/27/30/40	230 x 80 mm	180	1



50825-7119

9-tlg./pcs./-dlg./pces./pzs.

Satz mit Steckschlüssel-einsätzen, extra lang

Socket set, extra long

Dopsleutelset, verlengd

Composition de douilles, extra longues

Conjunto de llaves de vaso, extra-largas



Bestell-No./Order-No.		Maße - Dimensions		
50825711983	6/7/8/9/10/11/12/13/14	230 x 100 mm	420	1



50825-7199

13-tlg./pcs./-dlg./pces./pzs.

Satz mit Schraubendreher-einsätzen

Screwdriver socket set

Schroevendraaier dops-leutelset

Composition de douilles tournevis

Conjunto de llaves de vaso con destornillador



Bestell-No./Order-No.					Maße - Dimensions		
50825719983	4/5,5/7 mm	3/4/5/6 mm	TT 15/20/25/30	1/2	280 x 80 mm	280	1



Chrom-Vanadium, verchromt
 Chrome-Vanadium, chromium plated
 Chroom-Vanadium, verchromd
 Chrome-Vanadium, chromées
 Cromo Vanadio, cromadas

9083312-3

Adapter-Satz, 3-tlg.

Chrom-Vanadium-Stahl, gesandstrahlt,
 1/2", 3/8", 1/4", Vierkant mit
 Kugelarretierung, 1/4" (6,3 mm)
 Sechskant Antrieb für Bohrmaschine und
 Akkuschauber.

Adapter-set, 3 pcs.

Chrome-Vanadium steel, sand blasted,
 1/2", 3/8", 1/4" square drive with ball
 stop, 1/4" (6.3 mm) hexagon drive for
 electric powered tools.

Adapterset, 3-dlg.

Chroom-vanadium, gezandstraalt,
 1/2", 3/8", 1/4", vierkant met
 kogelvergrendeling, voor boormachine en
 accu-schroevendraaier, 1/4" (6,3 mm)
 zeskant aansluiting.

Jeu d'adaptateurs, 3 pcs

En Chrome Vanadium. 1/2", 3/8",
 1/4", avec bille de blocage, pour
 perceuses et visseuses électriques,
 entraînement hexagonal 1/4" (6,3 mm).

Juego de 3 adaptadores

Acero al cromo vanadio, granulado
 de 1/2", 3/8", 1/4". Cuadradillo con
 bola de fijación de bola para taladros
 y atornilladores inalámbricos, punta
 hexagonal de 1/4" (6,3 mm).



Bestell-No./Order-No.	■	CLD mm	△g	△g	📦
90833120305	1/4"	64	21	100	10
	3/8"	64	32		
	1/2"	73	47		

50833-465

Bit-Adapter

für Bohrmaschinen und Akkuschauber

Chrom-Vanadium, verchromt, extra
 schlanke Ausführung mit magnetischer
 und formschlüssiger Arretierung. Für enge
 Bauräume.

Bit-Adapter

for drilling machines and cordless screwdrivers

Chrome-Vanadium, chromium plated, extra
 slim version with magnetic, form-fit locking.
 For tight installation spaces.

Bit adapter

voor boor- en accuboormachines

Chroom-Vanadium, verchromd, extra
 slanke uitvoering met magnetische en
 vormvaste vergrendeling. Ideaal voor
 krappe bouwruimtes. Ideaal voor krappe
 bouwruimtes.

Porte-embouts tournevis

pour perceuses et visseuses

Chrome-Vanadium, chromées, exécution
 extra mince avec blocage magnétique.
 Idéal pour les petits espaces.

Adaptador para puntas en

taladros

y destornilladores eléctricos

Acero al cromo-vanadio, cromado, diseño
 extra delgado, con sujeción imantada.
 Ideal para trabajo en espacios reducidos.

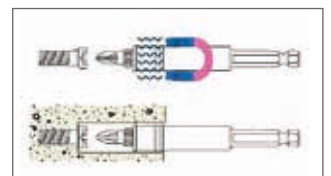

Bestell-No./Order-No.	Art. No.	CLD mm	U	△g	📦
50833046500	50833-465	95	250 g	71	1



50825-3015

44-tlg./pcs./-dlg./pces./pzs.

Steckschlüsselgarnitur

Chrom-Vanadium, verchromt, in Kunststoffkoffer.

Socket set

Chrome-Vanadium, chromium plated, in plastic box.

Dopsleutelset

Chroom-Vanadium, verchromd, in kunststof koffer.

Composition de douilles

Chrome-Vanadium, chromé, en coffret plastique.

Conjunto de llaves de vaso

Cromo Vanadio, cromadas, en caja de plástico.



enthaltend/containing	
	150 mm
	150 mm
	MM 4/4,5/5/5,5/6/7/8/9/10/11/12/13
	MM 6/7/8/9/10/11/12/13
	50 / 100 mm
	37 mm
	M 5/6/8
	PH 1/2/3
	3/4/5/6
	4/5,5
	TT 10/15/20/25/27/30/40

Bestell.-No./Order-No.	Art. No.	Maße - Dimensions		
50825301583	50825-3015	280 x 220 x 60 mm	1600	1

50828-3015

29-tlg./pcs./-dlg./pces./pzs.

T-Griff Steckschlüssel-Garnitur

Chrom-Vanadium, verchromt, mit 2-K Schaumstoffeinlage in Metallkasten.

T-Handle socket set

Chrome-Vanadium, chromium plated, with 2 components foam insert in metal case.

Dopsleutelset, T-greep met ratelfunctie

Chroom-Vanadium, verchromd, met 2 componenten schuimleg in metalen koffer.

Composition de douilles avec manche-T

Chrome-Vanadium, chromées, avec plateau mousse bicolore, en coffret métallique.

Juego de llaves de tubo con mango en T

Cromo Vanadio, cromadas, con material de espuma 2 componentes alta gama en caja metálica.



enthaltend/containing	
	115 mm
	MM 4/4,5/5/5,5/6/7/8/9/10/11/12/13
	100 / 250 mm
	37 mm
	PZ 1/2
	3/4/5/6
	4/5,5
	TT 15/20/25/27/30/40



Bestell.-No./Order-No.	Art. No.	Maße - Dimensions		
50828301583	50828-3015	407 x 162 x 52 mm	1860	1



Chrom-Vanadium, verchromt
 Chrome-Vanadium, chromium plated
 Chrom-Vanadium, verchromd
 Chrome-Vanadium, chromées
 Cromo Vanadio, cromadas

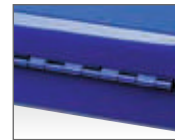

50829-3016

45-tlg./pcs./-dlg./pces./pzs.

Steckschlüsselgarnitur

Chrom-Vanadium, verchromt, mit 2-K
 Schaumstoffeinlage in Metallkasten.

Socket set

Chrome-Vanadium, chromium plated, with
 2 components foam insert in metal case.

Dopsleutelset

Chrom-Vanadium, verchromd, met 2
 componenten schuimleg in metalen koffer.

Composition de douilles

Chrome-Vanadium, chromées, avec
 intérieur mousse à 2 composantes en
 coffret métallique.

Conjunto de llaves de vaso

Cromo Vanadio, cromadas, con material
 de espuma 2 componentes alta gama en
 caja metálica.



enthaltend/containing	
	150 mm
	115 mm
	150 mm
	37 mm
	50 mm
	MM 4/4,5/5/5,5/6/7/8/9/ 10/11/12/13/14
	PZ 1/2/3
	PH 1/2/3
	3/4/5/6
	4/5,5/7
	TT 8/10/15/20/25/ 27/30/40
	E 4/5/6/7/8/10

Bestell-No./Order-No.	Art. No.	Maße · Dimensions		
50829301683	50829-3016	320 x 140 x 55 mm	2180	1

50829-3017

22-tlg./pcs./-dlg./pces./pzs.

Steckschlüssel- und Bitsgarnitur

Chrom-Vanadium, verchromt,
 in Kunststoffkoffer.

Socket- and bit-set

Chrome-Vanadium, chromium plated,
 in plastic box.

Dopsleutel- en bitset

Chrom-Vanadium, verchromd,
 in kunststof koffer.

Composition de douilles et embouts

Chrome-Vanadium, chromées,
 en coffret plastique.

Conjunto de llaves de vaso y bits

Cromo Vanadio, cromadas,
 en caja de plástico.



enthaltend/containing	
	140 mm
	MM 5/6/7/8/10/11/12/13
	50 mm
	50 mm
	1/4"
	100 mm
	PH 1/2
	4/5,5
	TT 10/15/20/25/27

Mit arretierbarer Gelenkknarre + Gürtelclip.
 With articulated lockable ratchet plus belt clip.



Bestell-No./Order-No.	Art. No.	Maße · Dimensions		
50829301783	50829-3017	160 x 102 x 36 mm	575	1

50829-3019

25-tlg./pcs./-dlg./pces./pzs.

Steckschlüsselgarnitur

Chrom-Vanadium, verchromt, mit 2-K
 Schaumstoffeinlage in Kunststoffbox.

Socket set

Chrome-Vanadium, chromium plated, with
 2 components foam insert in plastic box.

Dopsleutelset

Chrom-Vanadium, verchromd, met 2
 componenten schuimleg in kunststof koffer.

Composition de douilles

Chrome-Vanadium, chromées, avec
 intérieur mousse à 2 composantes en
 coffret plastique.

Conjunto de llaves de vaso

Cromo Vanadio, cromadas, con material
 de espuma 2 componentes alta gama en
 caja de plástico.



enthaltend/containing	
	MM 4/4,5/5/5,5/6/7/8/9/ 10/11/12/13
	115 mm
	100 mm
	1/4"
	PZ 2
	PH 2
	5/6
	TT 10/15/20/25/30/40

Bestell-No./Order-No.	Art. No.	Maße · Dimensions		
50829301983	50829-3019	145 x 102 x 50 mm	775	1

50829-3018

44-tlg./pcs./-dlg./pces./pzs.

Steckschlüssel- und Bitsgarnitur

Chrom-Vanadium, verchromt, mit 2-K Schaumstoffeinlage in Kunststoffbox.

Socket- and bit-set

Chrome-Vanadium, chromium plated, with 2 components foam insert in plastic box.

Dopsleutel- en bitset

Chroom-Vanadium, verchromd, met 2 componenten schuimleg in kunststof koffer.

Composition de douilles et embouts

Chrome-Vanadium, chromées, avec intérieur mousse à 2 composantes, en coffret plastique.

Conjunto de llaves de vaso y bits

Cromo Vanadio, cromadas, con material de espuma 2 componentes alta gama en caja de plástico.



enthaltend/containing	
	115 mm
	MM 6 - 13
	50 mm
	1/4"
	100 mm
	110 mm
	85 mm
	PZ 1/2/2/3/4
	PH 1/2/2/3
	2/3/4/5/6/7/8
	3,5/4,5/5,5/6,5
	TT 7/8/9/10/15/20/25/27/30/40

Bestell-No./Order-No.	Art. No.	Maße · Dimensions		
50829301883	50829-3018	145 x 102 x 50 mm	765	1

50829-3020

46-tlg./pcs./-dlg./pces./pzs.

Steckschlüssel- und Bitsgarnitur

Hochwertiger Chrom-Vanadium Stahl DIN 3123 B · ISO 3316. Einsätze mit Schraubenschonprofil. Adapter für 1/4" Bits. Top Finish. Ergonomischer Softgriff. Hochwertiger 2-Komponenten Schaumstoff. In Kunststoffbox.

Socket- and bit-set

High grade chrome vanadium steel DIN 3123 B · ISO 3316. Profile saver sockets. Adapter for 1/4" bits. Top Finish. Ergonomically designed soft grip handle. High grade 2 components foam material. In plastic box.

Dopsleutel- en bitset

Hoogwaardig chroom- vanadium staal DIN 3123 B · ISO 3316. Dopsleutels met profiel-bescherming. Adapter voor 1/4" bits. Top Finish. Ergonomische soft grip. Hoogwaardig 2-comp. schuimstof, in kunststof koffer.

Composition de douilles et embouts

Chrome vanadium de haute qualité. Acier DIN 3123 B · ISO 3316. Adaptateur pour 1/4" embouts. Finition supérieure. Soft grip ergonomique. Matériel mousse 2 composants de haute qualité. Boîte plastique.

Conjunto de llaves de vaso y bits

Acero al cromo vanadio de gran calidad, acero DIN 3123 B · ISO 3316. Llaves de vaso con perfil especial. Adaptador para bits de 1/4". Acabado óptimo. Mango ergonómico. Plástico expandido de 2 componentes de alta calidad. En estuche de plástico.



enthaltend/containing	
	115 mm
	100 mm
	65 mm
	MM 4/4,5/5/5,5/6/7/8/9/10/11/12/13
	1/4"
	2/3/4/5/6/7/8
	PH 1/2/2/3
	PZ 1/2/2/3/4
	3,5/4,5/5,5/6,5
	TT 7/8/9/10/15/20/25/27/30/40

Hebelumschaltknarre, mit Auswerferstift zum Schnellösen der Steckverbindung, 48 Zähne.
Lever type reversible ratchet, with quick release ejector button, 48 teeth.

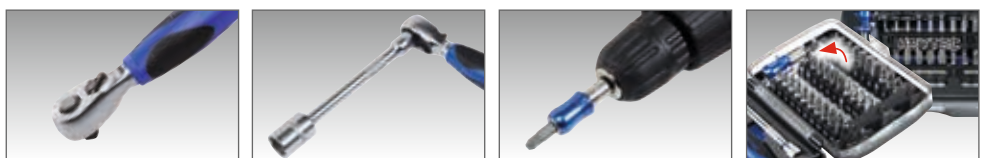

Bestell-No./Order-No.	Art. No.	Maße · Dimensions		
50829302083	50829-3020	145 x 105 x 50 mm	700	1



Chrom-Vanadium, verchromt
 Chrome-Vanadium, chromium plated
 Chrom-Vanadium, verchromd
 Chrome-Vanadium, chromées
 Cromo Vanadio, cromadas



Hebelumschaltknarre
 Lever type reversible ratchet
 Omschakelbare ratel
 Cliquets réversibles
 Carraca reversible

50840-00-15

DIN 3122 D · ISO 3315

48 Zähne/teeth/tanden/dents/dientes

Mit Auswerferstift zum Schnelllösen der Steckverbindung. Mit ergonomischem 2-K Griff.

With quick release ejector button. With ergonomic 2 components handle.

Met pal, met ontgrendelstift. Met ergonomische 2 componenten greep.

Tige d'éjection pour libérer rapidement l'outil du cliquet. Avec poignée ergonomique bimatière.

Con expulsor para separación instantánea de vasos y accesorios. Con mango ergonómico de dos componentes.



Bestell-No./Order-No.	Art. No.				
50840015083	50840-00-15	3/8"	200 mm	285 g	5 mm

50840-10-17

60 Zähne/teeth/tanden/dents/dientes

Mit Auswerferstift zum Schnelllösen der Steckverbindung. Mit ergonomischem 2-K Griff. 30% mehr Drehmoment durch innovative Sperrfunktion.

With quick release ejector button. With ergonomic 2 components handle. Innovative locking function for 30% higher torque.

Met pal, met ontgrendelstift. Met ergonomische 2 componenten greep. 30% meer draaimoment door innovatieve blokkeerfunctie.

Tige d'éjection pour libérer rapidement l'outil du cliquet. Avec poignée ergonomique bimatière. 30% plus de couple grâce à la fonction de blocage innovante.

Con expulsor para separación instantánea de vasos y accesorios. Con mango ergonómico de dos componentes. Par de apriete aumentado en un 30% gracias a la función de bloqueo innovador.



	NORMAL	HEYTEC	Gewicht/ weight %
1/4"	128 g	89 g	-30%
3/8"	315 g	217 g	-30%
1/2"	645 g	442 g	-30%

Extrem schlank, bestens geeignet für enge Bauräume.
 Extremely slim, best suited for places of hard access.

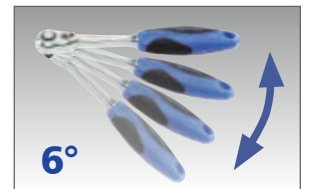

Bestell-No./Order-No.	Art. No.				
50840101783	50840-10-17	3/8"	205 mm	280 g	5 mm

50840-03

DIN 3122 A · ISO 3315

Griff mit Gleitstück
Sliding Thandle
Greep met schuifstuk
Poignée coulissante
Mango corredizo



Bestell-No./Order-No.	Art. No.			CL mm		
50840030083	50840-03		3/8"	150	205	10

50840-04-1/04

DIN 3123 B · ISO 3316

Verlängerungen
Extension bars
Verlengstukken
Rallonges
Alargaderas



50840-04-1

50840-04

Bestell-No./Order-No.	Art. No.			CL mm		
50840041083	50840-04-1		3/8"	75	75	10
50840040083	50840-04		3/8"	150	140	10

50840-06

DIN 3123 C · ISO 3316

Kardangelenk
Universal joint
Kardangewricht
Cardan universel
Articulaciones universales



Bestell-No./Order-No.	Art. No.			CL mm		
50840060083	50840-06		3/8"	55	65	10

50840-14/50840-15

DIN 3123 A · ISO 3316

Adapter
Converter
Adapter
Réducteur
Reductor



Bestell-No./Order-No.	Art. No.			CL mm		
50840140083	50840-14	3/8"	1/4"	25	68	10
50840150083	50840-15	3/8"	1/2"	45	70	10

50850-14-1

DIN 3123 A · ISO 3316

Gleitstück für Verlängerung
Sliding Thread / Adapter
Schuifstuk voor verlengstuk
Coulisseau à adapter
Conexión corrediza para adaptador



Bestell-No./Order-No.	Art. No.			CL mm		
50850141083	50850-14-1	1/2"	3/8"	40	70	10



Chrom-Vanadium, verchromt
 Chrome-Vanadium, chromium plated
 Chrom-Vanadium, verchromd
 Chrome-Vanadium, chromées
 Cromo Vanadio, cromadas

50840-14/50840-15
 DIN 3123 A · ISO 3316

Adapter
 Converter
 Adapter
 Réducteur
 Reductor



Bestell-No./Order-No.	Art. No.			CLD mm		
50840140183	50840-1401	3/8"	1/4"	25	19	10

50840-1501
 DIN 3123 A · ISO 3316

Adapter
 Converter
 Adapter
 Augmentateur
 Reductor



Bestell-No./Order-No.	Art. No.			CLD mm		
50840150183	50840-1501	1/2"	3/8"	35	43	10

50840-6
 DIN 3124 / ISO 2725

Steckschlüsseleinsätze,
 sechskant

Chrom-Vanadium, verchromt

Sockets, hexagon

Chrome-Vanadium, chromium plated

Dopsleutels, zeskant

Chrom-Vanadium, verchromd

Douilles, 6 pans

Chrome-Vanadium, chromées

Llaves de vaso, boca hexagonal

Cromo Vanadio, cromadas

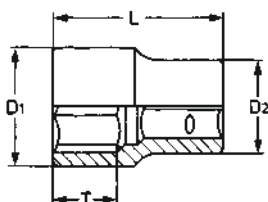

Bestell-No./Order-No.		CLD mm	T mm	D1 mm	D2 mm		
50840600883	8	25,5	10,0	12,5	12,0	20	10
50840600983	9	28,0	10,0	17,0	13,0	22	10
50840601083	10	28,0	12,0	14,5	17,0	23	10
50840601183	11	25,5	12,0	15,5	17,0	24	10
50840601283	12	25,5	10,0	17,0	17,0	25	10
50840601383	13	25,5	11,0	18,5	17,0	26	10
50840601483	14	25,5	15,0	20,0	18,0	30	10
50840601583	15	25,5	15,0	21,0	19,5	33	10
50840601683	16	25,5	16,0	22,0	19,5	34	10
50840601783	17	25,5	17,0	23,0	20,0	35	10
50840601883	18	26,0	17,0	24,5	21,0	40	10
50840601983	19	26,5	17,0	26,0	23,0	46	10
50840602083	20	32,0	18,0	27,0	24,0	68	10
50840602183	21	32,0	18,0	28,0	25,0	70	10
50840602283	22	32,0	18,0	29,5	26,5	82	10
50840602483	24	32,0	18,0	32,0	28,0	95	10

50840-19-1/50840-19-3
DIN 3124 / ISO 2725

Zündkerzeneinsätze

Chrom-Vanadium, verchromt mit Gummisicherung

Spark plug sockets

Chrome-Vanadium, chromium plated with rubber insert

Bougiedopsleutel

Chroom-Vanadium, verchromd met rubber inleg

Douilles pour bougies

Chrome-Vanadium, chromées avec bague de caoutchouc

Llaves de vaso, para bujías

Cromo Vanadio, cromadas con injerto de goma

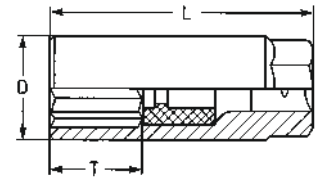

Bestell-No./Order-No.	ØMM	GLD mm	T mm	D mm	ØMM	g	mm
50840190183	20,8	70,0	25,0	27,0	24	160	10
50840190383	16	65,0	20,0	22,5	19	100	10

50840-3015

23-tlg./pcs./-dlg./pces./pzs.

Steckschlüsselgarnitur

Chrom-Vanadium, verchromt, in Kunststoffkoffer.

Socket set

Chrome-Vanadium, chromium plated, in plastic box.

Dopsleutelset

Chroom-Vanadium, verchromd, in kunststof koffer.

Composition de douilles

Chrome-Vanadium, chromées, en coffret plastique.

Conjunto de llaves de vaso

Cromo Vanadio, cromadas, en caja de plástico.



enthaltend/containing

	200 mm
	MM 8/9/10/11/12/13/14/15/16/17/18/19/20/21/22/24
	MM 16/20,8
	150 mm
	75 mm
	55 mm

Bestell-No./Order-No.	Art. No.	Maße · Dimensions	g	mm
50840301583	50840-3015	280 x 220 x 60 mm	2000	1

50842-3015

15-tlg./pcs./-dlg./pces./pzs.

Steckschlüsselgarnitur

Chrom-Vanadium, verchromt, in Metallkasten.

Socket set

Chrome-Vanadium, chromium plated, in metal case.

Dopsleutelset

Chroom-Vanadium, verchromd, in metalen koffer.

Composition de douilles

Chrome-Vanadium, chromées, en coffret métallique.

Conjunto de llaves de vaso

Cromo Vanadio, cromadas, en caja metálica.



enthaltend/containing

	MM 8/10/12/13/14/15/17/19/21/22/24
	200 mm
	75 / 150 mm
	55 mm

Bestell-No./Order-No.	Art. No.	Maße · Dimensions	g	mm
50842301583	50842-3015	250 x 150 x 40 mm	1650	1



Chrom-Vanadium, verchromt
 Chrome-Vanadium, chromium plated
 Chrom-Vanadium, verchromd
 Chrome-Vanadium, chromées
 Cromo Vanadio, cromadas



Durchsteckknarre
 Ratchet
 Doorsteekratel
 Cliquet
 Carraca



50750-01
 DIN 3122 C

Mit Verbindungsvierkant, 2-tlg.
 With square coupler, 2 pcs.
 Met verbindingsvierkant, 2 dlg.
 Avec carré conducteur, 2 pcs.
 Pasante de acoplamiento cuadrado 2 pzs.



Bestell-No./Order-No.	Art. No.				
50750010080	50750-01	1/2"	260	490	5

50750-01-1
 DIN 3122 C

Ohne Verbindungsvierkant
 Without square coupler
 Zonder verbindingsvierkant
 Sans carré conducteur
 Sin cuadradillo



Bestell-No./Order-No.	Art. No.			
50750010180	50750-01-1	260	430	5

90050-16
 DIN 3122 CV · ISO 3315

Verbindungsvierkant
 für 1/2" Verbindungen
 Square coupler
 plated, for 1/2" connections
 Verbindingsvierkant
 voor 1/2" hulpstukken
 Carré conducteur
 pour 1/2" connexions
 Adaptador
 para 1/2" conexions



Bestell-No./Order-No.	Art. No.				
90050160083	90050-16	1/2"	37	45	10

Hebelumschaltknarre

Lever type reversible ratchet

Omschakelbare ratel

Cliquets réversibles

Carraca reversible

50850-00-15

DIN 3122 D · ISO 3315

48 Zähne/teeth/tanden/dents/dientes

Mit Auswerferstift zum Schnelllösen der Steckverbindung. Mit ergonomischem 2-K Griff.

With quick release ejector button. With ergonomic 2 components handle.

Met ontgrendelstift. Met ergonomische 2 componenten greep.

Tige d'éjection pour libérer rapidement l'outil du cliquet. Avec poignée ergonomique bimatière.

Con expulsor para separación instantánea de vasos y accesorios. Con mango ergonómico de dos componentes.



Bestell-No./Order-No.	Art. No.		CL mm		
50850015083	50850-00-15	1/2"	250	555	5

50850-10-16

72 Zähne/teeth/tanden/dents/dientes

Mit Auswerferstift zum Schnelllösen der Steckverbindung. Gebogener Stahlkern.

With quick release ejector button. Offset handle.

Met ontgrendelstift. Gebogen stalen kern.

Tige d'éjection pour libérer rapidement l'outil du cliquet. Poignée courbée en acier.

Con expulsor para separación instantánea de vasos y accesorios. Mango acodado.



Bestell-No./Order-No.	Art. No.		CL mm		
50850101680	50850-10-16	1/2"	255	510	5

50850-10-17

60 Zähne/teeth/tanden/dents/dientes

Mit Auswerferstift zum Schnelllösen der Steckverbindung. Mit ergonomischem 2-K Griff. 30% mehr Drehmoment durch innovative Sperrfunktion.

With quick release ejector button. With ergonomic 2 components handle. Innovative locking function for 30% higher torque.

Met ontgrendelstift. Met ergonomische 2 componenten greep. 30% meer draaimoment door innovatieve blokkeerfunctie.

Tige d'éjection pour libérer rapidement l'outil du cliquet. Avec poignée ergonomique bimatière. 30% plus de couple grâce à la fonction de blocage innovante.

Con expulsor para separación instantánea de vasos y accesorios. Con mango ergonómico de dos componentes. Par de apriete aumentado en un 30% gracias a la función de bloqueo innovador.



	NORMAL	HEYTEC	Gewicht/ weight %
1/4"	128 g	89 g	-30%
3/8"	315 g	217 g	-30%
1/2"	645 g	442 g	-30%

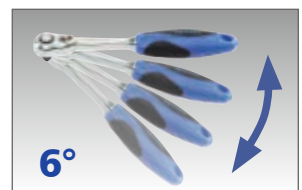

Extrem schlank, bestens geeignet für enge Bauräume.
Extremely slim, best suited for places of hard access.



Bestell-No./Order-No.	Art. No.		CL mm		
50850101783	50850-10-17	1/2"	260	555	5



Chrom-Vanadium, verchromt
 Chrome-Vanadium, chromium plated
 Chrom-Vanadium, verchromd
 Chrome-Vanadium, chromées
 Cromo Vanadio, cromadas

50850-03
 DIN 3122 A · ISO 3315

Griff mit Gleitstück
 Sliding Thandle
 Greep met schuifstuk
 Poignée coulissante
 Mango corredizo



Bestell-No./Order-No.	Art. No.		CLD mm		
50850030083	50850-03	1/2"	250	500	10

50850-04/05
 DIN 3123 B · ISO 3316

Verlängerungen
 Extension bars
 Verlengstukken
 Rallonges
 Alargaderas



50850-04



50850-05



50850-05-54



50850-05-55

Bestell-No./Order-No.	Art. No.		CLD mm		
50850040083	50850-04	1/2"	125	200	10
50850050083	50850-05	1/2"	250	420	10
50850055483	50850-05-54	1/2"	400	670	10
50850055583	50850-05-55	1/2"	500	850	5

50850-04-5/05-5

Schwenkbare
 Verlängerungen
 Wobble extension
 Zwenbare verlengstukken
 Rallonges articulées
 Alargaderas oscilante



50850-04-5



50850-05-5



Bestell-No./Order-No.	Art. No.		CLD mm		
50850045083	50850-04-5	1/2"	125	200	10
50850055083	50850-05-5	1/2"	250	420	10

50850-06
DIN 3123 C · ISO 3316

Kardangeln
Universal joint
Kardangewricht
Cardan universel
Articulaciones universales



Bestell-No./Order-No.	Art. No.		CLD mm		
50850060083	50850-06	1/2"	75	150	10

50850-14-1/50840-15
DIN 3123 A · ISO 3316

Gleitstück für Verlängerung
Sliding Thread / Adapter
Schuifstuk voor verlengstuk
Coulisseau à adapter
Conexión corrediza para adaptador



50850-14-1



50840-15

Bestell-No./Order-No.	Art. No.			CLD mm		
50850141083	50850-14-1	1/2"	3/8"	40	70	10
50840150083	50840-15	3/8"	1/2"	45	70	10

50850-1401
DIN 3123 A · ISO 3316

Adapter
Converter
Adapter
Réducteur
Reductor



Bestell-No./Order-No.	Art. No.			CLD mm		
50850140183	50850-1401	3/8"	1/2"	35	46	10

50850-1501
DIN 3123 A · ISO 3316

Adapter
Converter
Adapter
Réducteur
Reductor



Bestell-No./Order-No.	Art. No.			CLD mm		
50850150183	50850-1501	3/4"	1/2"	50	142	10



Chrom-Vanadium, verchromt
 Chrome-Vanadium, chromium plated
 Chrom-Vanadium, verchromd
 Chrome-Vanadium, chromées
 Cromo Vanadio, cromadas



50850-6

DIN 3124 / ISO 2725

Steckschlüsseleinsätze,
 sechskant

Chrom-Vanadium, verchromt

Sockets, hexagon

Chrome-Vanadium, chromium plated

Dopsleutels, zeskant

Chrom-Vanadium, verchromd

Douilles, 6 pans

Chrome-Vanadium, chromées

Llaves de vaso, boca hexagonal

Cromo Vanadio, cromadas

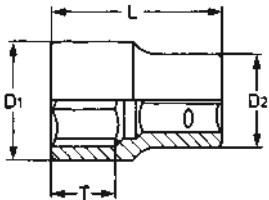

Bestell-No./Order-No.	MM	CLD mm	T mm	D1 mm	D2 mm	g	
50850600883	8	38,5	14,0	13,5	22,0	48	10
50850600983	9	38,5	14,0	14,5	22,0	48	10
50850601083	10	38,5	14,0	15,5	22,0	54	10
50850601183	11	38,5	14,0	16,5	22,0	51	10
50850601283	12	38,5	14,0	17,5	22,0	50	10
50850601383	13	38,5	14,0	18,5	22,0	50	10
50850601483	14	38,5	14,0	20,0	22,0	53	10
50850601583	15	38,5	14,0	21,5	22,0	55	10
50850601683	16	38,5	14,0	22,5	22,0	63	10
50850601783	17	38,5	14,0	24,0	22,5	66	10
50850601883	18	38,5	14,0	25,0	23,0	71	10
50850601983	19	38,5	20,0	25,0	24,5	74	10
50850602083	20	38,5	20,0	28,0	25,5	84	10
50850602183	21	38,5	20,0	28,0	26,5	84	10
50850602283	22	38,5	20,0	30,0	28,0	105	10
50850602383	23	40,0	20,0	32,0	28,0	116	10
50850602483	24	40,5	22,0	32,0	30,0	120	10
50850602783	27	42,5	22,0	36,0	34,0	170	10
50850603083	30	42,5	22,0	40,0	36,5	205	10
50850603283	32	45,0	25,0	42,0	38,0	235	10
50850603483	34	46,0	43,9	37,0	22,0	241	10
50850603683	36	46,0	47,9	37,8	22,0	274	10

50850-6

DIN 3124 / ISO 2725

AF-Größen

Chrom-Vanadium, verchromt

AF-Sizes

Chrome-Vanadium, chromium plated

AF

Chrom-Vanadium, verchromd

AF

Chrome-Vanadium, chromées

AF

Cromo Vanadio, cromadas



Bestell-No./Order-No.	AF	CLD mm	T mm	D1 mm	D2 mm	g	
50850631983	3/8"	38,0	12,0	15,0	22,0	49	10
50850632183	7/16"	38,0	12,0	16,3	22,0	50	10
50850632383	1/2"	38,0	12,0	18,8	22,0	51	10
50850632583	9/16"	38,0	12,0	20,4	22,0	53	10
50850632783	5/8"	38,0	12,0	22,9	22,0	61	10
50850632983	11/16"	38,0	12,0	24,0	22,0	68	10
50850633183	3/4"	38,0	14,0	26,0	23,0	73	10
50850633383	13/16"	38,0	14,0	28,0	25,0	82	10
50850633483	7/8"	40,0	14,0	30,0	26,0	106	10
50850633583	15/16"	42,0	16,0	32,0	28,0	121	10
50850633783	1"	42,0	16,0	34,0	30,0	150	10
50850633883	1.1/16"	43,0	18,0	36,0	30,0	168	10
50850633983	1.1/8"	43,0	20,0	38,0	32,0	205	10
50850634083	1.3/16"	46,0	22,0	40,0	34,0	225	10
50850634183	1.1/4"	46,0	22,0	42,0	36,0	225	10

50850-79/98718-50

Leiste für Steckschlüssel-
 einsätze

Zur Aufnahme von zehn 1/2" Steckschlüssel-
 einsätzen. Die Einsätze und die Leiste werden
 mit Hilfe von Magnetleisten gehalten.

Rail for sockets

A strong magnet securely holds the sockets
 rail to ferrous metal.

Strip voor dopsleutels

Voor 10 dopsleutels 1/2". De dopsleu-
 tels worden door magneten op hun plek
 gehouden.

Rail pour douilles

Rangement pour 10 douilles 1/2".
 Fixation du rail et maintien des douilles
 par le puissant aimantage.

Regla para sujeción

de llaves de vaso
 Barnizado. Regla sujeta por imán.

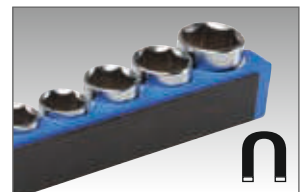
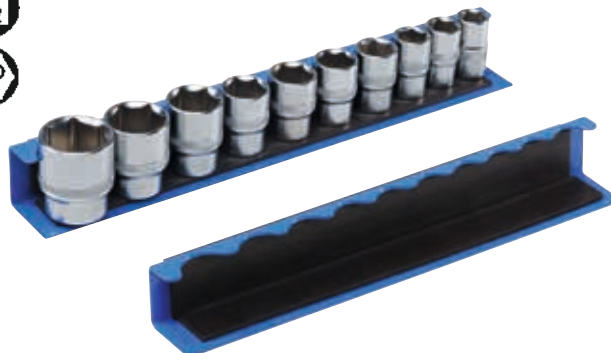

Bestell-No./Order-No.	Art. No.	MM	CLD mm	g	
50850790083	50850-79	10/11/12/13/15/17/19/21/22/24	320	1210	1
* 9871850000	98718-50	leer/empty	320	600	1

* Auslauf / Discontinued

50850-19
DIN 3124 / ISO 2725

Steckschlüsseleinsätze,
extra lang

Chrom-Vanadium, verchromt

Sockets, extra deep

Chrome-Vanadium, chromium plated

Dopsleutels, verlengd

Chroom-Vanadium, verchromd

Douilles, extra longues

Chrome-Vanadium, chromées

Llaves de vaso, extra-largas

Cromo Vanadio, cromadas



Bestell.-No./Order-No.	MM	CL mm	T mm	D1 mm	D2 mm	g	
50850191083	10	77,0	35,0	14,8	22,0	86	10
50850191383	13	77,0	35,0	18,8	22,0	105	10
50850191483	14	77,0	35,0	20,5	22,0	105	10
50850191583	15	77,0	35,0	22,0	22,0	115	10
50850191783	17	77,0	35,0	24,0	22,0	130	10
50850191983	19	77,0	35,0	26,0	23,0	145	10
50850192283	22	77,0	35,0	26,0	24,0	160	10
50850192483	24	77,0	35,0	28,0	24,0	170	10

50850-20

Steckschlüsseleinsätze
für Außen-TORX®-Schrauben

Chrom-Vanadium, verchromt

Sockets for

TORX®-head screws

Chrome-Vanadium, chromium plated

Dopsleutels voor

TORX® bouten

Chroom-Vanadium, verchromd

Douilles pour vis

TORX® extérieures

Chrome-Vanadium, chromées

Llaves de vaso para tornillos

TORX® exteriores

Cromo Vanadio, cromadas

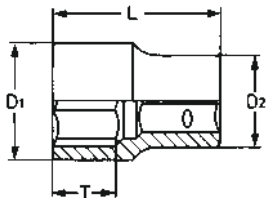

Bestell.-No./Order-No.	E	mm	CL mm	T mm	D1 mm	D2 mm	g	
50850201083	E 10	9,42	38,0	14,0	15,0	22,0	53	10
50850201183	E 11	10,08	38,0	14,0	15,0	22,0	53	10
50850201283	E 12	11,17	38,0	14,0	15,0	22,0	53	10
50850201483	E 14	12,90	38,0	14,0	17,0	22,0	55	10
50850201683	E 16	14,76	38,0	14,0	19,0	22,0	55	10
50850201883	E 18	16,70	38,0	14,0	21,0	24,0	73	10
50850202083	E 20	18,49	38,0	14,0	24,0	22,0	68	10
50850202283	E 22	20,32	38,0	14,0	26,0	23,0	80	10
50850202483	E 24	22,16	38,0	14,0	28,0	24,0	96	10

50850-19-1/50850-19-3
DIN 3124 / ISO 2725

Zündkerzeneinsätze

Chrom-Vanadium, verchromt
mit Gummisicherung

Spark plug sockets

Chrome-Vanadium, chromium plated
with rubber insert

Bougiedopsleutel

Chroom-Vanadium, verchromd
met rubber inleg

Douilles pour bougies

Chrome-Vanadium, chromées
avec bague de caoutchouc

Llaves de vaso, para bujías

Cromo Vanadio, cromadas
con injerto de goma

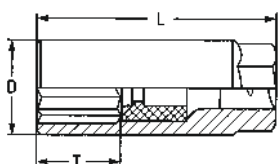

Bestell.-No./Order-No.	Art. No.	MM	AF	CL mm	T mm	D mm	MM	g	
50850190383	50850-19-3	16,0	5/8"	67,0	26,0	22,0	20,0	90	10
50850190483	50850-19-4	18,0	11/16"	67,0	26,0	24,5	22,0	140	10
50850190183	50850-19-1	20,8	13/16"	67,0	26,0	27,5	24,0	130	10



Chrom-Vanadium, verchromt
 Chrome-Vanadium, chromium plated
 Chrom-Vanadium, verchromd
 Chrome-Vanadium, chromées
 Cromo Vanadio, cromadas

50850-31/-33

Schraubendreher-Einsätze

Chrom-Vanadium, verchromt

Screwdriver sockets

Chrome-Vanadium, chromium plated

Schroevendraaier dopseutels

Chrom-Vanadium, verchromd

Douilles tournevis

Chrome-Vanadium, chromées

Llaves de vaso con
destornillador

Cromo Vanadio, cromadas

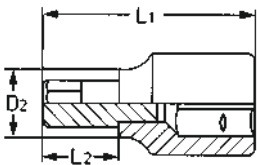

50850-31

50850-33

XZN



Bestell-No./Order-No.	Art. No.	MM	L1 mm	L2 mm	D2 mm		
50850310083	50850-31-0	4	62,0	24,0	18,0	85	10
50850311383	50850-31-13	4	138,0	100,0	18,0	118	5
50850310283	50850-31-2	5	62,0	24,0	18,0	87	10
50850311483	50850-31-14	5	138,0	100,0	18,0	118	5
50850310383	50850-31-3	6	62,0	24,0	18,0	88	10
50850312283	50850-31-22	6	100,0	62,0	18,0	105	5
50850311583	50850-31-15	6	138,0	100,0	18,0	118	5
50850310183	50850-31-1	7	62,0	24,0	18,0	90	10
50850311683	50850-31-16	7	138,0	100,0	18,0	120	5
50850310483	50850-31-4	8	62,0	24,0	18,0	90	10
50850312483	50850-31-24	8	100,0	62,0	18,0	107	5
50850311283	50850-31-12	8	138,0	100,0	18,0	122	5
50850313183	50850-31-31	9	62,0	24,0	18,0	90	10
50850313283	50850-31-32	9	100,0	62,0	18,0	120	5
50850310583	50850-31-5	10	62,0	24,0	18,0	93	10
50850312583	50850-31-25	10	100,0	62,0	18,0	120	5
50850311183	50850-31-11	10	138,0	100,0	18,0	144	5
50850310683	50850-31-6	12	62,0	24,0	20,0	102	10
50850312683	50850-31-26	12	100,0	62,0	20,0	142	5
50850311883	50850-31-18	12	138,0	100,0	20,0	175	5
50850310783	50850-31-7	14	62,0	24,0	22,0	120	10
50850312783	50850-31-27	14	100,0	62,0	22,0	173	5
50850311783	50850-31-17	14	138,0	100,0	22,0	217	5
50850312883	50850-31-28	16	62,0	24,0	26,0	156	10
50850310883	50850-31-8	17	62,0	24,0	26,0	158	10
50850311083	50850-31-10	17	138,0	100,0	26,0	305	5
50850310983	50850-31-9	19	62,0	24,0	26,0	168	10
50850311983	50850-31-19	19	138,0	100,0	26,0	350	5
50850312983	50850-31-29	22	62,0	24,0	26,0	188	10
50850313083	50850-31-30	24	66,0	24,0	26,0	200	10

Bestell-No./Order-No.	Art. No.		L1 mm	L2 mm	D2 mm		
50850330183	50850-33-1	M 5	62,0	24,0	18,0	86	10
50850332183	50850-33-21	M 5	138,0	100,0	18,0	118	5
50850330283	50850-33-2	M 6	62,0	24,0	18,0	88	10
50850331283	50850-33-12	M 6	100,0	62,0	18,0	102	5
50850332283	50850-33-22	M 6	138,0	100,0	18,0	118	5
50850330383	50850-33-3	M 7	62,0	24,0	18,0	88	10
50850332383	50850-33-23	M 7	138,0	100,0	18,0	119	5
50850330483	50850-33-4	M 8	62,0	24,0	18,0	88	10
50850331483	50850-33-14	M 8	100,0	62,0	18,0	104	5
50850332483	50850-33-24	M 8	138,0	100,0	18,0	120	5
50850330583	50850-33-5	M 10	62,0	24,0	18,0	91	10
50850331583	50850-33-15	M 10	100,0	62,0	18,0	118	5
50850332583	50850-33-25	M 10	138,0	100,0	18,0	140	5
50850330683	50850-33-06	M 12	62,0	24,0	20,0	100	10
50850331683	50850-33-16	M 12	100,0	62,0	20,0	139	5
50850332683	50850-33-26	M 12	138,0	100,0	20,0	170	5
50850330783	50850-33-07	M 14	62,0	24,0	22,0	113	10
50850332783	50850-33-27	M 14	138,0	100,0	22,0	212	5

50850-34/-36/-37
Schraubendreher-Einsätze

Chrom-Vanadium, verchromt

Screwdriver sockets

Chrome-Vanadium, chromium plated

Schroevendraaier dopseutels

Chrom-Vanadium, verchromd

Douilles tournevis

Chrome-Vanadium, chromées

 Llaves de vaso con
destornillador

Cromo Vanadio, cromadas

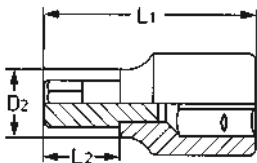
 50850-34
RIBE

 50850-36
TORX®

 50850-37
Tamper TORX®

Bestell-No./Order-No.	Art. No.		L1 mm	L2 mm	D2 mm		
50850340183	50850-34-1	M 5	62,0	24,0	18,0	87	10
50850342183	50850-34-21	M 5	138,0	100,0	18,0	118	5
50850340283	50850-34-2	M 6	62,0	24,0	18,0	88	10
50850342283	50850-34-22	M 6	138,0	100,0	18,0	119	5
50850340383	50850-34-3	M 7	62,0	24,0	18,0	88	10
50850342383	50850-34-23	M 7	138,0	100,0	18,0	119	5
50850340483	50850-34-4	M 8	62,0	24,0	18,0	89	10
50850342483	50850-34-24	M 8	138,0	100,0	18,0	119	5
50850340583	50850-34-5	M 10	62,0	24,0	18,0	91	10
50850342583	50850-34-25	M 10	138,0	100,0	18,0	141	5
50850340683	50850-34-06	M 12	62,0	24,0	20,0	101	10
50850342683	50850-34-26	M 12	138,0	100,0	20,0	173	5
50850340783	50850-34-07	M 14	62,0	24,0	22,0	114	10
50850342783	50850-34-27	M 14	138,0	100,0	22,0	212	5

Bestell-No./Order-No.	Art. No.			L1 mm	L2 mm	D2 mm		
50850362083	50850-36-20	T 20	3,86	62,0	24,0	18,0	86	10
50850361083	50850-36-10	T 20	3,86	138,0	100,0	18,0	117	5
50850362583	50850-36-25	T 25	4,43	62,0	24,0	18,0	86	10
50850361183	50850-36-11	T 25	4,43	138,0	100,0	18,0	119	5
50850362783	50850-36-27	T 27	4,99	62,0	24,0	18,0	86	10
50850361283	50850-36-12	T 27	4,99	138,0	100,0	18,0	119	5
50850363083	50850-36-30	T 30	5,62	62,0	24,0	18,0	87	10
50850360383	50850-36-3	T 30	5,62	100,0	62,0	18,0	100	5
50850361383	50850-36-13	T 30	5,62	138,0	100,0	18,0	118	5
50850364083	50850-36-40	T 40	6,65	62,0	24,0	18,0	88	10
50850360483	50850-36-4	T 40	6,65	100,0	62,0	18,0	102	5
50850361483	50850-36-14	T 40	6,65	138,0	100,0	18,0	120	5
50850364583	50850-36-45	T 45	7,82	62,0	24,0	18,0	88	10
50850361583	50850-36-15	T 45	7,82	138,0	100,0	18,0	120	5
50850365083	50850-36-50	T 50	8,83	62,0	24,0	18,0	90	10
50850360683	50850-36-6	T 50	8,83	100,0	62,0	18,0	115	5
50850361683	50850-36-16	T 50	8,83	138,0	100,0	18,0	120	5
50850365583	50850-36-55	T 55	11,22	62,0	24,0	18,0	92	10
50850361783	50850-36-17	T 55	11,22	138,0	100,0	18,0	142	5
50850366083	50850-36-60	T 60	13,25	62,0	24,0	20,0	100	10
50850360883	50850-36-8	T 60	13,25	100,0	62,0	20,0	138	5
50850361883	50850-36-18	T 60	13,25	138,0	100,0	20,0	173	5
50850367083	50850-36-70	T 70	13,25	62,0	24,0	22,0	114	10
50850361983	50850-36-19	T 70	13,25	138,0	100,0	22,0	213	5

Bestell-No./Order-No.	Art. No.			L1 mm	L2 mm	D2 mm		
50850372083	50850-37-20	TT20	3,86	62,0	24,0	18,0	86	10
50850372583	50850-37-25	TT25	4,43	62,0	24,0	18,0	86	10
50850372783	50850-37-27	TT27	4,99	62,0	24,0	18,0	86	10
50850373083	50850-37-30	TT30	5,62	62,0	24,0	18,0	86	10
50850374083	50850-37-40	TT40	6,65	62,0	24,0	18,0	87	10
50850374583	50850-37-45	TT45	7,82	62,0	24,0	18,0	88	10
50850375083	50850-37-50	TT50	8,83	62,0	24,0	18,0	88	10
50850375583	50850-37-55	TT55	11,22	62,0	24,0	18,0	90	10
50850376083	50850-37-60	TT60	13,25	62,0	24,0	20,0	100	10



Chrom-Vanadium, verchromt
 Chrome-Vanadium, chromium plated
 Chrom-Vanadium, verchromd
 Chrome-Vanadium, chromées
 Cromo Vanadio, cromadas

50872-3015

19-tlg./pcs./dlg./pces./pzs.

50873-3015

21-tlg./pcs./dlg./pces./pzs.

Steckschlüsselgarnitur

Chrom-Vanadium, verchromt,
 in Metallkasten.

Socket set

Chrome-Vanadium, chromium plated,
 in metal case.

Dopsleutelset

Chroom-Vanadium, verchromd,
 in metalen koffer.

Composition de douilles

Chrome-Vanadium, chromées,
 en coffret métallique.

Conjunto de llaves de vaso

Cromo Vanadio, cromadas,
 en caja metálica.



enthaltend/containing

	250 mm
	250 mm 125 mm
	75 mm
	3/8" 1/2"
	MM 10/11/12/13/ 14/15/16/17/19/ 22/24/ 27/30/32

Bestell-No./Order-No.	Art. No.	Maße - Dimensions		
50872301583	50872-3015	407 x 162 x 52 mm	3910	1



enthaltend/containing

wie - as 50872-3015 +	
	MM 16/20,8

Bestell-No./Order-No.	Art. No.	Maße - Dimensions		
50873301583	50873-3015	407 x 162 x 52 mm	4130	1

50853-3015

39-tlg./pcs./dlg./pces./pzs.

Steckschlüsselgarnitur

Chrom-Vanadium, verchromt,
 in Kunststoffkoffer.

Socket set

Chrome-Vanadium, chromium plated,
 in plastic box.

Dopsleutelset

Chroom-Vanadium, verchromd,
 in kunststof koffer.

Composition de douilles

Chrome-Vanadium, chromées,
 en coffret plastique.

Conjunto de llaves de vaso

Cromo Vanadio, cromadas,
 en caja de plástico.



enthaltend/containing

	250 mm
	250 mm
	125 mm
	75 mm
	MM 10/11/12/13/14/15/ 16/17/18/19/20/21/22/ 23/24/27/30/32
	MM 16/20,8
	MM 10/13/17/19
	CL 62 mm 5/6/8/10/12/14
	CL 62 mm TT 30/40/45/50

Bestell-No./Order-No.	Art. No.	Maße - Dimensions		
50853301583	50853-3015	350 x 280 x 80 mm	5500	1



50852-2016

21-tlg./pcs./dlg./pcs./pzs.



Steckschlüsselgarnitur, AF

Chrom-Vanadium, verchromt, mit 2-K Schaumstoffeinlage in Metallkasten.

Socket set, AF

Chrome-Vanadium, chromium plated, with 2 componenten schuiminleg in metalen koffer.

Dopsleutelset, AF

Chroom-Vanadium, verchromd, met 2 componenten schuiminleg in metalen koffer.

Composition de douilles, AF

Chrome-Vanadium, chromées, avec plateau mousse bicolore, en coffret métallique.

Conjunto de llaves de vaso, AF

Cromo Vanadio, cromadas, con material de espuma 2 compo-santes alta gama en caja metálica.



enthaltend/containing	
	255 mm
	250 mm
	125 mm
	75 mm
	AF 3/8" / 7/16" / 1/2" / 9/16" / 5/8" / 11/16" / 3/4" / 13/16" / 7/8" / 15/16" / 1" / 1.1/16" / 1.1/8" / 1.3/16" / 1.1/4"
	AF 5/8" / 13/16"

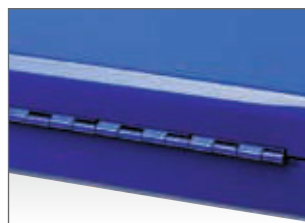

Bestell-No./Order-No.	Art. No.	Maße · Dimensions		
* 50852201683	50852-2016	440 x 180 x 55 mm	5180	1

* Auslauf / Discontinued



Chrom-Vanadium, verchromt
 Chrome-Vanadium, chromium plated
 Chrom-Vanadium, verchromd
 Chrome-Vanadium, chromées
 Cromo Vanadio, cromadas

50854-3016

28-tlg./pcs./-dlg./pces./pzs.



Steckschlüsselgarnitur

Chrom-Vanadium, verchromt, mit 2-K Schaumstoffeinlage in Metallkasten.

Socket set

Chrome-Vanadium, chromium plated, with 2 components foam insert in metal case.

Dopsleutelset

Chrom-Vanadium, verchromd, met 2 componenten schuimleg in metalen koffer.

Composition de douilles

Chrome-Vanadium, chromées, avec plateau mousse bicolore, en coffret métallique.

Conjunto de llaves de vaso

Cromo Vanadio, cromadas, con material de espuma 2 compo-santes alta gama en caja metálica.



enthaltend/containing

	255 mm		MM 10/11/12/13/14/15/16/17/18/19/20/21/22/23/24/27/30/32
	250 mm		MM 16/20,8
	125 mm		MM 10/13/17/19
	75 mm		

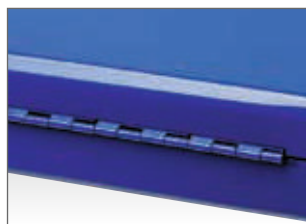
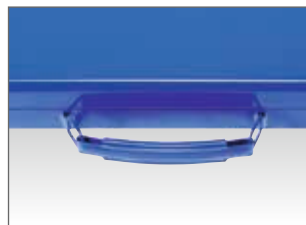

Bestell-No./Order-No.

50854301683

Art. No.

50854-3016

Maße · Dimensions

440 x 180 x 55 mm



5670



1

50883-3016

61-tlg./pcs./dlg./pcs./pzs.



Steckschlüsselgarnitur

Chrom-Vanadium, verchromt, mit 2-K Schaumstoffeinlage in Metallkasten.

Socket set

Chrome-Vanadium, chromium plated, with 2 components foam insert in metal case.

Dopsleutelset

Chroom-Vanadium, verchromd, met 2 componenten schuimleg in metalen koffer.

Composition de douilles

Chrome-Vanadium, chromées, avec plateau mousse bicolore, en coffret métallique.

Conjunto de llaves de vaso

Cromo Vanadio, cromadas, con material de espuma 2 compo-santes alta gama en caja metálica.



enthaltend/containing

	150 + 255 mm
	250 mm
	115 + 250 mm
	150 mm
	50 + 125 mm
	37 + 75 mm
	MM 16/20,8

		MM 4/4,5/5/5,5/6/7/8/9/10/11/12/13
		MM 14/15/16/17/18/19/20/21/22/23/24/27/30/32
	+	PH 1/2/3
	⬢	3/4/5/6
	⬢	4/5,5/7
	⬢	TT 8/10/15/20/25/27/30/40
	⬢	E 4/5/6/7/8/10

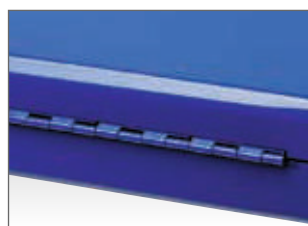

Bestell-No./Order-No.	Art. No.	Maße · Dimensions		
50883301683	50883-3016	430 x 250 x 65 mm	6000	1



Chrom-Vanadium, verchromt
 Chrome-Vanadium, chromium plated
 Chrom-Vanadium, verchromt
 Chrome-Vanadium, chromées
 Cromo Vanadio, cromadas

50825-5015

105-tlg./pcs./-dlg./pces./pzs.

Steckschlüsselgarnitur

Chrom-Vanadium, verchromt,
 in Kunststoffkoffer.

Socket set

Chrome-Vanadium, chromium plated,
 in plastic box.

Dopsleutelset

Chrom-Vanadium, verchromd,
 in kunststof koffer.

Composition de douilles

Chrome-Vanadium, chromées,
 en coffret plastique.

Conjunto de llaves de vaso

Cromo Vanadio, cromadas,
 en caja de plástico.



**HEYTEC
 BESTSELLER**



enthaltend/containing

	150 mm		250 mm
	50 / 100 mm		125 / 250 mm
	115 mm		3/8" 1/2"
	37 mm		75 mm
	150 mm		MM 10/11/12/13/ 14/15/16/17/18/ 19/20/21/22/23/ 24/27/30/32
	CL 25 mm MM 4/4,5/5/5,5/6/7/ 8/9/10/11/12/13/14		CL 40 mm
	CL 50 mm MM 6/7/8/9/10/ 11/12/13		CL 75 mm MM 14/15/17/19
			MM 16/20,8

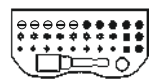

■ R1 - R2
 ● 3,5 - 8
 ● 2 - 8

⊕ PH1 - 3
 ⊕ PZ 1 - 3
 ⊕ TT 9 - 40

⊕ PZ 1 / PZ 2 ● 3/4/5/6 ● 4/5,5/7
 ⊕ PH 1 / PH 2 ⊕ TT 8/10/15/20/25/27/30

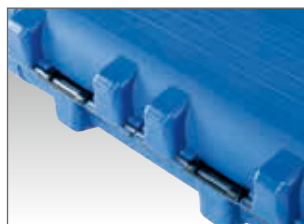

Bestell-No./Order-No.

Art. No.

Maße · Dimensions



50825501583

50825-5015

420 x 320 x 75 mm

6500

1

Schraubendreher-einsatz-Sortiment

Screwdriver socket set

Schroevendraaier dopsleutelset

Composition de douilles-tournevis

Surtido de llaves de vaso con destornillador

50850-53

33-tlg./pcs./dlg./pces./pzs.

Chrom-Vanadium, verchromt, in Kunststoffkoffer.

Chrome-Vanadium, chromium plated, in plastic box.

Chroom-Vanadium, verchromd, in kunststof koffer.

Chrome-Vanadium, chromées, en coffret plastique.

Cromo Vanadio, cromadas, en caja de plástico.



enthaltend/containing			
		62 mm	MM 5/6/7/8/10/12/14/17
		62 mm	TT 25/27/30/40/45/50/55/60
		62 mm	M 5/6/8/10
		100 mm	MM 6/8/10/12/14
		100 mm	T 30/40/50/60
		100 mm	M 6/8/10/12

← 62 mm →



← 100 mm →



Bestell-No./Order-No.	Art. No.	Maße · Dimensions		
* 50850530083	50850-53	350 x 280 x 80 mm	4400	1

* Auslauf / Discontinued

50850-54

28-tlg./pcs./dlg./pces./pzs.

Chrom-Vanadium, verchromt, für Schrauben mit Innen-RIBE und Vielzahn XZN-Köpfen, in Kunststoffkoffer.

Chrome-Vanadium, chromium plated, in plastic box, for fluted socket screws RIBE for multi-spline socket screws XZN.

Chroom-Vanadium, verchromd, voor schroeven met interne-RIBE en meertands XZN-koppen, in kunststof koffer.

Chrome-Vanadium, chromées, en coffret plastique, pour vis RIBE int. pour vis XZN int. multi-dents.

Cromo Vanadio, cromadas, en caja de plástico, para tornillos RIBE y XZN.



enthaltend/containing			
		62 mm	M 5/6/7/8/10/12/14
		62 mm	M 5/6/7/8/10/12/14
		138 mm	M 5/6/7/8/10/12/14
		138 mm	M 5/6/7/8/10/12/14

← 138 mm →

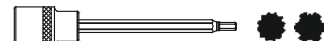

← 62 mm →

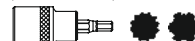

Bestell-No./Order-No.	Art. No.	Maße · Dimensions		
* 50850540083	50850-54	350 x 280 x 80 mm	4230	1

* Auslauf / Discontinued

50850-55

18-tlg./pcs./dlg./pces./pzs.

Chrom-Vanadium, verchromt, in Metallkasten.

Chrome-Vanadium, chromium plated, in metal case.

Chroom-Vanadium, verchromd, in metalen koffer.

Chrome-Vanadium, chromées, en coffret métallique.

Cromo Vanadio, cromadas, en caja metálica.



enthaltend/containing			
			62 mm T 20/25/27/30/40/45/50/55/60/70
			37 mm TT 8/10/15/20/25/27/30/40

Bestell-No./Order-No.	Art. No.	Maße · Dimensions		
50850550083	50850-55	220 x 120 x 40 mm	1500	1



Chrom-Vanadium, verchromt
 Chrome-Vanadium, chromium plated
 Chroom-Vanadium, verchromd
 Chrome-Vanadium, chromées
 Cromo Vanadio, cromadas

Schraubendreher-einsatz-Sortiment

Screwdriver socket set

Schroevendraaier
 doppleutelset

Composition de douilles-
 tournevis

Surtido de llaves de vaso
 con destornillador

50850-56

7-tlg./pcs./dlg./pces./pzs.

Chrom-Vanadium, verchromt,
 in Metallkasten.
 Chrome-Vanadium, chromium plated,
 in metal case.
 Chroom-Vanadium, verchromd,
 in metalen koffer.
 Chrome-Vanadium, chromées,
 en coffret métallique.
 Cromo Vanadio, cromadas,
 en caja metálica.



enthaltend/containing

62 mm 6/7/8/10/12/14/17



Bestell-No./Order-No.	Art. No.	Maße · Dimensions		
50850560283	50850-56	250 x 150 x 40 mm	1570	1

50850-58

14-tlg./pcs./dlg./pces./pzs.

Chrom-Vanadium, verchromt,
 in Metallkasten.
 Chrome-Vanadium, chromium plated,
 in metal case.
 Chroom-Vanadium, verchromd,
 in metalen koffer.
 Chrome-Vanadium, chromées,
 en coffret métallique.
 Cromo Vanadio, cromadas,
 en caja metálica.



enthaltend/containing

62 mm 4/5/6/7/8/10/12/14/17/19

36 mm 3/4/5/6

Bestell-No./Order-No.	Art. No.	Maße · Dimensions		
50850580083	50850-58	220 x 120 x 40 mm	1590	1

50850-59

9-tlg./pcs./dlg./pces./pzs.

Chrom-Vanadium, verchromt, in Metall-
 kasten, für Tamper-TORX®-Schrauben.
 Chrome-Vanadium, chromium plated,
 in metal case, for Tamper-TORX®-screws.
 Chroom-Vanadium, verchromd, in
 metalen koffer, voor inwendige TORX®
 schroeven met stift.
 Chrome-Vanadium, chromées, en coffret
 métallique, pour vis RESISTORX®.
 Cromo Vanadio, cromadas, en caja
 metálica. para tornillos Tamper TORX®.



enthaltend/containing

62 mm TT 20/25/27/30/40/
 45/50/55/60



Bestell-No./Order-No.	Art. No.	Maße · Dimensions		
* 50850590083	50850-59	250 x 150 x 40 mm	1650	1

* Auslauf / Discontinued

50850-55-12

20-tlg./pcs./-dlg./pces./pzs.

Schraubendreher-einsatz-Sortiment

Chrom-Vanadium, verchromt, für Innensechskantschrauben, in Kunststoffkoffer.

Screwdriver socket set

Chrome-Vanadium, chromium plated, in plastic box, for hexagon socket screws.

Schroevendraaier dopsleutelset

Chroom-Vanadium, verchromd, voor binnezesantbouten, in kunststof koffer.

Composition de douilles-tournevis

Chrome-Vanadium, chromées, en coffret plastique pour vis hexagonales int.

Surtido de llaves de vaso con destornillador

Cromo Vanadio, cromado, en caja de plástico para tornillos Allen.



enthaltend/containing

		62 mm	4/5/6/7/8/10/ 12/14/17/19
		138 mm	4/5/6/7/8/10/ 12/14/17/19

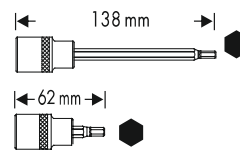

Bestell-No./Order-No.	Art. No.	Maße · Dimensions		
50850551283	50850-55-12	350 x 280 x 80 mm	3765	1

50851-3015

18-tlg./pcs./-dlg./pces./pzs.

Steckschlüsselgarnitur

Chrom-Vanadium, verchromt, in Kunststoffkoffer.

Socket set

Chrome-Vanadium, chromium plated, in plastic box.

Dopsleutelset

Chroom-Vanadium, verchromd, in kunststof koffer.

Composition de douilles

Chrome-Vanadium, chromées, en coffret plastique.

Conjunto de llaves de vaso

Cromo Vanadio, cromadas, en caja de plástico.



enthaltend/containing

	250 mm
	250 mm
	125 mm
	75 mm
	MM 10/11/12/13/14/ 15/17/19/21/24/27/30/32

Bestell-No./Order-No.	Art. No.	Maße · Dimensions		
50851301583	50851-3015	350 x 280 x 80 mm	3500	1

50860-3015

33-tlg./pcs./-dlg./pces./pzs.

Kombinierte Steckschlüssel- und Ringmaulschlüsselgarnitur

Chrom-Vanadium, verchromt, in Metallkasten.

Combined set of sockets and combination wrenches

Chrome-Vanadium, chromium plated, in metal case.

Gecombineerde dopsleutel- en ringsteeksleutelset

Chroom-Vanadium, verchromd, in metalen koffer.

Composition de douilles et clés mixtes

Chrome-Vanadium, chromées, en coffret métallique.

Juego combinados de llaves de vaso y llaves combinados

Cromo Vanadio, cromadas, en caja metálica.



enthaltend/containing

	250 mm
	250 mm
	125 mm
	70 mm
	MM 10/11/12/13/14/ 15/17/18/19/22/24/ 27/30/32
	MM 16/20,8
	MM 6/7/8/10/11/12/ 13/14/15/17/19/21/22

Bestell-No./Order-No.	Art. No.	Maße · Dimensions		
50860301580	50860-3015	450 x 187 x 52 mm	5600	1



Chrom-Vanadium, verchromt
 Chrome-Vanadium, chromium plated
 Chroom-Vanadium, verchromd
 Chrome-Vanadium, chromées
 Cromo Vanadio, cromadas



508100-00-6

DIN 3122 D · ISO 3315

Umschaltknarre

Mit Druckbetätigung zum Schnellösen und zur Arretierung der Steckverbindung, 72 Zähne.

Lever type reversible ratchet
 With quick release ejector button, 72 teeth.

Omschakelbare ratel
 Met ontgrendelstift, 72 tanden.

Cliquet réversible
 Tige d'éjection pour libérer rapidement l'outil du cliquet, 72 dents.

Carraca reversible
 Con expulsor para separación instantánea de vasos y accesorios, 72 dientes.



Bestell-No./Order-No.	Art. No.		mm	g	
50810000680	508100-00-6	3/4"	510	1700	2

508100-13

DIN 3122 C

Durchsteckknarre

Mit Verbindungsvierkant, 2-tlg.

Ratchet
 With square coupler, 2 pcs.

Doorsteekratel
 Met verbindingsvierkant, 2 dlg.

Cliquet
 Avec carré conducteur, 2 pcs.

Carraca
 Pasante de acoplamiento cuadrado 2 pzs.



Bestell-No./Order-No.	Art. No.		mm	g	
50810011380	508100-13	3/4"	472	1485	1

508100-03

DIN 3122 A · ISO 3315

Griff mit Gleitstück

Sliding Thandle

Greep met schuifstuk

Poignée coulissante

Mango corredizo



Bestell-No./Order-No.	Art. No.		mm	g	
50810003080	508100-03	3/4"	455	1360	2

508100-04/04-1/05
DIN 3123 B · ISO 3316

Verlängerungen
Extension bars
Verlengstukken
Rallonges
Alargaderas



508100-04-1



508100-04



508100-05

Bestell-No./Order-No.	Art. No.		\varnothing mm			
50810004180	508100-04-1	3/4"	100	440	2	
50810004080	508100-04	3/4"	200	840	2	
50810005080	508100-05	3/4"	400	1560	2	

508100-6
DIN 3124 / ISO 2725

Steckschlüsseleinsätze,
sechskant
Chrom-Vanadium, verchromt
Sockets, hexagon
Chrome-Vanadium, chromium plated
Dopsleutels, zeskant
Chroom-Vanadium, verchromd
Douilles, 6 pans
Chrome-Vanadium, chromées
Llaves de vaso, boca hexagonal
Cromo Vanadio, cromadas

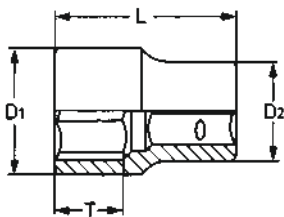

Bestell-No./Order-No.	\varnothing MM	\varnothing mm	T mm	D1 mm	D2 mm			
50810061980	19	50	15	29	33	168	5	
50810062180	21	50	15	31	33	172	5	
50810062280	22	50	15	33	36	211	5	
50810062380	23	50	15	33	36	211	5	
50810062480	24	50	15	34	36	225	5	
50810062680	26	52	26	37	36	223	5	
50810062780	27	52	26	38	36	224	5	
50810062980	29	52	26	40	38	262	5	
50810063080	30	54	26	42	38	285	5	
50810063280	32	56	28	44	38	305	5	
50810063480	34	56	26	47	36	390	5	
50810063580	35	58	30	48	42	395	5	
50810063680	36	58	30	50	42	434	5	
50810063880	38	60	30	52	45	472	5	
50810064180	41	64	36	56	45	550	5	
50810064680	46	68	36	62	48	685	5	
50810065080	50	72	40	68	48	800	5	
50810065580	55	76	38	74	45	860	5	
50810066080	60	78	42	80	45	1020	5	

50810-1401
DIN 3123 A · ISO 3316

Adapter
Converter
Adapter
Réducteur
Reductor



Bestell-No./Order-No.	Art. No.		\varnothing mm	\varnothing mm			
50810140180	50810-1401	1/2"	3/4"	50	206	10	



Chrom-Vanadium, verchromt
 Chrome-Vanadium, chromium plated
 Chrom-Vanadium, verchromd
 Chrome-Vanadium, chromées
 Cromo Vanadio, cromadas

508101-310

21-tlg./pcs./dlg./pces./pzs.

Steckschlüsselgarnitur

Chrom-Vanadium, verchromt,
 in Kunststoffkoffer.

Socket set

Chrome-Vanadium, chromium plated,
 in plastic box.

Dopsleutelset

Chroom-Vanadium, verchromd,
 in kunststof koffer.

Composition de douilles

Chrome-Vanadium, chromées,
 en coffret plastique.

Conjunto de llaves de vaso

Cromo Vanadio, cromadas,
 en caja de plástico.



enthaltend/containing



510 mm



MM 19/21/22/23/24/26/27/29/30/32/35/36/38/41/46/50



100 / 200 / 400 mm



455 mm

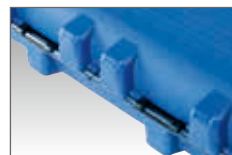

Bestell-No./Order-No.

Art. No.

Maße · Dimensions



50810131080

508101-310

580 x 400 x 90 mm

14000

1

IMPACT

Chrom Molybdän
 Chrome molybdenum
 Chrom molybdeen
 Chrome molybdène
 Cromo molibdeno

50863-3610

10-tlg./pcs./-dlg./pces./pzs.



**NEU
NEW**

1/2" IMPACT-Schraubendrehereinsatz-Sortiment

Chrom Molybdän, für Innen-TORX® Schrauben. Schaumstoffeinlage in Metallkasten.

1/2" IMPACT screw driver socket set

Chrome molybdenum, for TORX® head screws, with 2 components foam insert in metal case.

1/2" IMPACT krachttops-leutelset

Chroom molybdeen, voor binnen TORX® schroeven, met 2 componenten schuimleg in metalen koffer.

Assortiment de douilles de tournevis IMPACT 1/2"

Chrome molybdène, para tornillos TORX® internos, en cofre metálico.

Surtido de puntas de destornillador IMPACT de 1/2"

Cromo molibdeno, para vis TORX® interiores, con material de espuma 2 componentes alta gama en caja metálica.

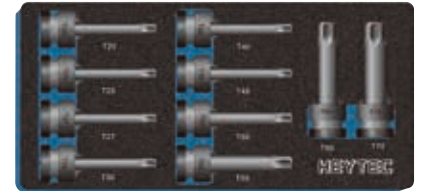

		enthaltend/containing									
		20	25	27	30	40	45	50	55	60	70
CL	mm	78	78	78	78	78	78	78	78	78	78
D ₁		3,9	4,45	5,1	5,5	6,6	7,75	8,9	11,15	13,15	15,35
D ₂		25	25	25	25	25	25	25	25	25	25

Bestell-No./Order-No.	Art. No.	Maße · Dimensions		
50863361036	50863-3610	270 x 135 x 40 mm	2000	1

50863-3110

10-tlg./pcs./-dlg./pces./pzs.



**NEU
NEW**

1/2" IMPACT-Schraubendrehereinsatz-Sortiment

Chrom Molybdän, für Innensechskant-Schrauben. Schaumstoffeinlage in Metallkasten.

1/2" IMPACT screw driver socket set

Chrome molybdenum, for hexagon socket screws, with 2 components foam insert in metal case.

1/2" IMPACT krachttops-leutelset

Chroom molybdeen, voor binnen-zeskantschroeven, met 2 componenten schuimleg in metalen koffer.

Assortiment de douilles de tournevis IMPACT 1/2"

Chrome molybdène, pour vis à six pans creux, en coffret métallique.

Surtido de puntas de destornillador IMPACT de 1/2"

Cromo molibdeno, para tornillos con hexágono interior, con material de espuma 2 componentes alta gama en caja metálica.

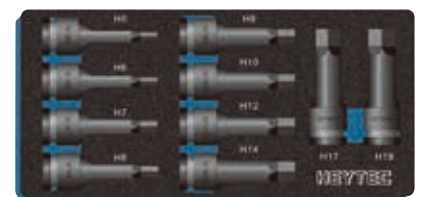

		enthaltend/containing									
		5	6	7	8	9	10	12	14	17	19
CL	mm	78	78	78	78	78	78	78	78	78	78
D ₁		5	6	7	8	9	10	12	14	17	19
D ₂		25	25	25	25	25	25	25	25	25	25

Bestell-No./Order-No.	Art. No.	Maße · Dimensions		
50863311036	50863-3110	270 x 135 x 40 mm	1920	1

IMPACT

Chrom Molybdän
 Chrome molybdenum
 Chromium molybdeen
 Chrome molybdène
 Cromo molibdeno

5086300

14-tlg./pcs./dlg./pces./pzs.

1/2" IMPACT-Steckschlüssel-einsatz-Sortiment

Chrom Molybdän, Schaumstoffeinlage in Metallkasten.

1/2" IMPACT socket set

Chrome molybdenum, with 2 components foam insert in metal case.

1/2" IMPACT krachtdops-leutelset

Chroom molybdeen, met 2 componenten schuiminleg in metalen koffer.

Assortiment de douilles IMPACT 1/2"

Chrome molybdène, en coffret métallique.

Surtido de puntas de destornillador IMPACT de 1/2"

Cromo molibdeno, con material de espuma 2 compo-santes alta gama en caja metálica.

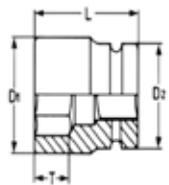

enthaltend/containing

SP 1/2"	10	12	13	14	15	16	17	18	19	21	22	23	24	27
CLD mm	38	38	38	38	38	38	38	38	38	38	38	38	38	38
D ₁	17	20	20,7	22	24	24	26	26,5	28	30	32	34	34	38
D ₂	24	24	24	24	24	24	26	26,5	28	30	32	34	34	38
T	14	14	14	14	14	14	14	14	20	20	20	20	20	20

Bestell-No./Order-No.

Art. No.

Maße · Dimensions



50863001436

5086300

315 x 150 x 42 mm

2150

1

**NEU
NEW**

5086300-19

14-tlg./pcs./dlg./pces./pzs.

1/2" IMPACT-Steckschlüssel-einsatz-Sortiment, extra lang

Chrom Molybdän, Schaumstoffeinlage in Metallkasten.

1/2" IMPACT socket set, extra deep

Chrome molybdenum, with 2 components foam insert in metal case.

1/2" IMPACT krachtdops-leutelset, extra lang

Chroom molybdeen, met 2 componenten schuiminleg in metalen koffer.

Assortiment de douilles IMPACT 1/2", extra-longues

Chrome molybdène, en coffret métallique.

Surtido de puntas de destornillador IMPACT extra largo de 1/2"

Cromo molibdeno, con material de espuma 2 compo-santes alta gama en caja metálica.

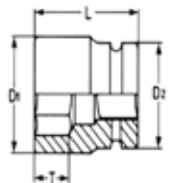

enthaltend/containing

SP 1/2"	10	12	13	14	15	16	17	18	19	21	22	23	24	27
CLD mm	78	78	78	78	78	78	78	78	78	78	78	78	78	78
D ₁	24	24	24	24	24	24	26	28	28	30	32	34	34	38
D ₂	24	24	24	24	24	24	26	28	28	30	30	30	30	30
T	27	27	27	37	37	37	37	37	37	37	37	37	37	37

Bestell-No./Order-No.

Art. No.

Maße · Dimensions



50863191436

5086300-19

380 x 170 x 55 mm

4000

1

**NEU
NEW**

IMPACT

Chrom Molybdän
 Chrome molybdenum
 Chromium molybdeen
 Chrome molybdène
 Cromo molibdeno

5086500

10-tlg./pcs./-dlg./pces./pzs.



**NEU
NEW**

3/4" IMPACT-Steckschlüssel-einsatz-Sortiment

Chrom Molybdän, Schaumstoffeinlage in Metallkasten.

3/4" IMPACT socket set

Chrome molybdenum, with 2 components foam insert in metal case.

3/4" IMPACT krachtdops-leutelset

Chroom molybdeen, met 2 componenten schuimleg in metalen koffer.

Assortiment de douilles IMPACT 3/4"

Chrome molybdène, en coffret métallique.

Surtido de puntas de destornillador IMPACT de 3/4"

Cromo molibdeno, con material de espuma 2 compo-santes alta gama en caja metálica.

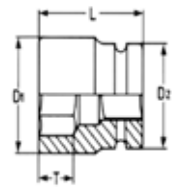

enthaltend/containing

SP 3/4"	24	27	30	32	33	34	36	38	41	46
CL mm	56	56	56	56	56	56	56	56	56	70
D ₁	38	41	46	48	50	50	52	54	58	63
D ₂	38	41	41	41	41	42	43	44	44	47
T	22	27	34	34	34	34	34	34	34	42

Bestell-No./Order-No.	Art. No.	Maße · Dimensions		
50865001036	5086500	370 x 170 x 85 mm	6500	1

5086500-19

10-tlg./pcs./-dlg./pces./pzs.



**NEU
NEW**

3/4" IMPACT-Steckschlüssel-einsatz-Sortiment, extra lang

Chrom Molybdän, Schaumstoffeinlage in Metallkasten.

3/4" IMPACT socket set, extra deep

Chrome molybdenum, with 2 components foam insert in metal case.

3/4" IMPACT krachtdops-leutelset, extra lang

Chroom molybdeen, met 2 componenten schuimleg in metalen koffer.

Assortiment de douilles IMPACT 3/4", extra-longues

Chrome molybdène, en coffret métallique.

Surtido de puntas de destornillador IMPACT extra largo de 3/4"

Cromo molibdeno, con material de espuma 2 compo-santes alta gama en caja metálica.

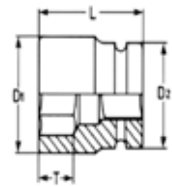

enthaltend/containing

SP 3/4"	24	27	30	32	33	34	36	38	41	46
CL mm	78	78	78	78	78	78	78	78	78	82
D ₁	38	41	46	48	50	50	52	54	58	63
D ₂	38	41	41	41	41	42	43	44	44	47
T	40	45	53	53	53	53	53	53	53	53

Bestell-No./Order-No.	Art. No.	Maße · Dimensions		
50865191036	5086500-19	370 x 170 x 85 mm	7900	1



3 KAPITEL CHAPTER

WERKSTATTWAGEN

Werkstattwagen
Module
Zubehör

CHARIOTS D'ATELIER

Servante d'atelier
Modules
Accessoires

WORKSHOP TROLLEYS

Workshop Trolleys
Modules
Accessories

CARROS DE TALLER

Carro de taller
Módulos
Accesorios

GEREEDSCHAPSWAGENS

Gereedschapswagens
Modules
Accessories

5081132

NEU
NEW

Werkstattwagen mit
7 Schubladen, leer

Hochwertiger Werkstattwagen in stabiler Metallkonstruktion, hochbelastbar und verwindungssteif. Der Werkstattwagen bietet durch seine 7 Schubfächer mit Kugelführung genügend Stauraum für Werkzeuge und Kleingeräte aller Art.

- Einzelauszugssperre

Workshop trolley with
7 drawers, empty

High-quality workshop trolley in stable metal construction, heavy-duty and torsion-resistant. Thanks to its 7 drawers with ball bearing runners, the workshop trolley offers sufficient storage space for tools and small equipment of all kinds.

- single pull-out stop

Gereedschapswagen met
7 laden, leeg

Hoogwaardige gereedschapswagen, stabiele metalen constructie, torsiebestendig en geschikt voor zware belasting. De gereedschapswagen biedt door de 7 laden met kogelgelagerde geleiderails genoeg opbergruimte voor gereedschappen en kleine apparaten.

- Uittrekbaarheid lade: Uittrekbeveiliging

Servante d'atelier à 7 tiroirs, vide

Chariot d'atelier de qualité supérieure de construction métallique stable, très résistant et indéformable. Grâce à ses 7 tiroirs avec guidage à billes, la servante d'atelier offre suffisamment d'espace de rangement pour les outils et les petits appareils de toutes sortes.

- Extraction tiroir: Sécurité antibasculement

Carro de taller con 7 cajones,
vacío

Carro de taller de alta calidad en construcción metálica estable, muy robusto y resistente a la torsión. Gracias a sus 7 cajones con guías de rodamiento de bolas, el carro de taller ofrece suficiente espacio de almacenamiento para herramientas y pequeños equipos de todo tipo.

- Extensión de cajones: Bloqueo de extensión

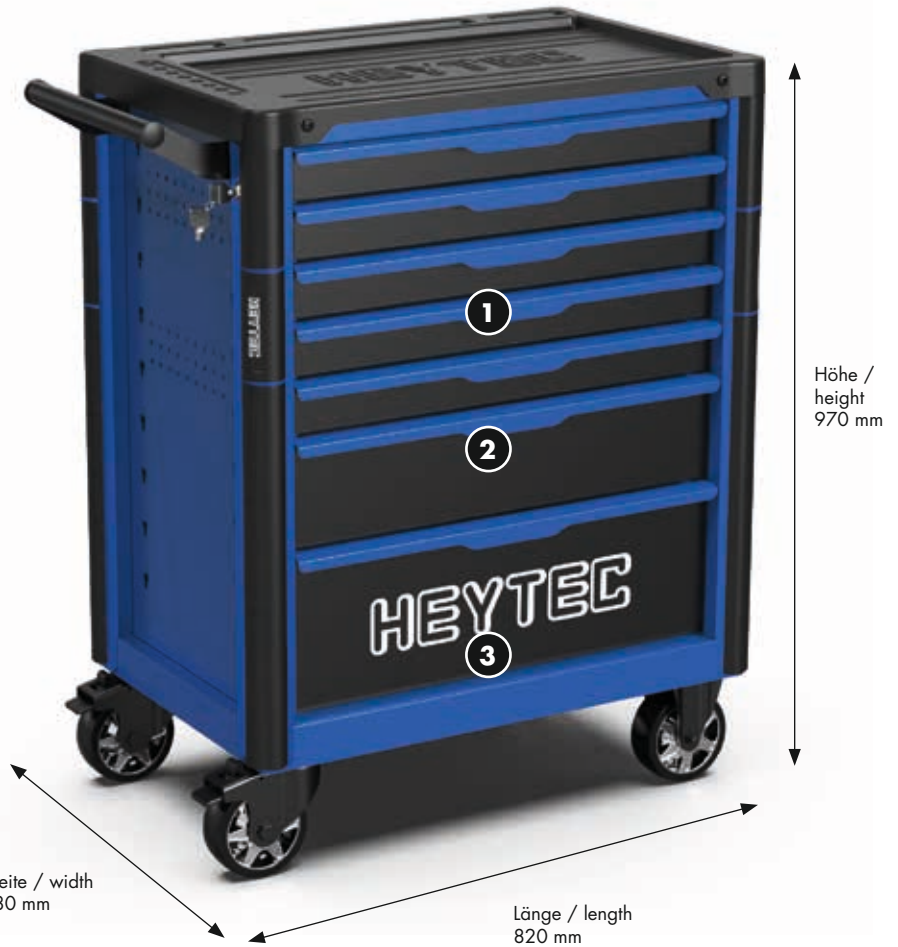

Abmessungen inkl. Räder und Griff
Dimensions incl. wheels and handle



7 Schubladen/Drawers

- ① 5 Schubladen 565 x 415 x 58 mm bel. 25 kg
- ② 1 Schublade 565 x 415 x 128 mm bel. 35 kg
- ③ 1 Schublade 565 x 415 x 195 mm bel. 50 kg

- Ablagefläche 620 x 360 mm
- work surface 620 x 360 mm

Zubehör/Accessories/
Toebehoren/Accessoires/Accessorios:
www.heyco-qualitaetswerkzeuge.de



Bestell-No./Order-No.	Art. No.	Maße · Dimensions		
50811320120	5081132	(L) 820 x (B) 480 x (H) 970 mm	63000	1

5081133

NEU
NEW

Werkstattwagen mit 6 Schubladen, leer

Hochwertiger Werkstattwagen in stabiler Metallkonstruktion, hochbelastbar und verwindungssteif. Der Werkstattwagen bietet durch seine 6 Schubfächer mit Kugelführung genügend Stauraum für Werkzeuge und Kleingeräte aller Art.

- Einzelauszugssperre
- Staufach mit 2 herausnehmbaren Regalfächer, abschließbar

Workshop trolley with 6 drawers, empty

High-quality workshop trolley in stable metal construction, heavy-duty and torsion-resistant. Thanks to its 6 drawers with ball bearing runners, the workshop trolley offers sufficient storage space for tools and small equipment of all kinds.

- single pull-out stop
- Storage compartment with 2 removable shelves, lockable

Gereedschapswagen met 6 laden, leeg

Hoogwaardige gereedschapswagen, stabiele metalen constructie, torsiebestendig en geschikt voor zware belasting. De gereedschapswagen biedt door de 6 laden met kogelgelagerde geleiderails genoeg opberg ruimte voor gereedschappen en kleine apparaten.

- Uittrekbaarheid lade: Uittrekbeveiliging
- Opbergvak met 2 verwijderbare planken, afsluitbaar

Servante d'atelier à 6 tiroirs, vide

Chariot d'atelier de qualité supérieure de construction métallique stable, très résistant et indéformable. Grâce à ses 6 tiroirs avec guidage à billes, la servante d'atelier offre suffisamment d'espace de rangement pour les outils et les petits appareils de toutes sortes.

- Extraction tiroir: Sécurité antibasculément
- Compartiment de rangement avec 2 étagères amovibles, verrouillables

Carro de taller con 6 cajones, vacío

Carro de taller de alta calidad en construcción metálica estable, muy robusto y resistente a la torsión. Gracias a sus 6 cajones con guías de rodamiento de bolas, el carro de taller ofrece suficiente espacio de almacenamiento para herramientas y pequeños equipos de todo tipo.

- Extensión de cajones: Bloqueo de extensión
- Compartimento de almacenamiento con 2 estantes extraíbles, con cerradura



Abmessungen inkl. Räder und Griff
Dimensions incl. wheels and handle

6 Schubladen/Drawers + 1 Ablagefach/storage compartment			
1	1 Schublade	932 x 415 x 77 mm	bel. 30 kg
2	2 Schubladen	565 x 415 x 58 mm	bel. 25 kg
3	2 Schubladen	565 x 415 x 128 mm	bel. 35 kg
4	1 Schublade	565 x 415 x 195 mm	bel. 50 kg
5	1 Staufach	315 x 430 x 700 mm	mit 2 herausnehmbaren Regalfächer
• Ablagefläche 1100 x 480 mm			
• work surface 1100 x 480 mm			

Zubehör/Accessories/
Toebehoren/Accessoires/Accessorios:
www.heyco-qualitaetswerkzeuge.de



Bestell-No./Order-No.	Art. No.	Maße · Dimensions		
50811330120	5081133	(L) 1190 x (B) 480 x (H) 1100 mm	113000	1

5081132-26

Werkstattwagen mit Modulen, 106-tlg.
Werkstattwagen Art. No. 5081132 mit 7 Schubladen.

Workshop trolley with modules, 106 pcs.
Workshop trolley Art. No. 5081132 with 7 drawers.

Gereedschapswagen met modules, 106-dlg.
Gereedschapswagen Art. No. 5081132 met 7 schuifladen.

Servante d'atelier avec modules, 106 pcs.
Servante d'atelier Art. No. 5081132 avec 7 tiroirs.

Carro de herramientas con módulos, 106 pzs.
Carro de herramientas Art. No. 5081132 con 7 cajones.

NEU
NEW



5089700-4



5089700-5



M 50829-50



M 50829-51

Details/Details /Details/Presentoirs/Expositores

59-66

Bestell-No./Order-No.	Art. No.	Module - Modules			
50811322600	5081132-26	M 50829-50 5089700-4 (2x)	M 50829-51 5089700-5 (2x)	72210	1

5081132-27

Werkstattwagen mit Modulen, 132-tlg.
Werkstattwagen Art. No. 5081132 mit 7 Schubladen.

Workshop trolley with modules, 132 pcs.
Workshop trolley Art. No. 5081132 with 7 drawers.

Gereedschapswagen met modules, 132-dlg.
Gereedschapswagen Art. No. 5081132 met 7 schuifladen.

Servante d'atelier avec modules, 132 pcs.
Servante d'atelier Art. No. 5081132 avec 7 tiroirs.

Carro de herramientas con módulos, 132 pzs.
Carro de herramientas Art. No. 5081132 con 7 cajones.

NEU
NEW



5089700-4



5089700-5



M 50829-50



M 50829-51



50829-54



M 50829-56

Details/Details /Details/Presentoirs/Expositores

59-66

Bestell-No./Order-No.	Art. No.	Module - Modules			
50811322700	5081132-27	M 50829-50 M 50829-54 5089700-4 (4x)	M 50829-51 M 50829-56 5089700-5 (4x)	78580	1

ZUBEHÖR	passend für Werkstattwagen	mit 7 Schubladen, Art. No. 5081132012	//	6 Schubladen, Art. No. 50811330120
ACCESSORIES	suitable for workshop trolley	with 7 drawers, Art. No. 50811320120	//	6 drawers, Art. No. 50811330120
ACCESSOIRES	geschikt voor werkplaatswagens	met 7 laden, Art. No. 50811320120	//	6 laden, Art. No. 50811330120
ACCESSOIRES	adaptés aux servantes d'atelier	à 7 tiroirs, Art. No. 50811320120	//	6 tiroirs, Art. No. 50811330120
ACCESORIOS	adecuados para carros de taller	con 7 cajones, Art. No. 50811320120	//	6 cajones, Art. No. 50811330120

911328-12

Papierkorb für Werkstattwagen

Bin for workshop trolley

Papiermand voor
gereedschapswagen

Poubelle pour servante d'atelier

Papelera para carros de taller

NEU
NEW



Bestell-No./Order-No.	Art. No.	Maße · Dimensions		
91132800120	911328-12	(L) 300 x (B) 190 x (H) 300 mm	2800	1

911328-22

Papierrollenhalter mit Ablage für Werkstattwagen

Paper roll holder with shel
for workshop trolley

Papierrolhouder met opberg-
vak voor gereedschapswagen

Porte-rouleau de papier avec
tablette pour servante d'atelier

Portarrollos de papel con
estante para carro de taller

NEU
NEW



Papierrolle nicht im
Lieferumfang enthalten.
Paper roll not included
in delivery.
Papierrol niet inbegrepen
in de levering.
Rouleau de papier non
compris dans la livraison.
Rollo de papel no
incluido en el suministro.

Bestell-No./Order-No.	Art. No.	Maße · Dimensions		
91132800220	911328-22	(L) 292 x (B) 300 x (H) 106 mm	1500	1

911328-32

Dokumentanablage für Werkstattwagen

Document holder
for workshop trolley

Dokumentenhouder
voor gereedschapswagen

Porte-documents pour
servante d'atelier

Portadocumentos para
carros de taller

NEU
NEW



Bestell-No./Order-No.	Art. No.	Maße · Dimensions		
91132800320	911328-32	(L) 250 x (B) 71 x (H) 265 mm	1800	1

911328-42

Dosenhalter für Werkstattwagen

Can holder
for workshop trolley

Bussen-/blikkenhouder
voor gereedschapswagen

Porte-boîtes pour
servante d'atelier

Soporte para latas para
carro de taller

NEU
NEW



Bestell-No./Order-No.	Art. No.	Maße · Dimensions		
91132800420	911328-42	(L) 250 x (B) 76 x (H) 108 mm	2300	1

1128-8-5

6-tlg./pcs./-dlg./pces./pzs.

Einlegetrennleisten

Separation profiles

Verdeelschotten

Sectionneurs

Listones separadores

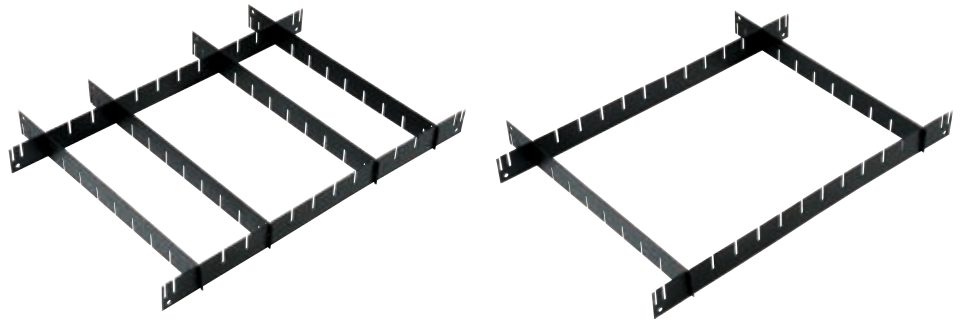

Bestell-No./Order-No.	Art. No.	Maße · Dimensions		
01128110200	1128-8-5	560 x 410 x 45 mm	1410	1

OPTIMAL EINGEPASST
OPTIMALLY FITTED
OPTIMAAL GEMONTEERD
PARFAITEMENT ADAPTÉ
ÓPTIMAMENTE AJUSTADO

Ausgleichsmodule zum Auffüllen der Schubladen in unseren neuen Werkstattwagen 5081132 und 5081133
Spacing module for filling the drawers in our new workshop trolley 5081132 and 5081133
Nivelleermodules voor het vullen van de laden in onze nieuwe werkplaatswagens 5081132 en 5081133
Modules de compensation pour remplir les tiroirs de nos nouvelles servantes d'atelier 5081132 et 5081133
Módulos de nivelación para llenar los cajones de nuestros nuevos carros de taller 5081132 y 5081133

5089700-5/5089700-4

Ausgleichsmodul

Zum Auffüllen der Schubladen, geeignet zum Lagern von Kleinteilen. Hochwertiger 2-K Schaumstoff.

Spacing module

For filling the drawers, suitable for storing small parts. High grade 2 components foam material.

Nivelleermodules

Voor het vullen van de laden, geschikt voor het opbergen van kleine onderdelen. Hoogwaardig 2 componenten schuimstof.

Module d'espacement

Pour remplir les tiroirs, adapté au stockage de petites pièces. Module mousse de haute qualité bicolore.

Módulo de espaciado

Para llenar los cajones, adecuado para almacenar piezas pequeñas. Plástico expandido de calidad 2-K.



5089700-4



5089700-5



Bestell-No./Order-No.	Art. No.	Maße · Dimensions		
50897000400	5089700-4	340 x 128 x 35 mm	60	1
50897000500	5089700-5	563 x 75 x 35 mm	60	1

5081129/5081130

Variable Bestückung der Schubladen mit Modulen

Variable assembly alternatives with modules

Variabele indeling van de schuifladen met modules

Equipement des tiroirs avec modules

Equipamiento de cajones con módulos

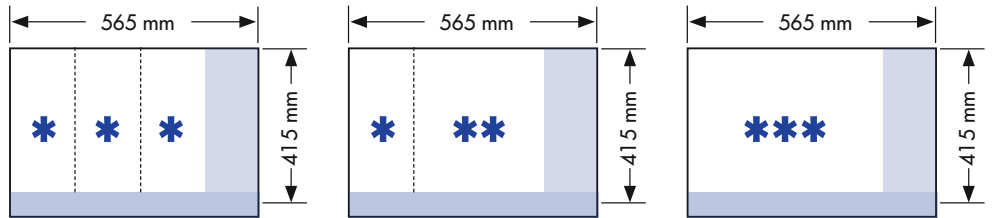

Hochwertiger 2-K Schaumstoff.
High grade 2 components foam material.
Hoogwaardig 2 componenten schuimstof.
Module mousse de haute qualité bicolore.
Plástico expandido de calidad 2-K.

Modul ** M 50829-4

17-tlg./pcs./dlg./pces./pzs.



Ringmaulschlüssel-Satz

Mit Schonprofil, Doppelmodul.

Combination wrenches set With SP-profile, double module.

Ringsteeksleutelset



Met profiel bescherming, dubbele module.

Jeu de clés mixtes

Avec profil de protection, module double.

Juego de llaves combinadas Con perfil especial SP, módulo doble.

enthaltend/containing	
	MM 6/7/8/9/10/11/ 12/13/14/15/16/ 17/18/19/20/21/22

Bestell-No./Order-No.	Art. No.	Maße · Dimensions		
50829000480	M 50829-4	340 x 290 x 40 mm	4400	1

Modul * M 50829-3

10-tlg./pcs./dlg./pces./pzs.



Doppelmaulschlüssel-Satz



Double open ended jaw wrenches set

Ringsleutelset

Jeu de clés à fourche

Juego de llaves fijas de boca abierta

enthaltend/containing	
	MM 8x9 / 10x11 / 12x13 / 14x15 / 16x17 / 18x19 / 20x22 / 21x23 / 24x27 / 30x32

Bestell-No./Order-No.	Art. No.	Maße · Dimensions		
50829000380	M 50829-3	340 x 145 x 40 mm	1832	1

Modul * M 50829-16

8-tlg./pcs./dlg./pces./pzs.



Doppelringschlüssel-Satz

Tief gekröpft, mit Schonprofil.

Double ended ring wrenches set

Deep offset, profile saver.

Ringsleutelset

Diep gebogen, met profiel bescherming.



Clés polygonales coudées

Avec profil de protection des têtes de vis.

Llaves boca estrella acodadas Codo profundo, dentado con perfil SP.

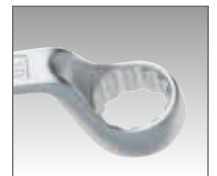
enthaltend/containing	
	MM 6x7 / 8x9 / 10x11 / 12x13 / 14x15 / 16x17 / 18x19 / 20x22



Bestell-No./Order-No.	Art. No.	Maße · Dimensions		
50829001680	M 50829-16	340 x 145 x 40 mm	1250	1

**Modul *
M 50829-2**

13-tlg./pcs./dlg./pces./pzs.

Knarren-Ringmaulschlüssel-Satz, umschaltbar

Combination ratchet wrenches set, reversible

Ringratelsleutelset, omschakelbaar

Jeu de clés mixtes à cliquet réversible

Juego de llaves combinadas con carraca reversible



enthaltend/containing

	MM 8/10/12/13/ 14/15/16/17/19/22
	1/4" / 3/8" / 1/2"

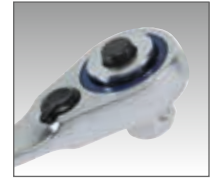
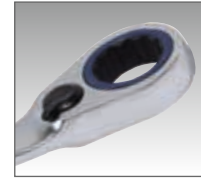

Bestell-No./Order-No.	Art. No.	Maße · Dimensions		
50829000280	M 50829-2	340 x 145 x 40 mm	1536	1

**Modul *
M 50829-9**

13-tlg./pcs./dlg./pces./pzs.

Knarren-Ringmaulschlüssel-Satz

Combination ratchet wrenches set

Ringratelsleutelset

Jeu de clés mixtes à cliquet

Juego de llaves combinadas con carraca



enthaltend/containing

	MM 8/9/10/12/13/ 14/15/16/17/19
	1/4" / 3/8" / 1/2"

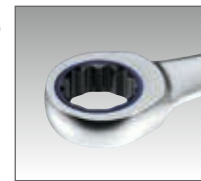

Bestell-No./Order-No.	Art. No.	Maße · Dimensions		
50829000980	M 50829-9	340 x 145 x 40 mm	1319	1

**Modul *
M 50829-13**

7-tlg./pcs./dlg./pces./pzs.

Betätigungswerkzeug-Satz

Accessories set

Hulpstukenset

Jeu d'accessoires

Juego de accesorios de accionamiento



enthaltend/containing

	250 mm
	250 mm
	125 mm
	75 mm
	MM 16/20,8

Bestell-No./Order-No.	Art. No.	Maße · Dimensions		
50829001383	M 50829-13	340 x 145 x 40 mm	1670	1

**Modul *
M 50829-12**

20-tlg./pcs./dlg./pces./pzs.

Steckschlüssel-Satz

Socket set

Dopsleutelset

Jeu de douilles

Juego de llaves de vaso



enthaltend/containing

	CL 40 mm	MM 10/11/12/13/ 14/15/16/17/ 18/ 19/20/21/22/24/ 27/30/32
	CL 75 mm	MM 13/17/19

Bestell-No./Order-No.	Art. No.	Maße · Dimensions		
50829001283	M 50829-12	340 x 145 x 40 mm	1974	1

**Modul *
M 50829-10**

IEC 60900
DIN 7437 · DIN 7438 PZ
6-tlg./pcs./-dlg./pces./pzs.

VDE-Schraubendreher-Satz

Mit umspritzter Klingen-isolierung
VDE-Screwdriver set
Insulation of blade and handle injection
moulded as one unit.

VDE schroevendraaierset

Met klingomspoten isolatie.
Jeu de tournevis VDE
Avec isolation de la lame par injection.
Juego de destornilladores VDE
Varillas con aislamiento inyectado.

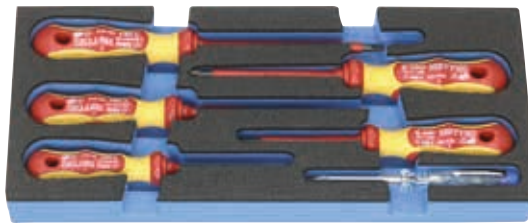

enthaltend/containing

	150 - 250 V
	MM 2,5x75 / 4x100 / 5,5x125
	PZ 1 / PZ 2

mit 2K-Griff
with 2 components plastic handles
met 2 componenten greep
avec poignée à 2 composantes
con mango de dos componentes

Bestell-No./Order-No.	Art. No.	Maße · Dimensions		
50829001033	M 50829-10	340 x 145 x 40 mm	583	1

**Modul *
M 50829-14**

36-tlg./pcs./-dlg./pces./pzs.

Steckschlüssel-Satz

Socket set
Dopsleutelset
Jeu de douilles
Juego de llaves de vaso



enthaltend/containing

	150 mm
	150 mm
	50 + 100 mm
	37 mm
	CL 25 mm MM 4/4,5/5/6/7/ 8/ 9/10/11/12/13
	CL 50 mm MM 6/7/8/9/10/ 11/12/13
	PZ 1 / PZ 2
	3/4/5/6
	0,8x4 / 1x5,5
	TT15 / TT20 / TT25 / TT30

Bestell-No./Order-No.	Art. No.	Maße · Dimensions		
50829001483	M 50829-14	340 x 145 x 40 mm	1025	1

**Modul *
M 50829-17**

24-tlg./pcs./-dlg./pces./pzs.

**Schraubendrehereinsatz-
Sortiment**

Screwdriver socket set
Schroevendraaijer dopsleutelset
Composition de douilles-
tournevis
Conjunto de llaves de vaso
con destornillador



enthaltend/containing

	CL 62 mm	5/6/7/8/10/12/14/17
	CL 62 mm	T 25/27/30/40/45/50/55/60
	CL 100 mm	6/8/10/12
	CL 100 mm	T 30/40/50/60

Bestell-No./Order-No.	Art. No.	Maße · Dimensions		
50829001783	M 50829-17	340 x 145 x 40 mm	2525	1

**Modul *
M 50829-5**

3-tlg./pcs./-dlg./pces./pzs.

**Zangenmodul mit
Schlosserhammer**

Pliers and hammer set
Tangenmodule met bankhamer
Pince multiprise et pince-étou
Juego de 3 pzs.



enthaltend/containing

	300 g
	250 mm
	235 mm

Bestell-No./Order-No.	Art. No.	Maße · Dimensions		
50829000500	M 50829-5	340 x 145 x 40 mm	1325	1

Modul * M 50829-11

5-tlg./pcs./-dlg./pces./pzs.



Radwechsel-Satz

Bestehend aus 3 Impact-Einsätzen mit Kugelfangbohrung, inkl. Kunststoffhülsen zum Schutz von Alufelgen, Kunststoffschaber.

Tools for wheel changing set
Consisting of 3 impact sockets with ball retaining groove, including plastic sleeves for protecting alloy rims, plastic scraper.

Wielmoersleutelset

Bestaande uit 3 krachttoppen met kogelvangsleuf, incl. kunststof hulzen, ter bescherming van aluminium velgen, kunststof schraper.

Jeu pour écrous de roues
Composé de 3 douilles impact avec trou pour bille et manchon plastique de protection des jantes en aluminium, racloir en plastique.

Juego de herramientas para cambio de ruedas

Con 3 llaves de vaso de impacto con agujero para fijación, incluidos protectores de plástico para no dañar llantas de aluminio, rascador de plástico.



enthaltend/containing	
	CL 85 mm MM 17/19/21
	280 mm
	285 mm

Bestell-No./Order-No.	Art. No.	Maße · Dimensions		
50829001100	M 50829-11	340 x 145 x 40 mm	842	1

Modul * M 50829-15

3-tlg./pcs./-dlg./pces./pzs.

Zangen-Satz

Kombinationszange, gerade Flachrundzange, Seitenschneider schwedische Form, mit Kunststoffhandschutz.

Pliers set

Combination plier, snipe nose plier, diagonal cutting nipper, with plastic handle.

Zangenset

Combinatietang, telefoontang recht, zijsnijtang zweeds model, met kunststof greep.

Jeu de pinces

Pince universelle, pince à becs demi-ronds, droite, pince coupante diagonale modèle suédois, avec gaine plastique.

Conjunto de 3 alicates

Alicate universal alicate de radio recto cortalambres modelo sueco, con fundas de plástico.



enthaltend/containing	
	180 mm
	200 mm
	160 mm

Bestell-No./Order-No.	Art. No.	Maße · Dimensions		
50829001542	M 50829-15	340 x 145 x 40 mm	715	1

Modul * M 50829-8

6-tlg./pcs./-dlg./pces./pzs.



Schraubendreher-Satz mit 2K-Griff

Screwdriver set

Schroevendraaierset met 2 componenten greep

Jeu de tournevis avec poignée bimatière

Juego de destornilladores con mango de dos componentes



enthaltend/containing	
	150 - 250 V
	MM 4x75 5,5x125 6,5x150
	PH 1 / PH 2

Bestell-No./Order-No.	Art. No.	Maße · Dimensions		
50829000880	M 50829-8	340 x 145 x 40 mm	553	1

Modul *
M 50829-19

IEC 900/DIN EN 60900
3-tlg./pcs./-dlg./pces./pzs.



VDE-Zangen-Satz

Köpfe geschliffen und lackiert, Griffe mit 2-K Isoliergriffen. Schneide für mittelharten Draht.

VDE Pliers set

Heads ground and lacquered with 2 K insulated handle, cutting edges for middlehard wire.

VDE tangenset

Kop gepolijst en gelakt, grepen met 2 componenten isolatiegreep, knipt middelharde draad.

Jeu de pinces VDE

Chromées et laquées, poignées gainées isolées bimatière, pour fil de dureté moyenne.

Conjunto de 3 alicates, VDE

Cabeza amolada y barnizada, mangos con fundas aislantes 2K, cortante para alambre semi-duro.

enthaltend/containing	
	180 mm
	200 mm
	160 mm

Bestell-No./Order-No.	Art. No.	Maße · Dimensions		
50829001986	M 50829-19	340 x 145 x 40 mm	710	1

Modul ***
M 50829-18

IEC 60900,
DIN 7437/DIN 7438 PZ
12-tlg./pcs./-dlg./pces./pzs.

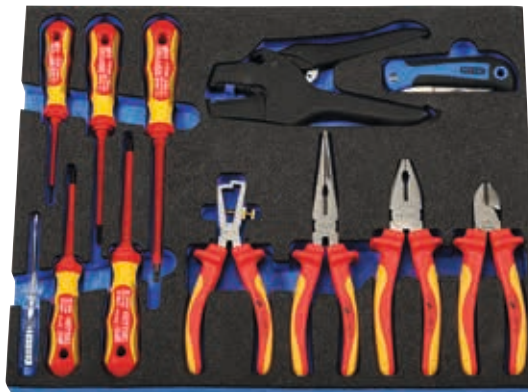

VDE-Werkzeugsortiment

In 2-K Schaumstoffeinlage.

VDE Tool set

With 2 components foam insert.

VDE schroevendraaierset

Met 2 componenten greep.

Sélection d'outillage VDE

Sur plateau mousse bicolore.

Conjunto de herramientas VDE

Con material de espuma 2 componentes alta gama.

enthaltend/containing	
	180 mm
	160 mm
	200 mm
	160 mm
	200 mm
	115 - 195 mm
	150 - 250 V
	MM 0,4 x 2,5 x 75 / 0,8 x 4,0 x 100 / 1,0 x 5,5 x 125
	PZ 1 / PZ 2

mit 2K-Griff
with 2 components plastic handles

Bestell-No./Order-No.	Art. No.	Maße · Dimensions		
50829001800	M 50829-18	435 x 340 x 35 mm	2910	1

Modul ***
M 50829-50

36-tlg./pcs./-dlg./pces./pzs.

Schlüssel-Satz

Mit Schonprofil, Doppelmodul.

Combined wrenches set

With SP-profile, double modul.

Leutelset

Met profiel bescherming, dubbele module.

Jeu de clés mixtes

Avec profil de protection, module double.

Juego de llaves combinadas

Con perfil especial SP, módulo doble.



enthaltend/containing	
	MM 6/7/8/9/10/11/12/13/14/15/16/17/18/19/20/21/22/24
	MM 6x7/ 8x9 / 10x11 / 12x13 / 14x15 / 16x17 / 18x19 / 20x22
	MM 6x7 / 8x9 / 10x11 / 12x13 / 14x15 / 16x17 / 18x19 / 20x22 / 24x27
	205 mm / 0 - 30 mm

Bestell-No./Order-No.	Art. No.	Maße · Dimensions		
50829005000	M 50829-50	435 x 340 x 35 mm	4500	1

Modul *
M 50829-51**

70-tlg./pcs./dlg./pces./pzs.

Kombinierter Steckschlüssel-Satz

Combined socket set
Gecombineerde Dopsleutelset
Composition de douilles
Conjunto de llaves de vaso



enthaltend/containing	
	150 + 250 mm
	150 mm
	37 + 75 mm
	250 mm
	50 + 100 + 125 mm
CL 25 mm	MM 4/4,5/5/5,5/6/7/8/9/10/11/12/13
CL 50 mm	MM 6/7/8/9/10/11/12/13
CL 40 mm	MM 10/11/12/13/14/15/16/17/18/19/20/21/22/24/27/30/32
CL 75 mm	MM 10/13/14/15/17/19/22
CL 65 mm	MM 16/20,8
PZ 1 / PZ 2 3/4/5/6	0,8x4 / 1x5,5
	TT 10/15/20/25/27/30/40

Bestell-No./Order-No.	Art. No.	Maße · Dimensions		
50829005100	M 50829-51	435 x 340 x 35 mm	4710	1

Modul *
M 50829-52**

48-tlg./pcs./dlg./pces./pzs.

Schraubendrehereinsatz Sortiment

Screwdriver socket set
Schroevendraaier dopsleutelset
Composition de douilles-tournevis
Conjunto de llaves de vaso con destornillador

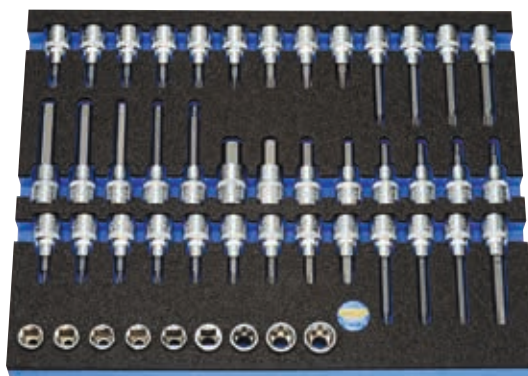

enthaltend/containing	
CL 62 mm	5/6/7/8/10/12/14/17
CL 100 mm	6/8/10/12/14
CL 62 mm	M5 / M6 / M8 / M10
CL 62 mm	T 20/25/27/30/40/45/50/55/60
CL 100 mm	M 6/8/10/12
CL 100 mm	T 30/40/50/60
CL 38 mm	E 10/11/12/14/16/18/20/22/24
CL 62 mm	M5 / M6 / M8 / M10 / M12

Bestell-No./Order-No.	Art. No.	Maße · Dimensions		
50829005200	M 50829-52	435 x 340 x 35 mm	4630	1

Modul *
M 50829-53**

17-tlg./pcs./dlg./pces./pzs.

Steckschlüssel-Satz

Socket set
Dopsleutelset
Jeu de douilles
Juego de llaves de vaso



enthaltend/containing	
	510 mm
	455 mm
	3/4" - 1/2"
	100 + 200 + 400 mm
CL 40 mm	MM 19/22/24/27/30/32/36
	HW 14/17/19/22

Bestell-No./Order-No.	Art. No.	Maße · Dimensions		
50829005300	M 50829-53	435 x 340 x 35 mm	8800	1

Modul ***
M 50829-54

10-tlg./pcs./dlg./pces./pzs.

Zangen-Satz

Pliers set

Zangenset

Jeu de pinces

Conjunto de 10 alicates



enthaltend/containing	
	250 mm
	230 mm
	260 mm
	235 mm
	200 mm
	180 mm
	200 mm
	160 mm
	Gr. 18 mm inkl. Ersatzklingen / incl. Spare blades

Bestell-No./Order-No.	Art. No.	Maße · Dimensions		
50829005400	M 50829-54	435 x 340 x 35 mm	2870	1

Modul ***
M 50829-55

35-tlg./pcs./dlg./pces./pzs.

Schraubendreher-Satz mit 2K-Griff

Screwdriver set

Schroevendraaierset met

2 componenten greep

Jeu de tournevis avec poignée à 2 composantes

Juego de destornilladores con mango de dos componentes



enthaltend/containing	
	150 - 250 V
	MM 4x75 / 5,5x125 / 6,5x150
	PH 1 / PH 2
	T 15/20/25/27/30/40
	MM 8/6/5/4/3
	T 10/15/20/25/27/30/40/45/50
	MM 1,5/2/2,5/3/4/5/6/8/10

Bestell-No./Order-No.	Art. No.	Maße · Dimensions		
50829005500	M 50829-55	435 x 340 x 35 mm	1800	1

Modul ***
M 50829-56

16-tlg./pcs./dlg./pces./pzs.

Kombinierter Werkzeug-Satz

Combination tool set

Gecombineerde gereedschapset

Ensemble d'outils combinés

Set de herramientas combinadas



enthaltend/containing	
	1000 g
	300 g
	Ø 35
	200 mm
	Ø 3 x 120 mm
	Ø 5 x 150 mm
	Ø 3 x 120 mm
	5 x 130 mm
	12 x 130 mm
	14 x 150 mm

Bestell-No./Order-No.	Art. No.	Maße · Dimensions		
50829005600	M 50829-56	435 x 340 x 35 mm	3500	1

Modul ***
M 50829-57

17-tlg./pcs./dlg./pces./pzs.

Werkzeug-Satz „KFZ“

Vehicle tool set

Gereedschapset "KFZ",

Composition automobile

Conjunto de herramientas "KFZ"



enthaltend/containing	
	CL 85 mm MM 17/19/21
	CL 150 mm MM 17/19/21
	280 mm
	400 mm
	290 mm
	260 mm
	CL 75 mm MM 16/20,8
	84 mm
	0-60 mm
	40 - 200 Nm

Bestell-No./Order-No.	Art. No.	Maße · Dimensions		
50829005700	M 50829-57	435 x 340 x 35 mm	4200	1



4 KAPITEL CHAPTER

WERKZEUGSORTIMENTE

L-BOXX®
Metallkästen
Koffer
Taschen
Rucksäcke
Module / Ordnungssysteme

ASSORTIMENTS D'OUTILS

L-BOXX®
Boîte métallique
Valise à outils
Sacs à bandoulière
Sacs à dos
Systèmes de rangement

TOOL ASSORTMENTS

L-BOXX®
Metal cases
Plastic box
Bag
Backpacks
Modules / Ordering systems

SURTIDOS DE HERRAMIENTAS

L-BOXX®
Cajas metálicas
Cajas
Bolsas
Mochilas
Módulos / sistemas de organización

GEREEDSCHAPSETS

L-BOXX®
Gereedschapskist
Gereedschapskoffer
Gereedschapstas
Rugzakken
Modules/ Organisatiesystemen

508076-945

96-tlg./pcs./-dlg./pces./pzs.

Montage-Werkzeugkasten mit 5 Modulen

Tool box, cantilever type with 5 modules

Gereedschapskist met 5 modules

Boîte à outils avec 5 modules

Caja de herramientas con 5 módulos

**HEYTEC
BESTSELLER**



enthaltend/containing

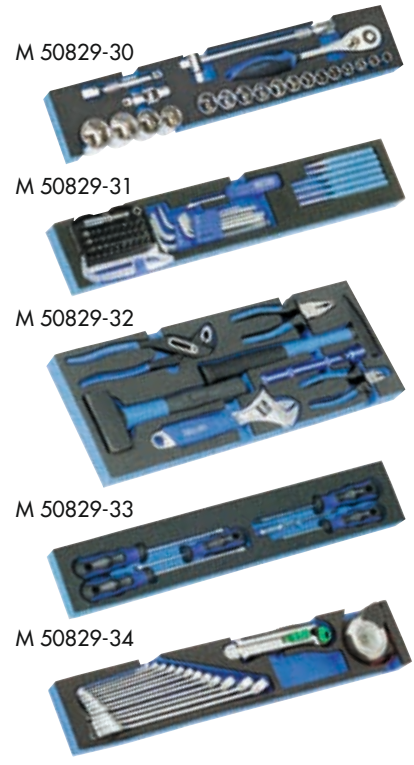

Bestell-No./Order-No.	Art. No.	Module - Modules				
50807694500	508076-945	M 50829-30	M 50829-31	M 50829-32	14430	1
		M 50829-33	M 50829-34			

M 50829-30

21-tlg./pcs./-dlg./pces./pzs.

Werkzeugmodul

Tool module

Gereedschapsmodule

Module avec outils

Módulo con herramientas

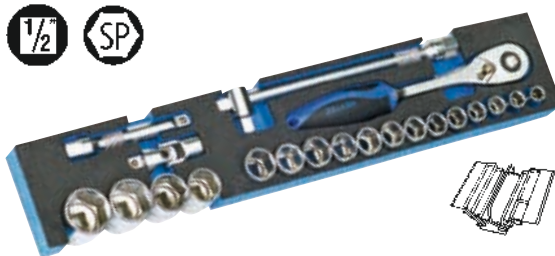

enthaltend/containing



Bestell-No./Order-No.	Art. No.	Module - Modules		
50829003083	M 50829-30	528 x 98 x 35 mm	2954	1

M 50829-31

48-tlg./pcs./-dlg./pces./pzs.

Werkzeugmodul

Tool module

Gereedschapsmodule

Module avec outils

Módulo con herramientas

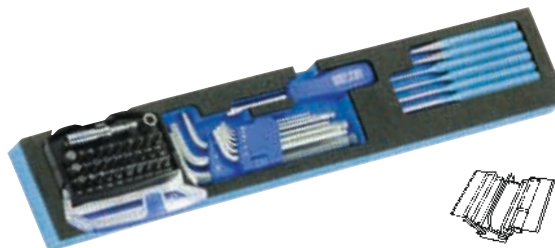

enthaltend/containing



Bestell-No./Order-No.	Art. No.	Module - Modules		
50829003100	M 50829-31	528 x 98 x 35 mm	1063	1

M 50829-32

7-tlg./pcs./dlg./pces./pzs.

Werkzeugmodul

Tool module

Gereedschapsmodul

Module avec outils

Módulo con herramientas

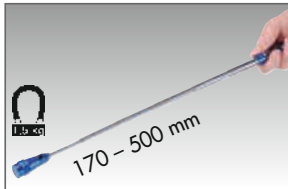

enthaltend/containing	
	1000 g
	300 g
	170 - 500 mm
	180 mm
	250 mm
	160 mm
	255 mm

Bestell-No./Order-No.	Art. No.	Module - Modules		
50829003200	M 50829-32	528 x 195 x 35 mm	3040	1

M 50829-33

6-tlg./pcs./dlg./pces./pzs.

Werkzeugmodul

Tool module

Gereedschapsmodul

Module avec outils

Módulo con herramientas

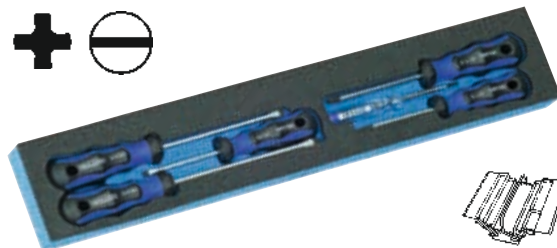

enthaltend/containing	
	0,75 x 3,0 x 60 mm
	4,0 x 75 mm
	5,5 x 125 mm
	6,5 x 150 mm
	PH 1 / PH 2

Bestell-No./Order-No.	Art. No.	Module - Modules		
50829003380	M 50829-33	528 x 98 x 35 mm	483	1

M 50829-34

14-tlg./pcs./dlg./pces./pzs.

Werkzeugmodul

Tool module

Gereedschapsmodul

Module avec outils

Módulo con herramientas

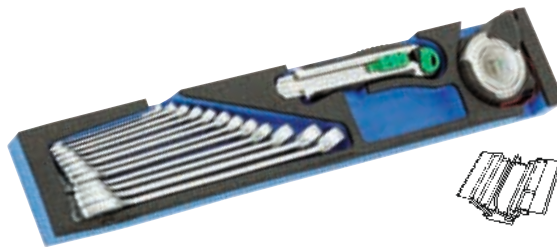

enthaltend/containing	
	MM 8/10/11/12/ 13/14/15/16/17/ 19/22/24
	170 mm
	5 m

Bestell-No./Order-No.	Art. No.	Module - Modules		
50829003480	M 50829-34	528 x 98 x 35 mm	1888	1

M 50829-35

16-tlg./pcs./dlg./pces./pzs.

Austauschmodul für Montage-Werkzeugkasten

Exchange modul
for tool box set

Extra module voor
mantage gereedschapskist

Module alternatif pour
boîte à outils pour monteurs

Módulo intercambiable
para caja de herramientas

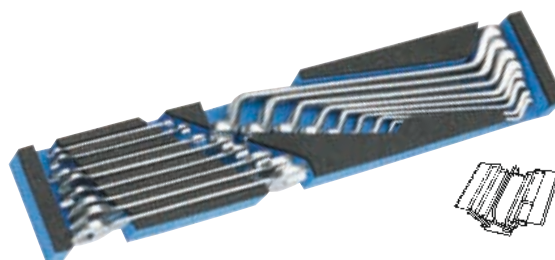

enthaltend/containing	
	MM 6x7/8x9/10x11/ 12x13/14x15/16x17/ 18x19/20x22
	MM 6x7/8x9/10x11/ 12x13/14x15/16x17/ 18x19/20x22

Bestell-No./Order-No.	Art. No.	Module - Modules		
50829003580	M 50829-35	528 x 98 x 35 mm	1960	1

98076-08

5-tlg./pcs./-dlg./pces./pzs.

Montage-Werkzeugkasten, leer

Stahlblech, in Hammerschlagblau.

Tool box, cantilever type,
empty



Sheet steel, hammertone blue.

Gereedschapskist, leeg
Plaatstaal, in blauw hamerslag lak.

Boîte à outils, vide
En tôle d'acier couleur bleu martelé.

Caja de herramientas, vacío
En chapa de acero, pintada en azul.



Bestell-No./Order-No.	Art. No.	Maße · Dimensions		
98076080020	98076-08	530 x 200 x 200 mm	3250	1

50881-6

28-tlg./pcs./-dlg./pces./pzs.

Werkzeugkasten „JUNIOR“

Mit Sortiment, 28-tlg.
Stahlblech, lackiert.

Tool box „JUNIOR“
With 28 pcs. assortment
sheet steel, lacquered.



Gereedschapskist „JUNIOR“
Met assortiment, 28-delig.
Plaatstaal, gelakt.

Boîte à outils „JUNIOR“
Avec assortiment d'outils 28 pces.
en tôle d'acier, peint.

Caja herramientas „JUNIOR“
Con surtido de 28 pzs.
en chapa de acero lacado.



enthaltend/containing			
	MM 6x7 / 8x9 / 10x11 / 12x13 / 14x15 / 16x17 / 18x19 / 20x22		500 g
	MM 4,0 x 75 5,5 x 125 / 6,5 x 150		MM 1,5/2/2,5/3/ 4/5/6/8/10
	PH 1 / 2		TX 10/15/20/25/ 27/30/40/45/50
	150 - 250 V		155 mm / 6" Nonius 1/20 mm / 1/128"
	160 mm		Gr. 18 mm
	230 mm		3 m
	250 mm		230 mm
	200 mm		
	200 mm		CE/EN 388-4131

Bestell-No./Order-No.	Art. No.	Maße · Dimensions		
50881000600	50881-6	430 x 185 x 200 mm	8400	1

508201-762

97-tlg./pcs./dlg./pces./pzs.

Montage-Werkzeugsortiment

L-BOXX® Module mit 97 Werkzeugen. Beladungskapazität pro Box bis zu 25 kg. Transport der Boxen im Verbund bis 40 kg.

Construction tool set L-BOXX® Modules with 97 tools. Loading capacity of up to 25 kg. Transported in bundles up to 40 kg.

Montage gereedschapset L-BOXX® modulemet 97 stuks gereedschap. Koffer belastbaar tot 25 kg. Bij gekoppelde koffers belastbaar tot 40 kg.

Assortiment d'outils d'assemblage

Module L-BOXX® avec 97 outils. Capacité de chargement par boîte jusqu'à 25 kg. Transport des boîtes en cumulé jusqu'à 40 kg.

Conjunto de herramientas de montaje

L-BOXX® Módulos con 97 herramientas. Capacidad de carga por conjunto hasta 25 kgs. Transporte de las cajas en conjunto hasta 40 kgs.



Einfache Klickverbindung. Einzigartiges Mobilitätssystem. Beliebiger Erweiterbar. Aus schlag- und stoßfestem ABS-Kunststoff. Ergonomisch geformten Griffe, zusätzliche seitliche Griffschalen sowie praktische Schlaufen garantieren ein flexibles und komfortables Handling. Der Deckel ist bis 100 kg belastbar, spritzwassergeschützt.

Robust click mechanism. Expandable as desired. Unique mobility system. Made of impact and shock resistant ABS plastic. Ergonomically shaped handles and additional side grips for flexible and convenient handling. The lid can hold a load of up to 100 kg, spray-water protected.

Bestell-No./Order-No.	Art. No.	Maße - Dimensions	Module - Modules		
50820176200	508201-762	442 x 357 x 151 mm	50807696100 50807696200	11690	1

50876-961

77-tlg./pcs./dlg./pces./pzs.

Montage-Werkzeugsortiment für L-BOXX®

Construction tool set for L-BOXX®

Montage gereedschapset voor L-BOXX®

Assortiment d'outils de montage pour L-BOXX®

Caja herramientas para L-BOXX®



enthaltend/containing

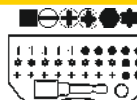

50833-2
siehe Seite 111/see page 111

- 255 mm
- 250 mm 125 mm
- 250 mm
- 75 mm
- MM 1,5/2/2,5/3/4/5/6/8/10
- 200 mm 230 mm
- MM 8/10/11/12/13/14/15/16/17/19/22/24
- MM 10/11/12/13/14/15/16/17/18/19/20/21/22/24/27/30/32

Bestell-No./Order-No.	Art. No.	Maße - Dimensions		
50807696100	50876-961	405 x 310 x 50 mm	5910	1

50876-962

20-tlg./pcs./dlg./pces./pzs.

Montage-Werkzeugsortiment für L-BOXX®

Construction tool set for L-BOXX®

Montage gereedschapset voor L-BOXX®

Assortiment d'outils de montage pour L-BOXX®

Caja herramientas para L-BOXX®



enthaltend/containing

- 150 - 250 V
- 0,8 x 4,0 x 75 mm / 1,0 x 5,5 x 125 mm / 1,2 x 6,5 x 150 mm
- PH 1 / PH 2
- 3 m Gr. 18 mm
- 1000 g 300 g
- 250 mm
- 180 mm 160 mm
- 170 - 500 mm

- Ø 3 x 120 mm
- Ø 3 x 150 mm
- Ø 4 x 150 mm
- Ø 5 x 150 mm
- Ø 6 x 150 mm
- Ø 4 x 120 mm

Bestell-No./Order-No.	Art. No.	Maße - Dimensions		
50807696200	50876-962	405 x 310 x 40 mm	5110	1

508675

134-tlg./pcs./dlg./pces./pzs.



Montage-Werkzeugkoffer

Mit 4 Modulen.

Hochwertiger ABS-Schalenkoffer mit Werkzeugtafeln und 2-K Schaumstoffeinlage.

Ausstattungsmerkmale:

- Schlagfestes ABS-Material
- Umlaufender Stoßkantenschutz
- Hochwertige Metallschlösser
- Stabiler und gehärteter Aluminiumrahmen
- Ergonomischer Tragegriff
- Drei Metallscharniere
- Stabiler Deckelhalter

Construction tool case

With 4 modules.

Premium-quality ABS-Shell case with tool- and 2-K foam inlays.

Features:

- Impact-proof ABS-material
- Circumferential abutting edge-protection
- Premium-quality metal locks
- Stable and hardened aluminium frame
- Ergonomic carrying handle
- Three metal hinges
- Stable lid holder



Montage gereedschapskoffer

Met 4 modules.

Hoogwaardige ABS koffer met gereedschapbladenen 2 componenten schuimstofinleg.

Uitgerust met:

- Slagvast ABS
- rondom uitgevoerd met beschermrand
- hoogwaardige metalen sloten
- robuust en gehard aluminium frame
- ergonomische greep
- drie metalen scharnieren
- robuuste dekselscharnieren

Valise à outils

Avec 4 modules.

Boîtier ABS de haute qualité avec plateau d'outils et deux inserts en mousse 2 composants.

Caractéristiques:

- Matériel ABS autour de la valise
- Pare-chocs autour du coffret
- Serrures métalliques de haute qualité
- Cadre en aluminium stable et dur
- Poignée ergonomique
- Trois charnières métalliques
- Support à couvercle robuste



Cofre de herramientas para montadores

Con 4 módulos.

Maleta de plástico ABS con bandejas de herramientas y forro de dos componentes.

Características del equipamiento:

- Plástico tipo ABS- cantos protegidos
- Umlaufender Stoßkantenschutz
- Cerraduras metálicas de calidad
- Armazón robusto y templado de aluminio
- Asa hergónómica
- 3 bisagras metálica
- Sujeción de la tapa reforzada

enthaltend/containing

	MM 8/10/11/12/13/14/15/16/17/19/22/24		3 m
	Geprüft nach DIN EN 166 F		200 mm
	9" / CE/EN 388-4131		500 g
	150 - 250 V		230 mm
	170 - 500 mm		200 mm
	MM 4,0 x 75 / 5,5 x 125 / 6,5 x 150		200 mm
	PH 1 / 2		250 mm
	200 mm		250 mm
	200 mm Gr. 18 mm		125 mm
	250 mm		MM 10/11/12/13/14/15/16/17/18/19/20/21/22/24/27/30/32
	180 mm		75 mm
	160 mm		■ R1 - R2 ⊖ 3,5 - 8 ● 2 - 8
	MM 1,5/2/2,5/3/4/5/6/8/10		+ PH 1 - 3 + PZ 1 - 3 * TT 9 - 40
	TX 10/15/20/25/27/30/40/45/50		● 115 mm ● 100 mm ● 125 mm
	205 mm		* TT 10-40 + PH2 ● 5/6 + PZ 2
			MM 4/4,5/5,5/6/7/8/9/10/11/12/13
			⊖ 3 x 120 mm ● 5 x 130 mm
			⊖ 5 x 150 mm ● 12 x 130 mm
			⊖ 3 x 120 mm ● 14 x 150 mm

Bestell-No./Order-No.	Art. No.	Maße · Dimensions		
5086750000	508675	460 x 370 x 170 mm	13300	1

508675-01

92-tlg./pcs./dlg./pces./pzs.



**NEU
NEW**

Montage Werkzeugkoffer Basic, 92-tlg.

Das umfangreiche Werkzeug-Set wird in einem robusten und abschließbaren Hartschalen-Koffer geliefert und ist bestens für mobilen Einsatz geeignet.

Tool Box Basic, 92 pcs.

The versatile tool set is supplied in a robust and lockable hard-shell case and is ideally suited for mobile use.

Montage gereedschapskoffer Basic, 92 pcs.

De omvangrijke gereedschapset wordt in een robuuste, afsluitbare, hardschalen koffer geleverd en is uitermate geschikt voor mobiele inzet.

Coffret à outils de montage Basic, 92 pcs.

Ce set d'outils complet est livré dans une mallette robuste et verrouillable à coque dure et convient parfaitement à une utilisation mobile.

Maletín de herramientas de montaje básico, 92 pcs.

El completo juego de herramientas se suministra suministrado en un robusto maletín rígido y es ideal para adecuado para un uso móvil.



enthaltend/containing	
	115 mm
	100 mm
	65 mm
	MM 4/4,5/5/5,5/6/7/8/9/10/11/12/13
	25 mm
	2/3/4/5/6/7/8
	PH 1/2/2/3
	PZ 1/2/2/3/4
	3,5/4,5/5,5/6,5
	TT 7/8/9/10/15/20/25/27/30/40
	3 m
	150 mm
	200 mm

enthaltend/containing	
	MM 8/10/11/12/13/14/15/16/17/19
	150 - 250 V
	MM 4,0 x 75 / 5,5 x 125 / 6,5 x 150
	PH 1 / 2
	200 mm
	Gr. 18 mm
	250 mm
	180 mm
	160 mm
	MM 1,5/2/2,5/3/4/5/6/8/10
	TX 10/15/20/25/27/30/40/45/50
	255 mm
	200 mm
	300 g
	230 mm

Bestell-No./Order-No.	Art. No.	Maße · Dimensions		
50867500100	508675-01	460 x 370 x 170 mm	10845	1

5081054

Rucksack für Werkzeugsortimente, leer

Hochwertiger Rucksack mit 32 innenliegenden und 4 außenliegenden Einsteckfächern, einem Laptopfach (bis 13,3"), sowie 16 Gummischlaufen für Werkzeuge aller Art. Der Rucksack wird aus strapazierfähigem Nylon gefertigt und ist durch die stabil genähten Einsteckfächer sowie die verstärkte Bodenplatte extrem langlebig.

Ausstattungsmerkmale:

Robuste Tragegriffe, ergonomisch gepolsterter Rückenbereich, verstellbare, weich gepolsterte Schulterriemen, rutschfeste, gummierte Bodenplatte zum Schutz vor Abnutzung und Nässe, Maßbandhalter, Schlüsselanhänger, mehrere Metallbefestigungsösen, stabile Reißverschlüsse.

Backpack for tool set, empty

High-quality backpack with 32 pockets, a laptop compartment (up to 13.3"), 4 external storage compartments and 16 rubber loops for tools of all kinds. The backpack is made from hard-wearing nylon and is extremely durable thanks to the sturdy sewn-in compartments and reinforced base plate.

Equipment features:

Robust carrying handles, ergonomically padded back area, adjustable, soft padded shoulder straps, non-slip, rubberised base plate to protect against wear and tear and moisture, tape measure holder, key fob, several metal fastening eyelets, sturdy zips.

Rugzak voor gereedschapsets, leeg

Hoogwaardige rugzak met 32 inwendige en 4 uitwendige insteekvakken, laptopvak (tot 13,3"), 16 rubberen banden voor allerlei gereedschappen. De rugzak is gemaakt van duurzaam nylon en is dankzij de solide gestikte insteekvakken en versterkte bodem extreem duurzaam.

Kenmerken:

robuuste draaggreep, ergonomisch gepolsterde achterzijde, verstellbare, zacht gepolsterde schouderbanden, rubberen anti-slip bodem tegen slijtage en vocht, rolmaat houder, sleutelhaak, meerdere metalen bevestigingsogen, robuuste ritsen.

Sac à dos pour assortiments d'outils, vide

Sac à dos de haute qualité avec 32 poches intérieures et 4 poches extérieures, un compartiment pour ordinateur portable (jusqu'à 13,3") et 16 boucles en caoutchouc pour toutes sortes d'outils. Le sac à dos est fabriqué en nylon résistant et a une durée de vie extrêmement longue grâce aux compartiments solidement cousus et à la plaque de fond renforcée.

Caractéristiques de l'équipement:

Poignées robustes, dos ergonomiquement rembourré, bretelles réglables et souples, plaque de fond antidérapante et caoutchoutée pour protéger de l'usure et de l'humidité, porte-mètre, porte-clés, plusieurs œillets de fixation en métal, fermetures éclair solides.

Mochila para surtido de herramientas, vacía

Mochila de alta calidad con 32 bolsillos, un compartimento para portátil (hasta 13,3"), 4 compartimentos de almacenamiento externos y 16 trabillas de goma para herramientas de todo tipo. La mochila está fabricada en nylon resistente y es extremadamente duradera gracias a los robustos compartimentos cosidos y a la placa base reforzada.

Características de equipamiento:

Robustas asas de transporte, zona de la espalda ergonómicamente acolchada, tirantes acolchados suaves y ajustables, placa base de goma antideslizante para proteger contra el desgaste y la humedad, soporte para cinta métrica, llavero, varios ojales metálicos de fijación, cremalleras resistentes.

NEU
NEW





INFO

75, 121, 141

Neben dem leeren Rucksack bieten wir auch ein VDE Elektriker Sortiment, ein Sanitär Sortiment sowie ein allgemeines Werkzeug Sortiment gemeinsam mit dem Rucksack an.

In addition to the empty backpack, we also offer a VDE electrician's range, a plumbing range and a general tool range together with the backpack.



Bestell-No./Order-No.	Art. No.	Volumen · Volume	Maße · Dimensions		
50810540000	5081054	23 l	460 x 360 x 170 mm	2160	1

5081054-91

91-tlg./pcs./dlg./pces./pzs.

**NEU
NEW**

**Montage-Werkzeugsortiment
im Rucksack**

Hochwertiger Rucksack mit 32 innen-
liegenden und 4 außenliegenden
Einsteckfächern, einem Laptopfach (bis
13,3"), sowie 16 Gummischlaufen für
Werkzeuge aller Art.

**Installation tool set
in backpack**

High-quality backpack with 32 pockets,
a laptop compartment (up to 13.3"), 4
external storage compartments and 16
rubber loops for tools of all kinds.

**Montage gereedschapset
in rugzak**

Hoogwaardige rugzak met 32 inwendige
en 4 uitwendige insteekvakken, laptopvak
(tot 13,3"), 16 rubberen banden voor
allerhande gereedschappen.

**Assortiment d'outils de
montage dans un sac à dos**

Sac à dos de haute qualité avec
32 poches intérieures et 4 poches
extérieures, un compartiment pour
ordinateur portable (jusqu'à 13,3"), ainsi
que 16 passants en caoutchouc pour
toutes sortes d'outils.

**Surtido de herramientas de
montaje en mochila**

Mochila de alta calidad con 32
bolsillos, un compartimento para portátil
(hasta 13,3"), 4 compartimentos de
almacenamiento externos y 16 trabillas
de goma para herramientas de todo tipo.



enthaltend/containing

- 3 m
- 250 mm
- 180 mm
- 180 mm
- 150 - 250 V
- 300 g
- Gr. 18 mm
- 230 mm
- 205 mm
- 250 mm
- MM 8/9/10/11/
13/14/17/19
- MM 1,5/2/2,5/
3/4/5/6/8/10
- MM 4,0 x 75 /
5,5 x 125 /
6,5 x 150
- PH 1 / 2
- 125 mm
- MM 8/10/11/13/
15/17/18/19/22/24

enthaltend/containing

- 115 mm
- 100 mm
- 65 mm
- MM 4/4,5/5/5,5/6/7/
8/9/10/11/12/13
- 25 mm
- 2/3/4/5/6/7/8
- PH 1/2/2/3
- PZ 1/2/2/3/4
- 3,5/4,5/5,5/6,5
- TT 7/8/9/10/15/
20/25/27/30/40

Bestell-No./Order-No.	Art. No.	Maße · Dimensions		
50810549100	5081054-91	460 x 360 x 170 mm	9900	1

5081052-9

92-tlg./pcs./dlg./pces./pzs.



Montage-Werkzeugsortiment im Rucksack

Hochwertiger Rucksack mit separater Innentasche für Werkzeuge aller Art.

Tool assortment in backpack
High quality backpack with separate inner pocket for all kinds of tools.

Montage gereedschapset in rugzak

Hoogwaardige rugzak met apart binnenvak voor diverse gereedschappen.

Assortiment d'outils en sac à dos

Sac à dos de haute qualité avec poche intérieure séparée pour toute sorte d'outils.

Juego de herramientas en mochila

Mochila de alta calidad con bolsillo interior separado para herramientas de todo tipo.



enthaltend/containing

	5 m
	250 mm
	180 mm
	180 mm
	150 - 250 V
	300 g
	150 mm
	10 Stk./pcs.
	Gr. 18 mm
	170 - 500 mm
	230 mm
	205 mm
	250 mm
	MM 8/9/10/11/ 13/14/17/19
	MM 1,5/2/2,5/ 3/4/5/6/8/10
	Geprüft nach DIN EN 166 F
	MM 4,0 x 75 / 5,5 x 125 / 6,5 x 150
	PH 1 / 2
	150 mm
	■ R1 - R2 + PH 1 - 3 ○ 3,5 - 8 - PZ 1 - 3 ● 2 - 8 * TT 9 - 40
	125 mm
	MM 8/10/11/13/ 15/17/18/19/22/24
	MM 20,8



Bestell-No./Order-No.	Art. No.	Maße · Dimensions		
50810529200	5081052-9	460 x 350 x 180 mm	10600	1

5081052-5

50-tlg./pcs./-dlg./pces./pzs.

Dachdecker-Sortiment im Rucksack

Hochwertiger Rucksack mit separater Innentasche für Werkzeuge aller Art.

Slater assortment in backpack

High quality backpack with separate inner pocket for all kinds of tools.

Dakdekkers gereedschapset in rugzak

Hoogwaardige rugzak met apart binnenvak voor diverse gereedschappen.

Assortiment pour couvreur en sac à dos

Sac à dos de haute qualité avec poche intérieure séparée pour toute sorte d'outils.

Juego de herramientas para trabajos en tejados



Mochila de alta calidad con bolsillo interior separado para herramientas de todo tipo.

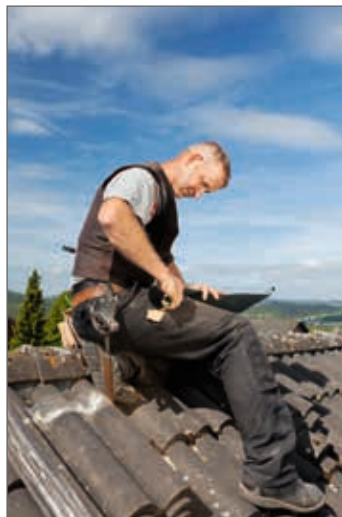

enthaltend/containing

-  5 m
-  195 - 570 mm
-  230 mm
-  200 mm
-  260 mm
-  400 mm
-  200 mm
-  200 mm
-  200 mm / 8"
-  400 mm
-  Geprüft nach
DIN EN 166 F
-  CE/EN 388-4131
-  Gr. 18 mm
-  600  g
-  300 mm / 11,8"
-  17+22er
Zahnung
teeth per inch
-  315 mm
 19 x 22
-  R1-R2 + PH1-3
 3,5-8 + PZ 1-3
 2-8  TT9-40



Bestell-No./Order-No.	Art. No.	Maße · Dimensions		
50810525000	5081052-5	460 x 350 x 180 mm	8100	1

5081052

Rucksack für Werkzeugsortimente, leer

Hochwertiger Rucksack mit separater Innentasche für Werkzeuge aller Art.

Backpack for tool set, empty
High quality backpack with separate inner pocket for all kinds of tools.

Rugzak voor gereedschapsets, leeg

Hoogwaardige rugzak met apart binnenvak voor diverse gereedschappen.

Sac à dos vide pour assortiment d'outillage

Sac à dos de haute qualité avec poche intérieure séparée pour toutes sortes d'outils.

Mochila para juego de herramientas, vacía

Mochila de alta calidad con bolsillo interior separado, para herramientas de todo tipo.



Ausstattungsmerkmale:

- Gepolsterte Schultergurte mit Handytasche
- Netz-Außentaschen
- Seitentasche mit Fach für Visitenkarten
- Elastische Halteriemens
- Separate Werkzeugtasche
- Viele Einsteck- und Klemmhaltemöglichkeiten
- Innenfächer für Schreibunterlagen/Laptop/Tablet
- Robuste und stabile Bauform mit vielen Extras
- Hoher Tragekomfort, ergonomische Form

Features:

- Upholstered shoulder belts with cell phone pocket
- Outside mesh pockets at the front and on one side
- Side pocket with business card holder
- Elastic holding straps
- Separate tool bag for convenient removal
- Multiple storage- and locking-compartments
- Interior compartments for writing pads/laptop/tablet PC
- Robust and sturdy design with various extras
- Excellent wearing comfort, ergonomic shape

Uitgerust met:

- Gepolsterde schouderbanden met gsm-vakje
- Gaas-vakken aan de buitenkant
- Zijvak met ruimte voor visitekaartjes
- Elastische sluitriemen
- Aparte gereedschaptas
- Veel insteek- en klemmogelijkheden
- Binnenvakken voor schrijfbenedigheden/laptop/tablet
- Robuust ontwerp met vele extra's
- Uitstekend draagcomfort, ergonomische vorm

Caractéristiques:

- Bretelles rembourées avec poche pour téléphone cellulaire
- Poches extérieures devant et sur un côté
- Poche latérale pour cartes de visite
- Alvéoles élastiques
- Sac à outils séparé pour enlèvement facile
- Plusieurs compartiments de stockage et de verrouillage
- Compartiment intérieur pour ordinateur portable/tablette PC
- Design robuste avec de nombreux extras
- Confort excellent et forme ergonomique

Características del equipamiento:

- Tirantes acolchados con bolsillo para móvil
- Bolsillos de redicilla delanteros y a un lateral
- Bolsillo lateral para guardar tarjetas de visita
- Tirantes elásticos de sujeción
- Bolsa de herramientas separada y extraíble
- Compartimentos múltiples para almacenaje
- Compartimentos interiores para anotaciones pads/laptop/tablet PC
- Diseño robusto y resistente con varios extras
- Muy confortable para llevar, con diseño ergonómico



Bestell-No./Order-No.	Art. No.	Maße · Dimensions		
50810520000	5081052	460 x 350 x 180 mm	2500	1

50848-1

Umhängetasche für Werkzeuge, leer

Hochwertige Aufbewahrungstasche mit Klemmhaltesystem sowie Einsteckfächern für Werkzeuge aller Art.

Ausstattungsmerkmale:

- Gepolsterter Trageriemen
- Robuster Tragegriff
- Ausklappbarer Stellfuß für sicheren Stand
- Kleinteilmagazin
- Geschütztes, gepolstertes Laptop-Fach
- Zusätzliches Fach für Dokumente

Shoulder bag for tools, empty

Premium-quality storage bag with locking system and compartments for all kinds of tools.

Features:

- Cushioned carrying strap
- Robust carrying handle
- Fold-out foot for a secure stand
- Small parts magazine
- Protected, cushioned laptop-compartment
- Additional compartment for documents

Leren gereedschapstas

Hoogwaardige gereedschapstas met gereedschapsklemmen en insteekvakken voor allerhande gereedschappen.

Uitgerust met:

- Gepolsterde draagriem
- Robuuste draaggreep
- Uitklapbare stelvoet
- Vakkendoos voor kleine materialen
- Beschermd, gepolsterd laptopvak
- Extra vak voor documenten

Sacoché à outils, vide

Alvéoles de rangement de haute qualité avec système de serrage, ainsi que des poches pour tous types d'outils.

Caractéristiques:

- Bandoulière rembourrée
- Poignée de transport robuste
- béquille pour plus de stabilité
- Compartiment pour petites pièces
- Compartiment rembourré pour ordinateur portable
- Compartiments à documents

Cartera para herramientas, vacío

Cartera de calidad, con pinzas y bolsillos para guardar herramientas de todo tipo.

Características del equipamiento:

- Correa acolchada
- Asa robusta
- Pie plegable para una colocación segura
- Recipiente para piecero pequeño
- Compartimento acolchado para lap-top
- Compartimento adicional para documentos



Bestell-No./Order-No.	Art. No.	Maße · Dimensions		
50848010000	50848-1	555 x 410 x 180 mm	2400	1

50807-92

92-tlg./pcs./dlg./pcs./pzs.



Montage-Werkzeugsortiment in Umhängetasche

Hochwertige Aufbewahrungstasche mit Klemmhaltesystem sowie Einsteckfächern für Werkzeuge aller Art.

Ausstattungsmerkmale:

- Gepolsterter Trageriemen
- Robuster Tragegriff
- Ausklappbarer Stellfuß für sicheren Stand
- Kleinteilmagazin
- Geschütztes, gepolstertes Laptop-Fach
- Zusätzliches Fach für Dokumente

Tool assortment in shoulder bag

Premium-quality storage bag with locking system and compartments for all kinds of tools.

Features:

- Cushioned carrying strap
- Robust carrying handle
- Fold-out foot for a secure stand
- Small parts magazine
- Protected, cushioned laptop-compartment
- Additional compartment for documents

Gereedschapstas

Hoogwaardige gereedschapstas met gereedschapsklemmen en insteekvakken voor allerhande gereedschappen.

Uitgerust met:

- Gepolsterde draagriem
- Robuuste draaggreep
- Uitklapbare stelvoet
- Vakkeendoos voor kleine materialen
- Beschermd, gepolsterd laptopvak
- Extra vak voor documenten

Sélection d'outils en sacoche textile

Sacoche de rangement de haute qualité avec système de serrage, ainsi que des poches pour tous types d'outils.

Caractéristiques:

- Bandoulière rembourrée
- Poignée de transport robuste
- Béquille intégrée pour plus de stabilité
- Pour petites pièces
- Protégé, compartiment rembourré pour ordinateur portable
- Compartiments à documents

Conjunto de herramientas en cartera para herramientas

Cartera de calidad, con pinzas y bolsillos para guardar herramientas de todo tipo.

Características del equipamiento:

- Correa acolchada
- Asa robusta
- Pie plegable para una colocación segura
- Recipiente para piezas pequeñas
- Compartimento acolchado para lap-top
- Compartimento adicional para documentos

HEYTEC
BESTSELLER

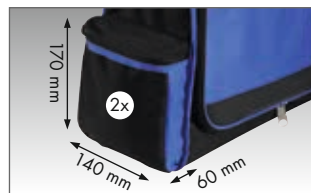
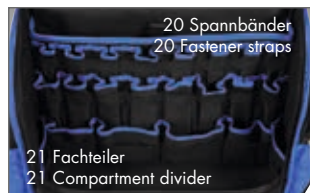

enthaltend/containing

5 m	170 - 500 mm
250 mm	Geprüft nach DIN EN 166 F
250 mm	230 mm
MM 8/9/10/11/13/14/17/19	MM 4,0 x 75 / 5,5 x 125 / 6,5 x 150
180 mm	PH 1 / 2
160 mm	150 mm
MM 1,5/2/2,5/3/4/5/6/8/10	R1 - R2
150 - 250 V	3,5 - 8
300 g	2 - 8
150 mm	PH1 - 3
150 mm, Stahl, 10 Stk./pcs.	PZ 1 - 3
Gr. 18 mm	TT 9 - 40
	205 mm
	250 mm
	125 mm
	MM 8/10/11/13/15/17/18/19/22/24
	MM 20,8

Bestell-No./Order-No.	Art. No.	Maße · Dimensions		
50807892000	50807-92	555 x 410 x 180 mm	9500	1

9088070

Werkzeugrolltasche, leer

Rolltasche mit 15 Facheinteilungen, gefertigt aus schwarzem Polyester, PP-Einfassung in dunkelblau, mit Gurt und Schnalle. Ohne Aufdruck.

Tool wallet, empty

With 15 compartments made from black polyester with dark blue lining with strap and clasp, neutral.

Gereedschapsroltas, leeg

Roltas, zonder inhoud, met 15 vakken, vervaardigd uit zwart polyester, donkerblauwe PP afwerking, met sluitriem en gesp. Zonder opdruk.

Trousse à outils, vide

Trousse à 15 compartiments, en polyester noir, bords bleu foncé avec lanière et boucle, sans impression.

Bolsa de herramientas, enrollable, vacío

Bolsa enrollable, vacía, con 15 bolsillos, de poliéster negro, bordes de polipropileno azul marino, con cinta y hebilla, neutral.



Bestell-No./Order-No.	Art. No.	Maße · Dimensions	g	
90880701500	9088070	670 x 340 mm	750	5

50890-30

8-tlg./pcs./-dlg./pces./pzs.

Haushalts-Werkzeugtasche

Zusammenstellung der gebräuchlichsten Qualitätswerkzeuge für Haushalt und Büro; für zuhause oder unterwegs.

Praktisch und platzsparend, Kunstledertasche mit Verschluss. Optimal auch in der Werbebranche einsetzbar.

Household tool wallet

Assortment of most commonly used quality tools for office and house-hold, for at home and on the road. Practical and suitably, tool wallet of imitation leather with inter-locking clasp fastener. Particularly suitable for marketing through advertising and publicity companies.

Gereedschapsset voor thuis

Overzicht van de meest algemene kwaliteitgereedschappen voor gebruik in en om huis en kantoor; voor thuis en onderweg. Praktisch en plaatsbesparend, verpakt in kunstleren tas met sluiting. Ook uitstekend geschikt als reclameobject.

Trousse d'outillage à usage domestique

Composition d'outillage de qualité pour l'entretien de la maison, du bureau à domicile ou en voyage. Rangés en trousse similicuir pratique et compacte, avec fermoir. Optimal aussi dans le domaine des cadeaux d'affaires.

Herramientas de calidad

Conjunto de herramientas de calidad, para uso doméstico, en la oficina y de viaje. Presentadas en una bolsa de plástico práctica y de reducidas dimensiones, con cierre. Muy recomendable para regalo publicitario.



enthaltend/containing	
	200 mm
	300 g
	255 mm
	230 mm
	250 mm
	170 mm
+	6,5 mm x PH 2
	150 - 250 V

Bestell-No./Order-No.	Art. No.	Maße · Dimensions	g	
50890300300	50890-30	480 x 365 x 30 mm	1305	1

508807-1

Bohrmaschinen- Gürteltasche, leer

Aus hochwertigem Polyester, für Akkuschauber, Bohrmaschinen oder Bohrschrauber, gepolstert mit Sicherheitschnalle.

Power drill belt pouch, empty
Made of high quality polyester, for cordless screwdriver, power drill or boring machine, upholstered with safety clasp.

Boormachine gereedschapschort, leeg

Van hoogwaardig polyester, voor accuschroefmachines, boormachines of schroefboormachines, gepolstert, met veiligheidsclip.



Sac de ceinture pour perceuse, vide

En polyester de haute qualité, pour perceuse-visseuse électrique, rembourré et équipé d'une boucle de sécurité.

Cinturón portaherramientas para taladros, vacío

De poliester de alta calidad, para destornilladores eléctricos, taladros o taladro atornillador, acolchado con hebilla de seguridad.



Bestell-No./Order-No.	Art. No.	Maße · Dimensions		
50880700100	508807-1	160 x 360 x 90 mm	217	1

508807-2

Gürteltasche, leer

Aus hochwertigem Polyester, gepolstert mit Hammerring, viel Platz für Werkzeug und Kleinteile sowie Aufnahmepunkt für Maßbänder und Halter für Isolierbandrollen. Ideal für Elektriker, Zimmermänner und Sanitär.

Belt pouch, empty
Made of high quality polyester with hammerring, space for tools, small parts and position point for measuring tapes. Ideal for electricians, carpenters and plumbers.



Gereedschapsschort, leeg
Van hoogwaardig polyester, gepolstert, met hamerbeugel, veel ruimte voor gereedschap en kleine onderdelen, met opbergvak voor rolbandmaten en houder voor isolatietape. Ideaal voor elektriciens, timmerlieden en loodgieters.

Porte-outils à ceinture, vide
En polyester de haute qualité, avec bague de suspension pour marteau, beaucoup de place pour les outils et les petites pièces et attache pour mètre-ruban. Idéal pour électriciens, charpentiers et plombiers.

Cinturón portaherramientas, vacío

De poliester de alta calidad con rueda para martillos, mucho espacio para herramientas y piezas pequeñas así como punto de referencia para las cintas métricas. Ideal para electricistas, carpinteros y fontaneros.



Bestell-No./Order-No.	Art. No.	Maße · Dimensions · Medidas		
50880700200	508807-2	380 x 300 x 100 mm	344	1

508807-3

Gürteltasche, leer

Aus hochwertigem Polyester, Facheinteilung für Zangen, Schraubendreher, Bandmaß und Halter mit Isolierband-rollen. Ideal für Elektriker, Zimmermänner und Sanitär.

Belt pouch, empty

Made of high quality polyester, space for pliers, screwdrivers, measuring tapes and holder for insulating tapes. Ideal for electricians, carpenters and plumbers.

Gereedschapsschort, leeg

Van hoogwaardig polyester, vakindeling voor tangen, schroevendraaiers, rolbandmaat en houder voor isolatietape. Ideaal voor elektriciëns, timmerlieden en loodgieters.

Porte-outils à ceinture, vide

En polyester de haute qualité, emplacements pour pinces, tournevis, mètre-ruban et support pour rouleaux de bandes isolantes. Idéal pour électriciens, charpentiers et plombiers.

Cinturón portaherramientas, vacío

De poliester de alta calidad, bolsillos para alicates, llaves de vaso, cinta métrica y soporte para rollos de cinta aislante. Ideal para electricistas, carpinteros y fontaneros.



Bestell-No./Order-No.	Art. No.	Maße · Dimensions		
50880700300	508807-3	460 x 270 x 320 mm	344	1

508807-4

Hammer-Gürteltasche, leer

Aus hochwertigem Polyester mit schwenkbarem Stahlbügel für alle Hammerarten inklusive Halterung für Gerüstbauknarren.

Hammer belt pouch, empty

Made of high quality polyester with swivelling steel clevis for all type of hammers, including holder for construction tool.

Hamerholster, leeg

Fan hoogwaardig polyester met zwenkbare stalen beugel voor alle typen hamers, incl. houder voor verfpuntratel.

Porte-marteau à ceinture, vide

En polyester de haute qualité avec étrier en acier orientable pour tous types de marteaux et supports pour clés à cliquet d'échaffaudage.

Cinturón portaherramientas para martillos, vacío

De poliester de alta calidad con colgador de acero para todo tipo de martillos incluido soporte para herramientas para el montaje de andamios.

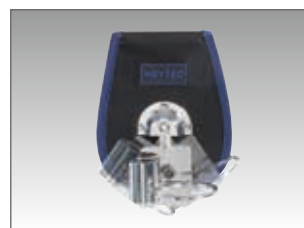

Bestell-No./Order-No.	Art. No.	Maße · Dimensions		
50880700400	508807-4	280 x 170 x 90 mm	500	1



5 KAPITEL CHAPTER

DREHMOMENTSCHLÜSSEL

verstellbar
mit Hebelumschaltknarre
Einsteckknarre
Einsteckmaulschlüssel

CLÉS DYNAMOMÉTRIQUE

réversible
avec cliquet réversible
Cliquet à emmanchement
Clé à fourche à emmanchement

TORQUE WRENCHES

reversible
with reversible ratchet
ratchet heads
Open ended jaw wrench insert tools

LLAVES DINAMOMÉTRICAS

reversible
con carraca reversible
Cabezal de carraca
Llaves para tornillos tipo Express

DRAAIMOMENTSLEUTELS

omschakelbaar
met omschakelpal
Insteekratel
Insteeksteeksleutel

50888021080
50888035080

**Drehmomentschlüssel,
 verstellbar
 mit Einhand-Spannzange**

Aufgrund der Stillson Einhand Zange ist der Drehmomentschlüssel bestens geeignet für runde, ovale und eckige Geometrien, die außerhalb von gängigen DIN Normen liegen. Die gehärtete Stellmutter verhindert mit der Federung ein ungewolltes Verstellen und sorgt für höchste Selbstklemmung. Besonders geeignet im Bauhandwerk für Eisenflechter und Stahlbetonbauer sowie im Maschinen- und Anlagenbau.

**Adjustable torque wrench
 with one-hand clamp**

Due to the Stillson one-handed pliers, the torque spanner is ideally suited for round, oval and angular geometries that lie outside common DIN standards. The hardened adjusting nut with the spring prevents unintentional adjustment and ensures maximum self-clamping. Particularly suitable in the building trade for ironworkers and reinforced concrete builders as well as in mechanical and plant engineering.

**Verstellbare momentsleutel
 met eenhand pijptang**

Dankzij de Stillson eenhandige tang is de momentsleutel bij uitstek geschikt voor ronde, ovale en hoekige geometrieën die buiten de gangbare DIN-normen vallen. De geharde stelmoer met veer voorkomt onbedoelde verstelling en zorgt voor maximale zelfklemming. Bijzonder geschikt in de bouwsector voor ijzerwerkers en bouwers van gewapend beton, alsook in de machinebouw en de installatietechniek.

**Clé dynamométrique, réglable
 avec clé à tuyau**

Grâce à la pince Stillson à une main, la clé dynamométrique est parfaitement adaptée aux géométries rondes, ovales et angulaires qui se situent en dehors des normes DIN courantes. L'écrou de réglage trempé avec le ressort empêche tout réglage involontaire et assure un auto-serrage maximal. Convient particulièrement bien dans le bâtiment pour les monteurs de charpentes métalliques et les constructeurs de béton armé, ainsi que dans la construction de machines et d'installations.

**Llave dinamométrica, ajustable
 con pinza de una mano**

Gracias a los alicates de una mano Stillson, la llave dinamométrica es ideal para geometrías redondas, ovaladas y angulares que quedan fuera de las normas DIN comunes. La tuerca de ajuste endurecida con el muelle evita el ajuste involuntario y garantiza la máxima autofijación. Especialmente adecuado en el sector de la construcción para los ferrallistas y los constructores de hormigón armado, así como en la ingeniería mecánica y de instalaciones.



Einfaches Verschrauben von Bewehrungsstäben und Muffenverbindungen für Stahlbetonanwendungen. Die Einhand-Spannzange ist bestens geeignet für runde, ovale und eckige Geometrien. Für alle namhaften Hersteller von Bewehrungstechniken (z.B. Lenton, Halfen etc.). Die gehärtete Stellmutter und die Spannzange verhindern mit der Federzentrierung ein ungewolltes Verstellen und sorgen für höchste Sicherheit bei der Selbstklemmung.

- Drehmomenteinstellung von 40-210 Nm, Spannbereich 5-40 mm
- Drehmomenteinstellung von 70-350 Nm, Spannbereich 10-60 mm

Easy screwing of reinforcing rods and socket joints for reinforced concrete applications. The one-hand clamp is best suited for round, oval and square shapes. For application with products of all renowned manufacturers of reinforcement gear (e.g. Lenton, Halfen etc.). The hardened adjusting nut and grips in combination with the spring centering prevent an unintended mechanical shift of the wrench ensuring utmost safety of the self-clamping.

- Torque adjustment range 40-210 Nm, clamping range 5-40 mm
- Torque adjustment range 70-350 Nm, clamping range 10-60 mm

Lieferung in gepolsterter Umhängetasche mit Trageriemen zum sicheren Transport zum Einsatzort, schützt vor Schmutz und Nässe. Supplied in a cushioned bag with carrying strip for safe transport to the building site, optimum dirt and moisture protection.



Bestell-No./Order-No.	Ø mm	Nm	mm	g	
50888021080	600	40-210	5-40	2200	1
50888035080	730	70-350	10-60	3700	1

50879
50880
50882
50885
50886

1/4" 3/8" 1/2" 3/4"

Drehmomentschlüssel
mit Hebelumschaltknarre
Chrom-Vanadium in Kunststoffbox.

Torque wrenches
with reversible ratchet
Chrome-Vanadium in plastic box.

Momentsleutel
met omschakelpal
Chroom-Vanadium in kunststof koffer.

Clé dynamométrique
avec cliquet réversible
Chrome-Vanadium en coffret plastique.

Llaves dinamométrica
con carraca reversible
Cromo Vanadio en estuche de
polipropileno.

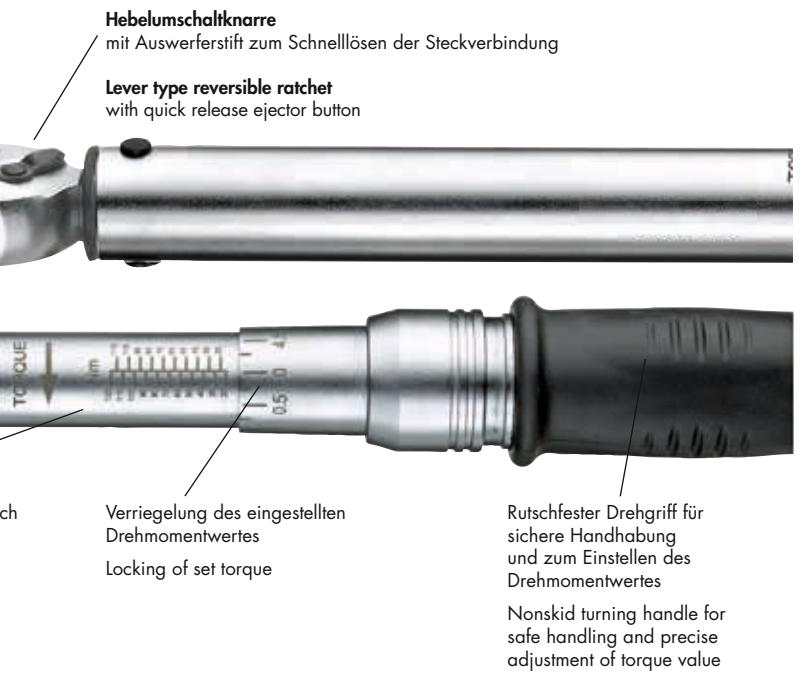

Hebelumschaltknarre
mit Auswerferstift zum Schnelllösen der Steckverbindung

Lever type reversible ratchet
with quick release ejector button

Gut einstellbare, deutlich
lesbare Skala
Clearly visible scale

Verriegelung des eingestellten
Drehmomentwertes
Locking of set torque

Rutschfester Drehgriff für
sichere Handhabung
und zum Einstellen des
Drehmomentwertes
Nonskid turning handle for
safe handling and precise
adjustment of torque value

Bestell-No./Order-No.	Art. No.	■	Nm	CLD mm	⚖	📦
50879000080	50879	1/4"	3-15	190-210	290	1
50880000080	50880	1/4"	4-20	300-320	865	1
50882000080	50882	3/8"	20-120	405-435	1665	1
50885000080	50885	1/2"	40-200	485-510	2020	1
50886000080	50886	3/4"	100-600	1035-1052	5047	1

50895-1

72 Zähne/teeth/tanden/dents/dientes

Einsteckknarre

Chrom-Vanadium, verchromt, umschaltbar.

Reversible ratchet heads

Chrome-Vanadium, chromium plated, with reversible ratchet.

Insteekratel

Chroom-Vanadium, verchromd, omschakelbaar.

Cliquet à emmanchement

Chrome-Vanadium, chromé, avec cliquet réversible.

Cabezal de carraca

Cromo Vanadio, cromada con carraca reversible.



Bestell-No./Order-No.	Art. No.		L3 mm	D mm	H mm	für • for		
50895100080	50895-1	1/2"	25,00	37,00	43,00	50895	250	1

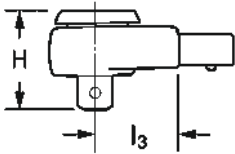

50895-31

Einsteckmaulschlüssel

Open ended jaw wrench insert tools

Insteeksteeksluutel

Clé à fourche à emmanchement

Llave de boca abierta



Chrom-Vanadium
Chrome-Vanadium

Bestell-No./Order-No.	Art. No.		L3 mm	D mm	H mm	für • for		
* 50895311380	50895-31	13	25,0	30,0	7,0	50895	125	1
* 50895311480	50895-31	14	25,0	32,0	7,0	50895	130	1
* 50895311780	50895-31	17	25,0	37,0	9,0	50895	130	1
* 50895311880	50895-31	18	25,0	39,0	9,0	50895	145	1
* 50895312280	50895-31	22	25,0	47,0	11,0	50895	165	1
* 50895312480	50895-31	24	25,0	51,0	11,0	50895	170	1
* 50895312780	50895-31	27	32,5	58,5	13,0	50895	215	1
* 50895313080	50895-31	30	32,5	63,0	13,0	50895	245	1

* Auslauf / Discontinued

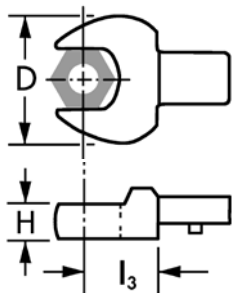



6 KAPITEL CHAPTER

ZANGEN UND SCHEREN

Montage
VDE
Sanitär
Universal

PINCES ET CISEAUX

Montage
VDE
Sanitaire
Universel

PLIERS AND SCISSORS

Contruction
VDE
Sanitary
Universal

ALICATES Y CIZALLAS

Montaje
VDE
Sanitarios
Universales

TANGEN EN SCHAAREN

Montage
VDE
Sanitair
Universeel

50253

Wasserpumpenzange

Mit durchgestecktem Gleitgelenk, Chrom-Vanadium, lackiert, teilweise geschliffen, Griffe kunststoffbeschichtet.

Water pump pliers

With box joints, Chrome-Vanadium, lacquered, partly ground, plastic coated handles.

Waterpomptang

Met doorgestoken scharnier Chrom-Vanadium, gelakt, gedeeltelijk geslepen, grepen met kunststof overtrokken.

Pince multiprise

Charnière entrepassée et glissière, Chrome-Vanadium, laquée partiellement meulée, poignées gainées plastique.

Tenaza para bombas de agua

Unión machihembrada, Cromo Vanadio, pintada, parcialmente pulida, mangos plastificados.



Bestell-No./Order-No.	Art. No.	Clamp mm	Weight g	Length mm
5025320834	50253	250	385	1

5081330/5081331

Eckrohrzangen

Kopf induktiv gehärtet und poliert, pulverbeschichtet, Rolle unverlierbar.

Elbow pipe wrenches

Face inductive hardened and polished, powder coated, roll captive.

Hoekpijptang

Chroom-Vanadium, kop inductief gehard en gepolijst, poedergecoat.

Clé à tube

Tête trempée par induction et polie, revêtement par pulvérisation, roulette imperdable.

Llaves para apretar los tubos en ángulos

Cabezal inductivo templado y pulido, con recubrimiento pulvimetalúrgico, rollo imperdible.



5081330



5081331

Bestell-No./Order-No.	Art. No.	Clamp mm	Clamp "	Weight g	Length mm
50813301020	5081330	320	1	800	1
50813301520	5081330	425	1.1/2	1450	1
50813311020	5081331	320	1	760	1
50813311520	5081331	425	1.1/2	1450	1

50831617534
50831624034
50831630034

NEU
NEW
 175 mm

Wasserpumpenzange

Geschmiedet und gehärtet. Öffnungsweite fest arretierbar, Entriegelung erfolgt durch Druckknopf. Tauchisolierte Griffe sorgen für ein sicheres Griffgefühl. Schwarze Lackierung, Glanzpolitur der Backen.

Water pump pliers

Forged and hardened. Opening width can be firmly locked, unlocking by push button. Plastic-coated handles provide a secure grip feeling. Black lacquer finish, polished jaws.

Waterpomptang

Gesmeed en gehard. Breedte opening stevig afsluitbaar, ontgrendeld door drukknop. Handgrepen met dip-isolatie zorgen voor een stevige grip. Zwarte lakafwerking, glanzend gepolijste bekken.

Pince multiprise

Forgée et trempée. Ouverture verrouillable, déverrouillage par bouton-poussoir. Poignées isolées par immersion pour une prise en main sûre. Peinture noire, polissage brillant des mâchoires.

Tenaza para bombas de agua

Forjado y endurecido. La anchura de apertura puede bloquearse firmemente, desbloqueándose mediante pulsador. Las empuñaduras recubiertas de plástico proporcionan una sensación de agarre seguro. Acabado lacado en negro.



Bestell-No./Order-No.	Öffn. mm	max. Öffn. mm	Gewicht g	Stückzahl
50831617534	175	max. 32 mm	220	1
50831624034	240	max. 36 mm	330	1
50831630034	300	max. 52 mm	570	1

50831603034

NEU
NEW

Wasserpumpenzangensatz, 3-tlg.

Geschmiedet und gehärtet. Öffnungsweite fest arretierbar, Entriegelung erfolgt durch Druckknopf. Tauchisolierte Griffe sorgen für ein sicheres Griffgefühl. Schwarze Lackierung, Glanzpolitur der Backen. In praktischer Rolltasche.

Water pumppliers set, 3 pcs.

Forged and hardened. Opening width can be firmly locked, unlocking by push button. Plastic-coated handles provide a secure grip feeling. Black lacquer finish, polished jaws. In practical roll-up bag.

Water pumppliers set, 3 dlj.

Gesmeed en gehard. Breedte opening stevig afsluitbaar, ontgrendeld door drukknop. Handgrepen met dip-isolatie zorgen voor een stevige grip. Zwarte lakafwerking, glanzend gepolijste op de bekken. In praktische oprolbare tas.

Jeu de pinces à pompe à eau, 3 pcs.

Forgée et trempée. Ouverture verrouillable, déverrouillage par bouton-poussoir. Poignées isolées par immersion pour une prise en main sûre. Peinture noire, polissage brillant des mâchoires. Dans une poche enroulable pratique.

Alicates para bombas de agua 3 pzs.

Forjado y endurecido. La anchura de apertura puede bloquearse firmemente, desbloqueándose mediante pulsador. Las empuñaduras recubiertas de plástico proporcionan una sensación de agarre seguro. Acabado lacado en negro, mordazas pulidas. En práctica bolsa enrollable.



Bestell-No./Order-No.	enthaltend · containing	Maße · Dimensions	Stückzahl	Stückzahl
50831603034	50831617534 - 175 mm 50831624034 - 240 mm 50831630034 - 300 mm	380 x 200 mm	1200	1

- Griffe mit 2-K Kunststoffhandschutz
- 2K plastic handle
- greep uit 2 componenten kunststof
- Poignées revêtues bimatière
- mangos con funda de plástico 2K



146-147

5081209

DIN ISO 5745

Flachrundzange, gerade

Kopf geschliffen und lackiert,
Schneide für mittelharten Draht.

Snipe nose plier, straight
Head ground and lacquered,
cutting edges for middlehard wire.

Telefoontang, recht

Kop gepolijst en gelakt,
knipt middelharde draad.

Pince à becs demi-ronds, droits

Tête chromée et laquée,
pour fil de dureté moyenne.

Alicate de radio, recto

Cabeza amolada y barnizada,
cortante para alambre semi-duro.



Bestell-No./Order-No.	Art. No.	CLD mm	g	1
50812082042	5081208	200	185	1

5081209

DIN ISO 5745

Flachrundzange, 45° abgewinkelt

Kopf geschliffen und lackiert,
Schneide für mittelharten Draht.

Snipe nose plier, 45° angle
Head ground and lacquered,
cutting edges for middlehard wire.

Telefoontang, 45° gebogen

Kop gepolijst en gelakt,
knipt middelharde draad.

Pince à becs demi-ronds, coudés à 45°

Tête chromée et laquée,
pour fil de dureté moyenne.

Alicate de radio, curvo a 45°

Cabeza amolada y barnizada,
cortante para alambre semi-duro.



Bestell-No./Order-No.	Art. No.	CLD mm	g	1
50812092042	5081209	200	185	1

5081200

DIN ISO 5746

Kombinationszange

Kopf geschliffen und lackiert,
Schneide für mittelharten Draht.

Combination plier
Head ground and lacquered,
cutting edges for middlehard wire.

Combinatietang

Kop gepolijst en gelakt,
knipt middelharde draad.

Pince universelle

Tête chromée et laquée,
pour fil de dureté moyenne.

Alicate universal

Cabeza amolada y barnizada,
cortante para alambre semi-duro.



Bestell-No./Order-No.	Art. No.	CLD mm	g	1
50812001842	5081200	180	260	1

- Griffe mit 2-K Kunststoffhandschutz
- 2K plastic handle
- greep uit 2 componenten kunststof
- Poignées revêtues bimatière
- mangos con funda de plástico 2K



146-147

5081212

DIN ISO 5749

Kraftseitenschneider

Spezialstahl, Kopf geschliffen und lackiert, Schneide für harten Draht (Piano Draht).

Diagonal cutting nipper

Head ground and lacquered, cutting edges for piano wire.

Kracht zijsnijtang

Speciaalstaal, kop gepolijst en gelakt, knipt harde draad (pianodraad).

Pince coupante diagonales

Acier spécial, tête chromée et laquée, pour fil dur (corde à piano).

Alicate cortalambr

Acero especial, Cabeza amolada y barnizada, cortante para alambre cuerda de piano.



Bestell-No./Order-No.	Art. No.	CLD mm	g	
50812121842	5081212	180	255	1

5081213

DIN ISO 5749

Seitenschneider, schwedische Form

Kopf geschliffen und lackiert, Schneide für mittelharten Draht.

Diagonal cutting nipper, swedish pattern

Head ground and lacquered, cutting edges for middlehard wire.

Zijsnijtang, zweeds model

Kop gepolijst en gelakt, knipt middelharde draad.

Pinces coupante diagonales modèle suédois

Tête chromée et laquée, pour fil de dureté moyenne.

Alicate cortalambr modelo sueco

Cabeza amolada y barnizada, cortante para alambre semi-duro.



Bestell-No./Order-No.	Art. No.	CLD mm	g	
50812131642	5081213	160	220	1

5081241

DIN ISO 9242A

Kneif-/Rabitzzange

Mattschwarz lackiert mit polierten Backen, tauchisoliert, Schneide für mittelharten Draht.

Tower pincers

Satin black lacquered finish with polished jaws, plastic coated handles.

Moniertang

Matzwart gelakt met gepolijste bekken, dompelisolatie.

Tenaille

Laquée noir mat avec becs polis, poignées isolées.

Tenaza rusa

Pintada en negro mate, bocas pulidas, mangos plastificados.



Bestell-No./Order-No.	Art. No.	CLD mm	g	
50812412213	5081241	230	330	1
50812412513	5081241	250	410	1

5081242
DIN 5241

Kantenzange

Mattschwarz lackiert
mit polierten Backen, tauchisoliert.

End cutting plier

Satin black lacquered finish with
polished jaws, plastic coated handles.

Nijptang

Matzwart gelakt
met gepolijste bekken, dompelisolatie.

Tenaille de menuisier

Laquée noir mat
avec becs polis, poignées isolées.

Tenaza de corte frontal

Pintada en negro mate,
bocas pulidas, mangos plastificados.



Bestell-No./Order-No.	Art. No.	CLD mm		
50812422013	5081242	200	430	10

50812501750

4-tlg./pcs./-dlg./pces./pzs.



Montagezangen-Satz

Chrom-Vanadium, vernickelt. Griffe kunststoffbeschichtet, gerade und abgewinkelt, für Innen- und Außensicherungen, Zangenspitze Ø 2,0 mm.

Circlip plier set

Chrome-Vanadium steel, nickel plated, non-slip cushion grip handles, straight and bent tips, for internal and external circlips, pliers tip Ø 2,0 mm.

Borgringtangenset

Chroom-Vanadium, vernikkeld. Greep met dompelisolatie. Rech en haaks, voor binnen- en buitenborgringen. Punt Ø 2,0 mm.

Jeu de pinces circlip

Chrome-Vanadium nickelé. Poignées revêtues. Droites et courbées, pour les circlip internes et externes. Pointes Ø 2,0 mm.

Juego de alicates de montaje

Cromo vanadio, niquelado. Mangos recubiertos de plástico, rectas y en ángulo para anillos de seguridad internos y externos. Punta del alicate Ø 2,0 mm.



In stabiler Kunststoffmappe.
Solid vinyl wallet.

Bestell-No./Order-No.		CLD mm	Maße · Dimensions		
50812501750	6 - 35 mm	175	200 x 150 x 40 mm	760	1

5081670

Profi Universal-Schere

Edelstahl Klingen mit feinsten Sägezahnprofilierung für hohe Standzeiten und beste Schneideergebnisse, einhändige Verriegelung.

Professional universal scissors

Stainless steel blades with finest saw tooth tread design for high durability and best cutting results, single-handed locking.

Professionele universeelschaar

RVS bek met zeer fijne vertanding voor hoge standtijd en beter snijresultaat, eenhands vergrendeling.

Ciseaux universels professionnels

Lame en acier inoxydable avec dents de scie très fine pour une longue vie et meilleurs résultats de coupe, blocage d'une seule main.

Tijera universal profesional

Hojas de acero inoxidable con perfil dentado para alta resistencia y perfectos cortes, bloqueo a una sola mano.

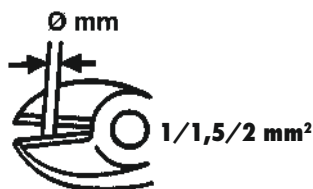

Ergonomischer 2-K Griff.
Ergonomic 2-K handle.

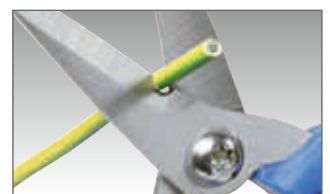

Bestell-No./Order-No.	Art. No.	CLD mm		
50816700800	5081670	200	180	1

5081259

Multifunktionszange

2-K-Griff aus hochwertigem Luffahrt-Aluminium mit Kunststoffeinlage, Flachrundzange, Standardzange, Drahtschneider, Säge, Dosenöffner, kleiner Schraubendreher, Kreuzschlitz-Schraubendreher, Messer, Feile mit Schraubendreher, Fischentschupper, Hakenlöser, Flaschenöffner.

Multifunction plier

With 2-K handle, made of high grade aircraft aluminium with plastic inlay. Long nose plier. Standard plier. Wire cutter. Saw. Can opener. Mini-screwdriver. Philips Screwdriver. Knife, File with screwdriver. Fish scaler with ruler. Hook remover. Bottle opener.

Mini Multitool

Met 2 componentengreep uit hoogwaardig luchtvaartaluminium met kunststof inleg. Telefoon tang. Draadknipper. Zaag. Blikopener. Schroevendraaier voor zaagsnede. Kruikschroevendraaier. Mes. Vijl. Gekarteld mes. Flesopener.

Pince multifonction

Avec poignée en 2K, fabriqué en aluminium de haute qualité aéronautique et avec insert en plastique. Pince à bec demi rond. Pince universelle à béc demi-ronds. Coupe fil. Scie. Ouvre-boîte. Petit-tournevis. Tournevis Philips. Couteau. Lime avec tournevis. Ecaillage à poisson. Dégorgeoir. Ouvre bouteille.

Alicate multiusos

De aluminio aeronáutico de gran calidad, con injerto de plástico y fundas de plástico 2-K. Alicata de radio. Alicata universal. Cortalambres. Sierra. Abrelatas. Mini-destornillador. Destornillador Phillips. Navaja. Lima con destornillador. Limpiaescamas. Extractor de anzuelo. Abridor de botella.

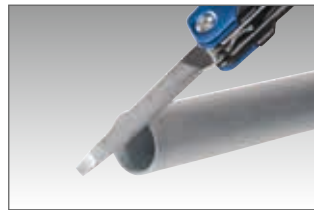
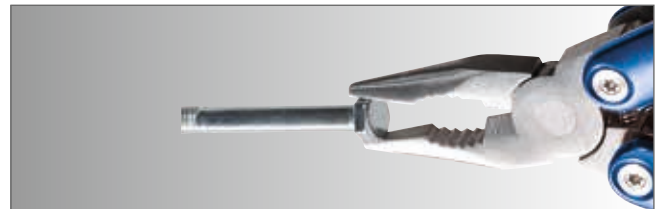
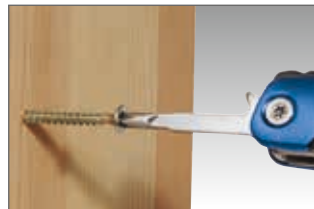

Bestell-No./Order-No.	Art. No.	CLD mm	g	mm
50812590000	5081259	160	180	1
* 50812591200	5081259-12	160	2160	1

*Lieferung im Verkaufdisplay • Delivery in sale display

5081259-1

Multifunktionszange mit Gürteltasche

Multifunction plier with belt pouch

Mini multitool met riemtas

Pince multi usage avec sac de ceinture

Alicata multiuso con cinturón portaherramientas



Bestell-No./Order-No.	Art. No.	CLD mm	g	mm
50812590100	5081259-1	160	195	1

Lieferung in Blisterverpackung / Supplied in blister packing

5081280

Gripzange

Lösehebel mit Kunststoffhülle.

Grip pliers

Plastic coated release lever.

Griptang

Ontspanhendel met kunststof overtrokken.

Pince-étai

Levier de déclenchement gainé plastique.

Tanazas grip

Palanca de desbloqueo con funda de plástico.

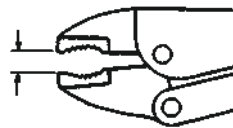

max. 45 mm



Bestell-No./Order-No.	Art. No.	CLD mm			
50812802550	5081280	235	440	1	

5081621-1

Hebelblechschere, gerade und rechtsschneidend

Geschmiedete Schneiden aus Chrom-Vanadium, gezahnt, Kunststoffhüllen mit Gleitschutz.

Lever plate shear,
straight, right hand cutting

Forged Chrome-Vanadium cutting edges,
gogged, plastic handle with slip guard.

Blikschaar, recht, rechts

Gesmede bekken van Chrom-Vanadium,
getand, kunststof grepen met anti-slip.

Cisailles à tôle démultipliées
chantourneuse à droite

Tranchant forgé en Chrome-Vanadium,
denté, gaines plastique avec protection
antifidérapante.

Tijeras cortachapas corte recto
y a derecha

Cortantes forjados de acero al Cromo
Vanadio, dentadas, fundas de plástico
con tope protejamosos.



Bestell-No./Order-No.	Art. No.	CLD mm			
50816210132	5081621-1	260	490	1	

5081647-35

Schlauchschneidezange

Zum einfachen Schneiden und Durchtrennen von Schläuchen aus PVC und Gummi. Griff mit PVC-Isolierung für optimale Handhabung.

Hose cutting pliers

For cutting and separating of PVC- and
rubber-tubes. Handle with PVC insulation
for optimum handling.

Slangknipper

Voor het eenvoudig en recht snijden van
slangen van PVC en rubber. Greep met
PVC-isolatie voor stevige grip.

Pince coupe tuyau

Pour couper et diviser facilement des
tubes en PVC et caoutchouc. Poignée
avec isolation PVC pour une manipulation
optimale.

Tenaza cortamangueras

Para cortar toda clase de mangueras de
PVC y goma. Mangos recubiertos de PVC
para un óptimo manejo.



Ø 6-35 mm



Doppelte Standzeit/Lebensdauer, aufgrund von
Doppelklingenfunktion, Halterung lösen und
Klinge um 90° drehen.

Double life cycle, because of double blade
function, remove the bracket and rotate the
blade by 90 degrees.



Bestell-No./Order-No.	Art. No.	CLD mm			
50816473500	5081647-35	255	440	1	
* 50816470000	5081647		20	1	

*Ersatzmesser • Spare blade



7 KAPITEL CHAPTER

HÄMMER, MEISSEL UND KÖRNER

HAMMERS, CHISELS AND PUNCHES

MESSEN, VIJLEN EN ZAGEN

COUTEAUX, LIMES ET SCIES

CUCHILLOS, LIMAS Y SIERRAS

- Fibreglasstiel mit Kunststoff-Schutzüberzug, Kopf schwarz lackiert
- Fibreglass handle with plastic coating, black lacquered head
- Glasfiber steel met kunststof mantel, kop zwart gelakt
- Manche en fibre de verre avec protection plastique, tête laquée noir
- Mango de fibra de vidrio plastificado, cabeza pintada de negro



5081523 - 5081525

Schlosserhämmer

Engineers' hammers

Bankhamers

Marteaux de mécanicien

Martillos de peña

Bestell-No./Order-No.	Art. No.	g	mm		
50815230021	5081523	300	315	500	5
50815250021	5081525	500	340	700	5
NEW 50815280021	5081528	800	355	1050	5

5081518

Fäustel

Club hammer

Vuisthamer

Massette

Maza



Bestell-No./Order-No.	Art. No.	g	mm		
50815181021	5081518	1000	260	1270	1

50815180000

Gummiaufsatz für Fäustel

Für Fäustel No. 50815181021

Rubber attachment for club hammer

For club hammer No. 50815181021

Rubberen dop voor vuisthamer

Voor vuisthamer no. 50815181021

Embout en caoutchouc pour massette

Pour massette No. 50815181021

Accesorio de goma para mazo

Para el mazo n° 50815181021

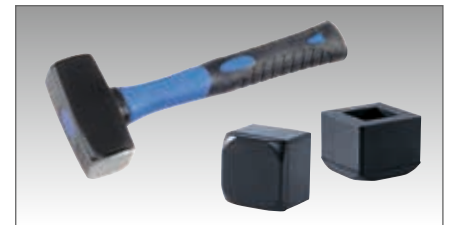

Bestell-No./Order-No.	g	Maße · Dimensions		
50815180000	1000	70 x 70 x 60 mm	430	1

50815182021

Pflasterhammer

Fäustel inkl. Gummiaufsatz.

Paving hammer

Paving hammer with rubber cap.

Vuisthamer

Vuisthamer met rubberen dop.

Massette à paver

Massette et embout en caoutchouc.

Mazo de pavimentación

Mazo incl. accesorio de goma.

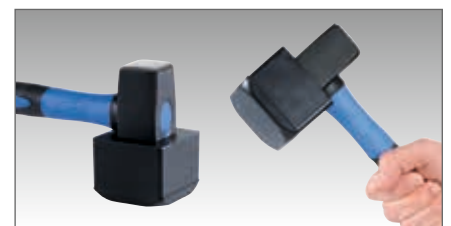

Bestell-No./Order-No.	g	mm	Maße · Dimensions		
50815182021	1000	270	270 x 120 x 72 mm	1700	1

5081516-1

Latthammer

Kopf schwarz lackiert, mit kariert-gefräster Bahn, eingeschmiedetes Nagelbett mit Magnethalterung, 2-K Kunststoffgriff.

Carpenter hammer

Head black lacquered, with chequered-milled face, with magnetic nail holder, 2-component plastic handle.

Lattenhamer

Met zwart gelakte, geribbelde kop, ingesmede magnetische spijkerhouder, 2 componenten kunststof greep.

Marteau de charpentier

Tête laquée noire, avec face fraisée en gaufrage, glissière pour clou incorporée et forgée, avec maintien magnétique, poignée antidérapante.

Martillo de carpintero

Cabezal negro lacado, con cara grafilada, canal imantado de sujeción de clavos, mango de plástico de dos componentes.



Bestell-No./Order-No.	Art. No.	 g	 mm		
50815160120	5081516-1	600	315	841	1

5081516

Ganzstahl-Latthammer

Mit kariert-gefräster Bahn, eingeschmiedetes Nagelbett mit Magnethalterung, 2-K Kunststoffgriff, Kunststoffschutzkappe an der Pinne.

Whole steel carpenter hammer

With draughted milled face, built-in forged magnetic nail holder slider, 2-components plastic handle, peen protected with a plastic sleeve.

Geheel stalen lattenhamer

Met geribbelde kop, ingesmede magnetische spijkerhouder, 2 componenten kunststof greep, kunststof beschermkap op de pinne.

Marteau de charpentier tout acier

Avec face fraisée en gaufrage, glissière pour clou incorporée et forgée avec maintien magnétique, poignée à 2 composants, pointe protégée par un manchon en plastique.

Martillo de carpintero, enteramente de acero

Con cara grafilada, canal imantado de sujeción de clavos, mango de plástico de dos componentes, funda de protección de plástico para la uña.



Bestell-No./Order-No.	Art. No.	 g	 mm		
50815160021	5081516	600	330	925	1

5081530

Shore D 66±5
Shore D 45±5

Kunststoff-Schonhammer

Hickory-Stiel, auswechselbare Köpfe in 2 Härten.

Plastic hammers

Hickory handle, exchangeable heads in 2 hardnesses.

Kunststof hamer

Hickory steel, verwisselbare koppen in 2 hardheden.

Massettes avec embouts en plastique

Poignée hickory, tête interchangeable en 2 duretés.

Martillos con bocas de plástico

Mango Hickory, cabezas intercambiables en dos durezas.



Bestell-No./Order-No.	Art. No.	∅	CLD mm		
50815302700	5081530-27	27	270	278	2
50815303500	5081530-35	35	300	390	2

5081531

Shore D 66±5

Ersatzköpfe Kunststoff

Standardmäßig aus Kunststoff (Celluloseacetat) für Kunststoff-Schonhammer, Härte nach Shore D 66±5.

Plastic spare heads

Standard, made of plastic (cellulose acetate) for plastic hammers, hardness according to Shore D 66±5.

Reservedoppen uit kunststof

Standaard, uit kunststof (cellulose-acetaat) voor kunststof hamers, hardheid volgens Shore D 66±5.

Embouts de rechange en plastique

Standard, en plastique (acétocellulose) pour massettes, Shore D 66±5.

Bocas de recambio de plástico

Estándar, de plástico (acetato de celulosa) para martillos con bocas de plástico, Shore D 66±5.



Bestell-No./Order-No.	Art. No.	∅		
50815312700	5081531-27	27	18	10
50815313500	5081531-35	35	23	10

5081532

Shore D 45±5

Ersatzköpfe Nylon

Standardmäßig aus schlagfestem Nylon, Härte nach Shore D 45±5.

Spare nylon heads

Standard, made of nylon, hardness complying with Shore D 45±5.

Reservedoppen nylon

Standaard, uit slagvast nylon, hardheid volgens Shore D 45±5.

Embouts de nylon interchangeables

Standard, en nylon, Shore D 45±5.

Bocas de nylon, de recambio

Estándar con bocas de nylon, Shore D 45±5.



Bestell-No./Order-No.	Art. No.	∅		
50815322700	5081532-27	27	12	10
50815323500	5081532-35	35	23	10

5081440

Werkzeugsatz mit Meißel, Körner, Splint- und Durchtreiber

In klappbarer Metallkassette.







Chisel and pin punch set
In hinged metal box.

Gereedschapset met beitels, centerpunt, pendrijver en doorslagen
In metalen cassette.

Composition de burins, bédanes et chasse-goupille
En boîte métallique, repliable.

Conjunto de herramientas compuesto de cortafíos, granetes y punzones cilíndricos
En caja metálica plegable.



Bestell-No./Order-No.	Art. No.	enthaltend · containing			
50814400000	5081440	1	 Ø 3 x 120 mm	715	1
		1	 Ø 5 x 150 mm		
		1	 Ø 3 x 120 mm		
		1	 5 x 130 mm		
		2	 12 x 130 mm 14 x 150 mm		

50830

Splinttreibersatz

In klappbarer Metallkassette.



Pin punches set
In hinged metal box.

Pendrijverset
In metalen cassette.

Jeu de chasses-goupilles
En boîte métallique, repliable.

Juego de punzones cilíndricos
En caja metálica plegable.



Bestell-No./Order-No.	Art. No.	enthaltend · containing			
50830000000	50830	6	 Ø 3 / 4 / 5 / 6 / 7 / 8 x 150 mm	690	1



8 KAPITEL CHAPTER

SCHRAUBENDREHER
STIFTSCHLÜSSEL
STECKSCHLÜSSEL

SCREWDRIVERS
PIN WRENCHES
NUT SPINNER

SCHROEVENDRAAIERS
STIFTSLEUTELS
DOPSCHROEVENDRAAIERS

TOURNEVIS
CLÉ À ERGOTS
CLÉ À DOUILLE

DESTORNILLADORES
LLAVES DE ESPIGA
LLAVES DE VASO

50834

5/32"

31-tlg./pcs./dlg./pces./pzs.

Feinmechaniker-Bitsatz

Chrom-Vanadium, verchromt,
in Kunststoffbox. 5/32" Aufnahme.

Precision bit-set

Chrome-Vanadium, chromium plated,
in plastic box. 5/32".

Precisie bitset

Chroom-Vanadium, verchromd,
in kunststof koffer. 5/32".

Embouts de précision

Chrome-Vanadium, chromés,
en coffret plastique, entraînement 5/32".

Juego brocas - Mecánico de precisión

Cromo Vanadio, cromadas,
en caja de plástico. 5/32".



enthaltend/containing

144 mm / 5/32"

PH 000 / 00 / 0 / 1

PZ 0 / 1

0,7 / 0,9 / 1,3 / 1,5 / 2 / 2,5 / 3 / 4

1 / 1,5 / 2 / 2,5 / 3 / 3,5 / 4

TX 4 / 5 / 6 / 7 / 8 / 9 / 10 / 15 / 20

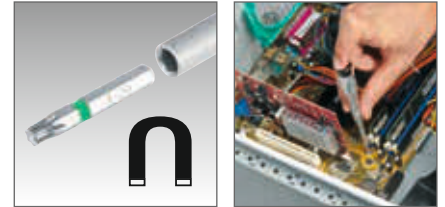

Bestell-No./Order-No.	Art. No.	Maße - Dimensions	g	
5083400000	50834	155 x 105 x 40 mm	396	1

5/32"

Ersatzteile

Spare parts

Onderdelen

Pièces de rechange

Piezas de repuesto



50834-32



50834-35



50834-31



50834-30

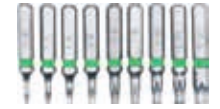

50834-37

Bestell-No./Order-No.	Art. No.	Maße - Dimensions	g	
50834000100	50834-1	144 mm / 5/32"	47	1
50834320400	50834-32	PH 000/00/0/1	16	1
50834350200	50834-35	PZ 0/1	5	1
50834310800	50834-31	0,7/0,9/1,3/1,5/2/2,5/3/4	41	1
50834300700	50834-30	1/1,5/2/2,5/3/3,5/4	10	1
50834370900	50834-37	TX 4/5/6/7/8/9/10/15/20	21	1

50835

DIN 5265 / 8764

16-tlg./pcs./dlg./pces./pzs.

Feinmechaniker-

Schraubendrehersatz

Ergonomischer 2-K Softgriff mit drehbarer
Kappe. Klingen aus Chrom-Molybdän-
Stahl, gehärtet und geschwärzt.

Precision screwdriver set

2-K Screwdriver. Ergonomic soft grip
with rotatable cap. Blades made of
chrom-molybdenum steel, hardened, with
black tip.

Precisie schroeven-draaierset

Ergonomische 2-K softgriep met
draaibare kap. Klingen uit chroom-
molybdeen staal, gehard en gezwart.

Jeu de tournevis de mécanicien de précision

Tournevis 2 composants. Manche
softgripp ergonomique avec embout
rotatif. Lames acier Chrom-Molybdène
trempés et noirci.

Juego de destornilladores para mecánico

En bolsa enrollable, destornillador con
mango de dos componentes. Mango
ergonómico con tope giratorio. Hojas de
acero al cromo molibdeno, templadas y
fosfatadas.



enthaltend/containing

PH 000 / 00 / 0

0,9 / 1,5 / 2 / 2,5 / 3

1,5 / 2 / 2,5

TX 4 / 5 / 6 / 7 / 8



In Rolltasche. In wallet.

Bestell-No./Order-No.	Art. No.	Maße - Dimensions	g	
50835000000	50835	230 x 115 x 50 mm	420	1

DIN 5265 / 8764

- Ergonomischer 2-K Softgriff. Klinge aus Chrom-Molybdän-Stahl, gehärtet und geschwärzt.
- With ergonomic 2 components soft grip plastic handle, blades from chrom-molybdenum steel, hardenend, with black tip.
- Ergonomische 2-K softgreep, kling uit chroom-molybdeenstaal, gehard en gezwart.
- Tournevis à poignée ergonomique bimatière, lame en chrome-molybdène, trempée, et bout bruni.
- Destornilladores según mango ergonómico de dos componentes varillas de acero al cromo molib-deno, templadas y pavonadas.



148



5084511 - 5084530

2-K Werkstatt-Schraubendreher
Workshop screwdrivers
2 Componenten werkplaats schroevendraaier
Tournevis
Destornilladores de taller



Bestell-No./Order-No.	Art. No.	Tip	Weight	Length
50845110180	5084511	PH 1	60	10
50845110280	5084511	PH 2	100	10
50845120180	5084512	PZ 1	60	10
50845120280	5084512	PZ 2	100	10
50845300480	5084530	0,8 x 4,0 x 75 mm	40	10
50845305580	5084530	1,0 x 5,5 x 125 mm	80	5
50845306580	5084530	1,2 x 6,5 x 150 mm	100	5

5084564

5-tlg./pcs./-dlg./pces./pzs.

2-K Werkstatt-Schraubendreher-Satz

Workshop screwdrivers set
2 Componenten werkplaats schroevendraaier-set
Jeu de Tournevis
Destornilladores de taller



Bestell-No./Order-No.	Art. No.	Tip	Weight	Length
50845640080	5084564	0,8 x 4,0 x 75 mm, 1,0 x 5,5 x 125 mm, 1,2 x 6,5 x 150 mm + PH 1, PH 2	460	1

5084515

TORX®-Schraubendreher
TORX®-Screwdrivers
TORX® schroevendraaier
TORX®-Tournevis
TORX®-Destornilladores



Bestell-No./Order-No.	Art. No.	Tip	Weight	Length
50845151080	5084515	T 10	63	10
50845151580	5084515	T 15	63	10
50845152080	5084515	T 20	63	10
50845152580	5084515	T 25	87	5
50845152780	5084515	T 27	87	5
50845153080	5084515	T 30	87	5
50845154080	5084515	T 40	97	5

5084560

7-tlg./pcs./-dlg./pces./pzs.

TORX®-Schraubendreher-Satz
Set of TORX®-Screwdrivers
TORX® schroevendraaier-set
Jeu de tournevis TORX®
Juego de destornilladores TORX®



Bestell-No./Order-No.	Art. No.	Tip	Weight	Length
50845600080	5084560	T 10 / T 15 / T 20 / T 25 / T 27 / T 30 / T 40	680	1

5083301-1

Magnet Bithalter

Chrom-Molybdän, verchromt. Mit 2-K Kunststoffgriff. Mit Dauermagnet. Extrem schmale Ausführung.

Magnetic bitholder

Chrom-molybdenum, chromium. With ergonomic 2-K plastic handle. With permanent magnet. Extremely slim shape.

Bitadapter

Chroom-molybdeenstaal, verchromd. Met permanente magneet. Extrem smalle uitvoering.

Poignée porte-embouts magnétique

Chrom-molybdène, chromé. Avec poignée ergonomique souple à 2 composantes. Aimant permanent. Tête ultra mince.

Adaptador de puntas

Cromo molibdeno, cromadas. Mango plástico ergonómico 2 componentes. Con imán permanente. Diseño extremadamente delgado.



Sicherheitsarretierung durch Dauermagnet und formschlüssige Arretierung. Einfache Entnahme durch Auswurfbetätigung. Ideal geeignet für enge, schwer zugängliche Stellen.
Safety locking by permanent magnet and positive locking. Easy removal by actuating the ejection. Best suited for tight places with difficult access.

Bestell-No./Order-No.	Art. No.	CL mm	g	mm
50833010080	5083301-1	200	240	1

5080542

Steckschlüssel

Mit Quergriff und Aufhängebohrung, für Aussensechskantschrauben, Spezial Stahl.

Nut spinner

With T-handle and hang-up hole for hexagon socket screws, special steel.

Dopschroevendraaier

Met T-greep en ophangoog, voor zeskantbouten, speciaal staal.

Tournevis en T à douille

Poignée ergonomique à 2 composants, lame en acier spécial.

llaves de vaso

Con mango transversal con agujero, para tuercas y tornillos de cabeza exagonal, acero especial.

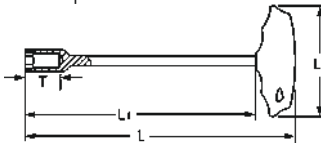

Bestell-No./Order-No.	MM	CL mm	L1 mm	L2 mm	T mm	g	mm
50805425580	5,5	260	230	95	21,0	104	5
50805420680	6	260	230	95	21,0	106	5
50805420780	7	260	230	95	21,0	107	5
50805420880	8	270	230	115	26,0	236	5
50805420980	9	270	230	115	26,0	240	5
50805421080	10	270	230	115	26,0	242	5
50805421180	11	270	230	115	26,0	248	5
50805421280	12	270	230	115	26,0	252	5
50805421380	13	270	230	115	26,0	262	5

R 5080542-9

9-tlg./pcs./-dlg./pces./pzs.

Steckschlüsselsatz

In Polyesterrolltasche, mit Textilbindeschleifen und Aufhängeösen.

Nut spinner set

Polyester wallet with textile strap and suspension eyelet.

Dopschroevendraaierset

In polyester roltaas, met sluitriemen en ophangogen.

Jeu de tournevis en T à douilles

Trousse en polyester avec lanière textile et œillet de suspension.

Juego de llaves de vaso con mango

En bolsa enrollable de poliestireno, con cintas de cierre y ojal para colgar.



Bestell-No./Order-No.	Art. No.	enthaltend · containing	g	mm
* 50805429080	R 5080542-9	MM 5,5/6/7/8/9/10/11/12/13	2635	1

* Auslauf / Discontinued

- Spezial Stahl
- Special steel
- Special steel
- Acier spécial
- Acero especial



5081338

Sechskant-Schraubendreher

Mit Quergriff und Aufhängebohrung, für Innensechskant-schrauben.

Hexagonal head wrench

With T-handle and hang-up hole for hexagon socket screws.

Stiftsleutel zeskant

Met T-greep en ophangoog, voor binnenzeskantbouten.

Tournevis hexagonal

Avec poignées en T et trou de suspension pour vis hexagonales.

Destornilladores exagonales

Con mango transversal con agujero, para tornillos y tuercas de cabeza exagonal.

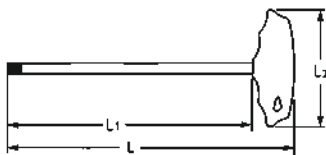

Bestell-No./Order-No.	MM	CLD mm	L1 mm	L2 mm	g	pcs
50813380280	2	130	100	75	19	5
50813382580	2,5	130	100	75	21	5
50813380380	3	130	100	75	23	5
50813380480	4	180	150	75	35	5
50813380580	5	180	150	95	65	5
50813380680	6	185	150	95	79	5
50813380880	8	230	200	95	135	5
50813381080	10	240	200	115	225	5

H 5081338-8

8-tlg./pcs./-dlg./pces./pzs.



Sechskant-Schraubendrehersatz

Mit Aufhängebohrungen.

Set of hexagonal head wrenches

With hang-up hole.

Stiftsleutelset zeskant met T-greep

Met ophangogen.

Jeu de tournevis hexagonaux

Avec trou de suspension.

Juego de destornilladores exagonales

Con agujeros para colgar.

Im Metallhalter
In metal holder
170 x 120 x 245 mm



Bestell-No./Order-No.	Art. No.	MM	g	pcs
50813380080	H 5081338-8	2/2,5/3/4/5/6/8/10	920	1

H 5081340-7

Winkelschraubendrehersatz

Im Handklapphalter, kunststoffbeschichtet, für Innensechskantschrauben.

Set of hexagonal head wrenches

In metal holder, plastic coated for hexagon socket screws.

Stiftsleutelset

Zakmesmodel, kunststof houder, voor binnenzeskant bouten.

Jeu de clés mâles

Sur montage, revêtement plastique, pour vis à pans creux.

Juego de llaves Allen

En soporte plegable, plastificadas, para tornillos Allen interiores.



Lieferung in Blisterverpackung.
Supplied in blister packing.



Bestell-No./Order-No.	Art. No.	MM	g	pcs
50813406280	5081340-7	1,5/2/2,5/3/4/5/6	134	5

- Spezial Stahl
- Special steel
- Special staal
- Acier spécial
- Acero especial

HP 5081343-9

9-tlg./pcs./-dlg./pces./pzs.

Kugelpf-Winkelschrauben-drehersatz

Im Kunststoffhalter, für schwer zugängliche Innensechskantschrauben.

Set of ball head hexagonal wrenches

In plastic holder for hexagon socket screws in confined or hard to reach areas.

Stiftsleutelset kogelkop

In kunststof houder, voor moeilijk bereikbare binnen-zeskant bouten.

Jeu de clés mâles coudées à tête sphérique

Sur monture plastique, pour vis 6 pans creux avec accès difficile.

Juego de llaves Allen con cabeza esférica

En soporte de plástico, para tornillos Allen interiores de difícil acceso.

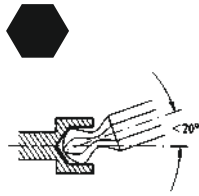

Lieferung in Blisterverpackung.
Supplied in blister packing.

Bestell-No./Order-No.	Art. No.	 mm	CL mm	 g	
50813438280	HP 5081343-9	1,5/2/2,5/3/4/5/6/8/10	185	353	5

HP 5081344-9

9-tlg./pcs./-dlg./pces./pzs.

Kugelpf-Winkelschrauben-drehersatz, lang

Set of ball head hexagonal wrenches, long

Stiftsleutelset kogelkop, lang

Jeu de clés mâles coudées à tête sphérique, long

Juego de llaves Allen con cabeza esférica, largo

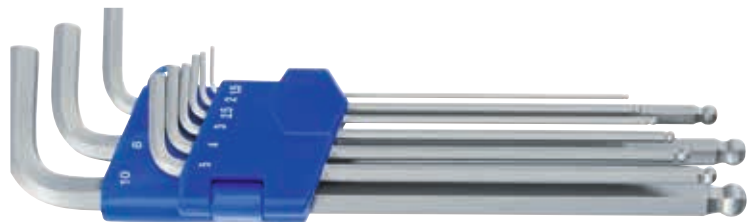

Lieferung in Blisterverpackung.
Supplied in blister packing.

Bestell-No./Order-No.	Art. No.	 mm	CL mm	 g	
50813448280	HP 5081344-9	1,5/2/2,5/3/4/5/6/8/10	235	470	5

5081347

TORX®-Schraubendreher

Mit Quergriff und Aufhängebohrung, für Innen-TORX®-Schrauben.

TORX®-Screwdrivers

With T-handle and hang-up hole for TORX® socket screws.

TORX® schroevendraaier

Met T-greep en ophangoog voor binnen TORX® bouten.





Tournevis TORX®

Avec poignées en T et trou de suspension pour vis TORX® intérieures.

Destornilladores TORX®

Con mango transversal con agujero para colgar, para tornillos TORX® interiores.



Bestell-No./Order-No.		 mm	CL mm	L1 mm	L2 mm	 g	
50813471080	T 10	2,74	125	100	75	27	5
50813471580	T 15	3,27	125	100	75	28	5
50813472080	T 20	3,86	125	100	75	28	5
50813472580	T 25	4,43	130	100	95	62	5
50813472780	T 27	4,99	130	100	95	63	5
50813473080	T 30	5,52	235	200	95	85	5
50813474080	T 40	6,65	235	200	95	123	5
50813474580	T 45	7,82	285	250	95	142	5
50813475080	T 50	8,83	290	250	115	315	5

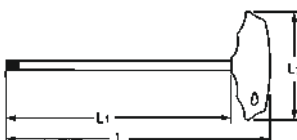

- Spezial Stahl
- Special steel
- Special staal
- Acier spécial
- Acero especial

H 5081347-9

9-tlg./pcs./dlg./pces./pzs.



TORX®-Schraubendrehersatz

Mit Aufhängebohrungen.

Set of TORX®-Screwdrivers
With hang-up hole.

TORX® schroevendraaier-set
met T-greep
Met ophangogen.

Jeu de tournevis TORX®
Avec trou de suspension.

Juego de destornilladores
TORX®
Con agujeros para colgar.



Im Metallhalter
In metal holder
195 x 120 x 290 mm

Bestell-No./Order-No.	Art. No.			
50813470080	5081347-9	T 10/T 15/T 20/T 25/T 27 T 30/T 40/T 45/T 50	1245	1

H 5081348-7



TORX®-Winkelschraubendrehersatz

Im Handklapphalter, kunststoffbeschichtet,
für Innen-TORX®-Schrauben.

Set of L-shaped TORX®
Wrenches

In metal holder, plastic coated
for TORX® socket screws.

TORX® schroevendraaier-set
Zakmesmodel, kunststof houder,
voor binnen TORX® bouten.

Jeu de tournevis TORX®
Sur montage, revêtement plastique,
pour vis TORX® intérieures.

Juego de destornilladores
TORX®

En soporte plegable, plastificadas,
para tornillos TORX® interiores.



Lieferung in Blisterverpackung.
Supplied in blister packing.

Bestell-No./Order-No.	Art. No.			
50813486280	5081348-7	T 10/T 15/T 20/T 25/T 27/T 30/T 40	245	1

HP 5081348-9

9-tlg./pcs./-dlg./pces./pzs.



TORX®-Winkelschraubendrehersatz

Im Kunststoffhalter.

Set of L-shaped TORX®-Wrenches

In plastic holder.

TORX® schroevendraaier-set

In kunststof houder.

Jeu de tournevis TORX® coudés

Sur monture plastique.

Juego de destornilladores TORX®

En soporte de plástico.

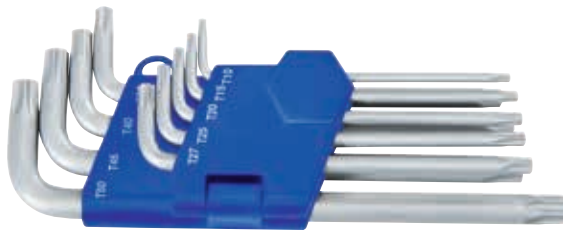

Lieferung in Blisterverpackung.
Supplied in blister packing.

Bestell-No./Order-No.	Art. No.		mm	g	
50813488280	5081348-9	T 10/T 15/T 20/T 25/T 27 T 30/T 40/T 45/T 50	160	316	1

HP 5081349-9

9-tlg./pcs./-dlg./pces./pzs.



TORX®-Winkelschraubendrehersatz, lang

Set of L-shaped TORX®-Wrenches, long

TORX® schroevendraaier-set,

lang

Jeu de tournevis TORX® coudés,

long

Juego de destornilladores TORX®, largo

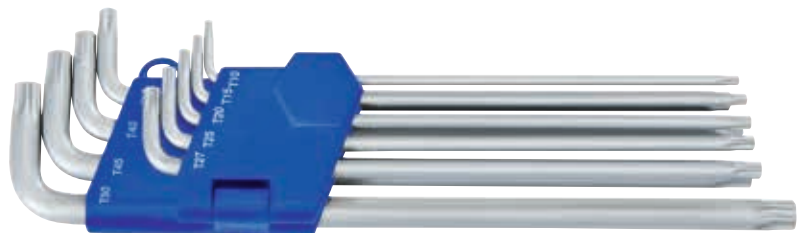

Lieferung in Blisterverpackung.
Supplied in blister packing.

Bestell-No./Order-No.	Art. No.		mm	g	
50813498280	5081349-9	T 10/T 15/T 20/T 25/T 27 T 30/T 40/T 45/T 50	235	480	1

50899000560

DIN 22417

Dreikant-Steckschlüssel, M5

Aus nahtlos kaltgezogenem Präzisionsstahlrohr, mit durchgestecktem, beweglichem Quergriff, verzinkt.

Tubular triangular wrench, M5

Made of seamless, cold-drawn precision steel tube with inserted, movable handle, galvanized.

Driekant pijpsleutel, M5

Uit naadloos koud getrokken precisie stalen buis, met doorgestoken, beweegbare greep, verzinkt.

Clé triangle de sécurité, M5

En acier à tuyau sans jointure, avec poignée coulissante, galvanisée.

Llave de vaso triangular M5

De tubo de acero de precisión trefilado en frío y sin soldadura, con pasador en cruz móvil, galvanizada.



Geeignet zur Fahrstuhl-Notentriegelung.
suitable for elevator emergency unlocking.

Bestell-No./Order-No.	mm	g	
50899000560	200	55	1

50898

DIN 3222/3223



Dreikant-Rohrsteckschlüssel

Mit Drehstift, Normdreikant für M10 und M12.

Tubular triangular wrench

With tommy bar, for standard M10 and M12 triangulars.

Driekante paalsleutel

Met wringstaaf, norm driekant voor M10 en M12.

Clé en tube triangulaire

Avec broche, triangle pour M10 et M12.

Llave de tubo de boca triangular

Con bandeador, triángulo normalizado para M10 y M12.

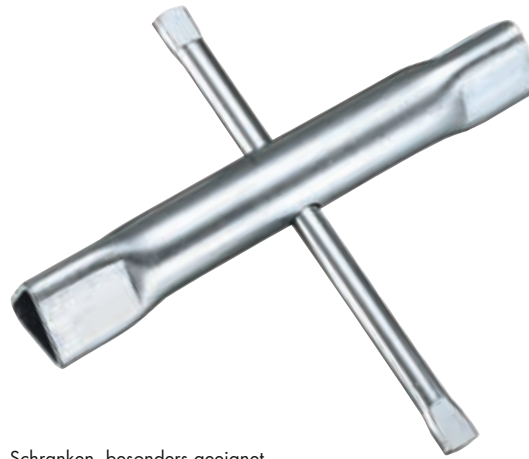

Für Absperrpoller, Schranken, besonders geeignet für Rettungskräfte, Handwerker und Hausmeister. Especially for rescue services, craftsmen and facility management applications.

Bestell-No./Order-No.	Art. No.	Ø x L mm	g	Stk
50898101260	50898	140 x 125	175	1

5081480

Architekten-Bauschlüssel

- vielseitige Einsatzmöglichkeiten egal, ob als Türöffnungswerkzeug, Schaltschrankschlüssel oder als Flaschenöffner

- ein zuverlässiger Partner auf jeder Baustelle

- hochglänzender Zinkdruckguss

Architects' Construction Key

- Versatile application possibilities whether as a door opening tool, switch cabinet key or bottle opener

- a reliable partner on every construction

- high-gloss zinc die-cast

Veelzijdige

- toepassingsmogelijkheden als gereedschap om een deur te openen

- schakelkast sleutel of als flesopener

- een betrouwbare partner op elke bouwplaats

- Hoogglanzend gegoten zink

Clé de construction architecte

- de multiples possibilités d'utilisation que ce soit comme outil d'ouverture de porte

- clé d'armoire électrique ou comme ouvre-bouteille

- un partenaire fiable sur chaque chantier

- zinc moulé sous pression ultra-brillant

Llave de construcción para arquitecto

- Versátiles posibilidades de aplicación, ya sea como herramienta de apertura de puertas, llave de armarios de distribución o abridor de botellas

- un socio fiable en cualquier construcción

- fundición inyectada de cinc de alto brillo

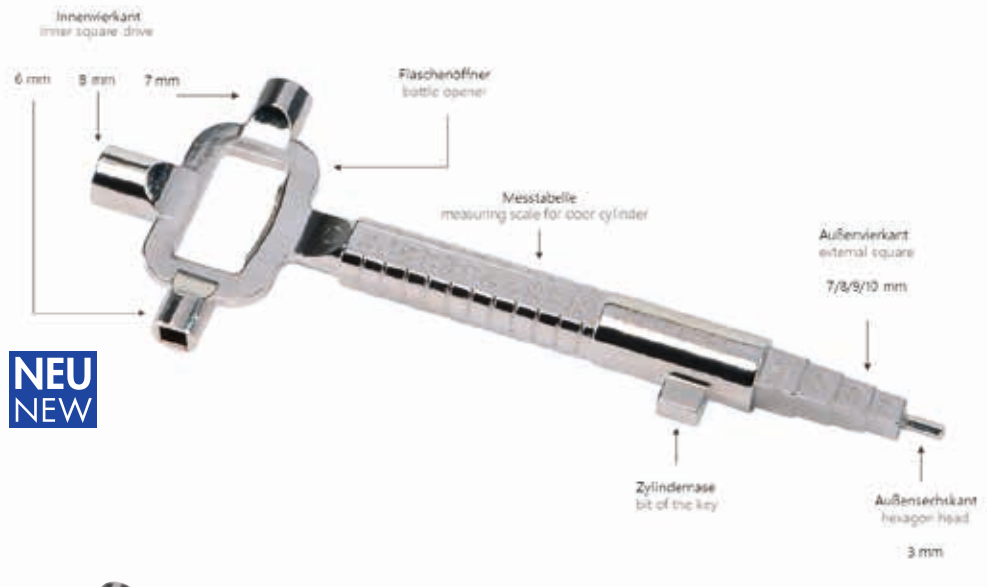

**NEU
NEW**



Bestell-No./Order-No.	6mm	7/8/9/10	6/7/8	g	Stk
50814800080	3	7/8/9/10	6/7/8	190	1



9 KAPITEL CHAPTER

BIT-SÄTZE

BIT SETS

BITSETS

JEUX D'EMBOUITS

JUEGOS DE BROCAS



Chrom-Vanadium, verchromt
 Chrome-Vanadium, chromium plated
 Chromo-Vanadium, verchromd
 Chrome-Vanadium, chromées
 Cromo Vanadio, cromadas

50833-2

Bit-Box-Satz, 32-tlg.

Chrom-Vanadium, gesandstrahlt, mit magnetischem Schnellwechseladapter und Adapter für 1/4" Vierkant-Halter, mit formschlüssiger Arretierung, mit Gürtelhalter und Bohrung für Wandaufhängung.

Bit-box-set, 32 pcs.

Chrome-Vanadium, sand blasted, with magnetic quick changing adapter for 1/4" tool-holder with belt clip and borehole for wallmounting.

Bitbox set, 32-dlg.

Chroom-Vanadium, gezandstraalt, met magnetische snelwisseladapter en adapter voor 1/4" vierkant aansluiting, met broekriemclip en ophangoog voor wandbevestiging.

Jeu d'embouts de 32 pcs.

Chrome-Vanadium, sablé, avec adaptateur magnétique à éjection rapide, et adaptateur pour porte-outil 1/4" carré avec clip pour ceinture, brocheable.

Juego de 32 puntas en caja

Cromo Vanadio, granllado, con adaptador imantado de cambio rápido, sujeción de cinturón y agujero para colgar de la pared.



- R1/R2
- 3,5/4,5/5,5/6,5/8
- PH1/PH2(2x)/PH3
- PZ1/PZ2(2x)/PZ3
- 2/3/4/5/6/7/8
- TT9/10/15/20/25/27/30/40
- 1/4"

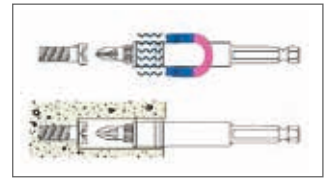

Bestell-No./Order-No.	Art. No.	Maße · Dimensions		
50833200000	50833-2	105 x 65 x 40 mm	250	1
* 50833201000	50833-2-10	105 x 65 x 40 mm	2500	10

*Lieferung im Verkaufsdisplay • Delivery in sale display

50833-3

Bit-Box-Satz, 31-tlg.

Bit-Knarre, 48 Zähne. Chrom-Vanadium, gesandstrahlt, mit Adapter für 1/4" Vierkant-Halter, mit Gürtelhalter.

Bit-box-set, 31 pcs.

Bit-Ratchet, 48 teeth. Chrome-Vanadium, sand blasted, with adapter for 1/4" tool-holder with belt clip.

Bitbox, set 31-dlg.

Ratelbithouder 48 tanden. Chroom-Vanadium, gezandstraalt met Adapter voor 1/4" vierkant aansluiting, met broekriemclip.

Jeu d'embouts de 31 pcs.

Cliquet à embouts de 48 dents. Chrome vanadium, sablé, avec adaptateur 1/4" carré, clip de ceinture.

Juego de 31 puntas en caja

Bit-carraca, 48 dientes. Cromo Vanadio, granllado, con adaptador de cambio rápido, sujeción de cinturón.



- R1/R2
- 3,5/4,5/5,5/6,5/8
- PH1/PH2(2x)/PH3
- PZ1/PZ2(2x)/PZ3
- 2/3/4/5/6/7/8
- TT9/10/15/20/25/27/30/40
- 1/4"



Bestell-No./Order-No.	Art. No.	Maße · Dimensions		
* 50833300000	50833-3	105 x 65 x 40 mm	358	1

*Auslauf / Discontinued

50833-4

Bit-Box-Satz, 33-tlg.

Chrom-Vanadium, gesandstrahlt, mit Adapter für 1/4" Sechskant-Halter, mit Gürtelhalter.

Bit-box-set, 33 pcs.

Chrome-Vanadium, sand blasted, with adapter for 1/4" tool-holder with belt clip.

Bitbox, set 33-dlg.

Chroom-Vanadium, gezandstraalt, met Adapter voor 1/4" sechskant aansluiting, met broekriemclip.

Jeu d'embouts de 33 pcs.

Chrome vanadium, sablé, avec adaptateur 1/4" carré, clip de ceinture.

Juego de 33 puntas en caja

Cromo Vanadio, granallado, con adaptador de cambio rápido, sujeción de cinturón.



- 3/4/5/5,5/6,5
- PH1/PH2(2x)/PH3
- PZ1/PZ2(2x)/PZ3
- 2/2,5/3/4/5/6
- T8/9/10/15(2x)/20(2x)/25(2x)/27/30/40
- 1/4"



Bestell-No./Order-No.	Art. No.	Maße - Dimensions		
* 50833400000	50833-4	105 x 85 x 45 mm	295	1
* 50833401200	50833-4-12	105 x 85 x 45 mm	3540	12

*Lieferung im Verkaufsdisplay • Delivery in sale display
* Auslauf / Discontinued

50833-5

Bit-Box-Satz, 32-tlg.

Chrom-Vanadium, gesandstrahlt, Mini-Bit-Knarre, 48 Zähne, magnetischer Schnellwechseladapter mit Arretierung, mit Gürtelhalter.

Bit-box-set, 32 pcs.

Chrome-Vanadium, sand blasted, Mini-Bit-Ratchet, 48 teeth, magnetic quick changing adapter, with belt clip.

Bitbox, set 32-dlg.

Chroom Vanadium, gezandstraald, mini bit ratel, 48 tands, magnetische snelwisseladapter, met riemhouder.

Jeu d'embouts de 32 pcs.

Chrome Vanadium, sablé, mini cliquet porte-embouts, 48 dents, adaptateur quick change magnétique, avec clip de ceinture.

Juego de 32 puntas en caja

Cromo-Vanadio, granallado, mini carraca, 48 dientes, adaptador imantado de cambio rápido con clip de cinturón.



- enthaltend/containing**
- 85 mm
- 95 mm
- 3,5/4,5/5,5/6,5/8
- PH1(2x)/PH2(2x)/PH3
- PZ1/PZ2(2x)/PZ3
- 2/3/4/5/6/7/8
- TT9/10/15/20/25/27/30/40
- 1/4"

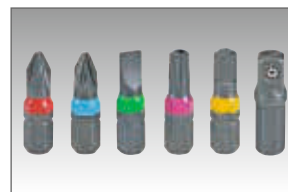

Bestell-No./Order-No.	Art. No.	Maße - Dimensions		
50833500000	50833-5	105 x 65 x 40 mm	300	1
* 50833501000		105 x 65 x 40 mm	3580	10

*Lieferung im Verkaufsdisplay • Delivery in sale display



10 KAPITEL CHAPTER

MESSER
FEILEN
SÄGEN

KNIVES
FILES
SAWS

MESSEN
VIJLEN
ZAGEN

COUTEAUX
LIMES
SCIES

CUCHILLOS
LIMAS
SIERRAS

5081675-79

Werkstattfeilen

Hieb 2, mit ergonomischem 2-K Softgriff und integrierten Aufhängeösen.

Engineers' files

With ergonomic 2-K plastic handle and integrated hanging hole for easy storage.

Werkplaatsvijlenset

Halfzoet, met ergonomische 2 componenten soft-grip en geïntegreerd ophangoog.

Limes d'atelier

Avec poignée ergonomique souple à 2 composantes et trou de suspension inclus.

Limas

Mango plástico ergonómico 2 componentes y colgador para un fácil almacenaje.



Bestell-No./Order-No.	Art. No.		CLD mm	g	
50816752000	5081675	—	200	220	1
50816762000	5081676	⤿	200	220	1
50816772000	5081677	▲	200	220	1
50816782000	5081678	■	200	220	1
50816792000	5081679	●	200	220	1

5081680

5-tlg./pcs./-dlg./pces./pzs.

Werkstattfeilen-Satz

Hieb 2, 8"/200 mm in Rolltasche mit Aufhängeösen.

Engineer files set

8"/200 mm in wallet and hanging hole.

Werkplaatsvijlenset

Halfzoet, 8"/200 mm in rolltas met ophangogen.

Jeu de limes d'atelier

8"/200 mm en trousse avec trou de suspension.

Juego de limas

8"/200 mm en bolsa enrollable con ojal para colgar.



Bestell-No./Order-No.	Art. No.	CLD mm	g	
50816800500	5081680	200	1100	1

5081668

Kabel-Klappmesser

Mit 2-K Griff, für schnelle Kabel- und Drahtabisolierung, rostfreie Klinge.

Cable folding knife

With 2-K handle, for quick stripping of cables and wires, blade of stainless steel.

Inklapbaar kabelmes

Met 2 componenten greep, voor snel kabel- en draadstrippen, rvs lemmet.

Couteau d'électricien

Bimatière, pour le dénudage rapide des fils et câbles, lame en acier inoxydable.

Navajas de electricista

Para cables con 2 mangos componentes para pelar los alambres y los cables de forma rápida, hoja de acero inoxidable.



Bestell-No./Order-No.	Art. No.	CLD mm	g	
50816680000	5081668	115 - 195	75	1

50816852000

4 in 1

4 in 1 Universal Handfeile

Als Flach- und Halbrundfeile ausgeführt. Fein- und Raspelhieb. Einfache Anwendung und Handhabung. Für Holz, Kunststoff, Metall, Horn und ähnliche Materialien.

4 in 1 Universal hand file

With flat and halfround file. Fine and rasp cut. Easy application. For wood, plastic, metal, horn and similar materials.

4 in 1 Iniversele handvijl

Als vlakke en halfronde vijl uitvoering - zoet en raspvijl - eenvoudig te gebruiken en hanteren - voor hout, kunststof, metaal, hoorn en vergelijkbare materialen.

4 in 1 Lime universelle à main

Un côté plat, un côté rond. Un côté râpe, un côté lime. Pour le bois, le plastique, le métal, et autres matériaux.

4 en 1 Lima manual universal

Corte fino y raspado. Fácil de usar y la manipulación. Para la madera, el plástico, metal, cuerno y materiales similares.

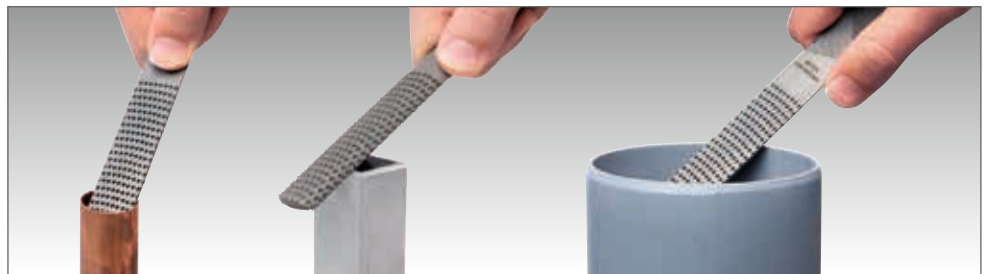
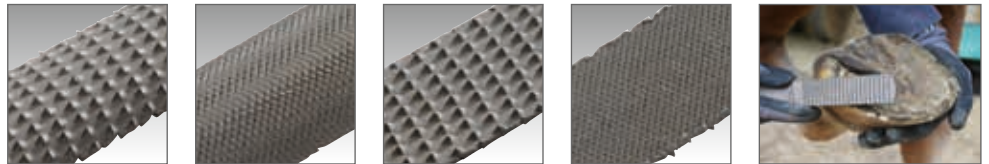

Bestell-No./Order-No.	Ø mm	Maße · Dimensions	g	1
50816852000	185	200 x 20 x 5 mm	185	1

5081669

18 mm

Cuttermesser

Aus 2-K Kunststoff, mit Feststellrad und integriertem Klingensmagazin, selbstladend, 5-fach bestückt, inkl. Klingendreher und Bleistiftanspitzer.

Utility knife

Made of 2-K plastic with integrated blade magazine, consisting of 5 pcs., inclusive breaker and sharpener.

Breekmes

Van 2 componenten kunststof, met automatische vergrendeling en geïntegreerd magazijn voor reserve messen, zelfladend, incl. 5 messen, met mesbreker en puntenslijper.

Cutter

En plástico a 2 componentes, avec chargeur de 5 lames, casse-lame et taille-crayon inclus.

Cutter

De plástico de 2 componentes con compartimento para almacenamiento de hojas, con 5 funciones, incluidas rompehojas y sacapuntas.



Bestell-No./Order-No.	Art. No.	Ø mm	g	1
50816690000	5081669	170	147	1
* 50816691200	5081669-12	170	2093	12

*Lieferung im Verkaufsdisplay • Delivery in sale display

5081611-1

Japansäge

Extra dünnes Sägeblatt - besonders geeignet für schwer zugängliche Stellen. Hochwertige SK5-Stahl Sägeblätter, Zähne induktiv gehärtet.

Japanese Saw

Extra thin blade - best suited for areas difficult to access. High grade SK5 steel blades, induction hardened teeth.

Japanse zaag

Extra dun zaagblad - uitermate geschikt voor moeilijk bereikbare plaatsen. Hoogwaardig SK5-stal zaagblad, tanden inductief gehard.

Scie japonaise

Lame extra fine - particulièrement appropriée pour les zones difficiles d'accès. Lames en acier SK5 - dents trempées par induction.

Sierra japonesa

Hoja extra delgada, especialmente indicada para trabajar en sitios de difícil acceso. Hojas en acero SK5 alta aleación, dientes templados por inducción.



Inkl. 2 Sägeblätter (fein/mittel). Austausch des Sägeblattes durch Knopfdruck. Lieferung in Blisterverpackung. Incl. 2 saw blades (fine/medium). Replacing the blade by pressing a button. Supplied in blister packing.

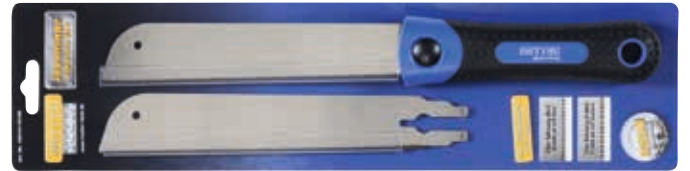

Sauberer, glatter Schnitt durch feine Zahnung
Clean and smooth cut appearance by fine toothting

Schnittbild mit herkömmlicher Säge
Cut appearance of a conventional saw

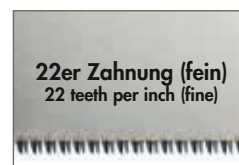

22er Zahnung (fein)
22 teeth per inch (fine)

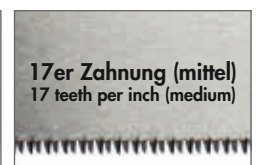

17er Zahnung (mittel)
17 teeth per inch (medium)



5081613

3-tlg./pcs./-dlg./pces./pzs.

Multifunktion Handsäge

Griff in zwei Winkel einstellbar, einfache Handhabung. Hochwertiger 2-K Kunststoffhandgriff. Der Griff nimmt sowohl Säbelsägeblätter mit 1/2" Standardaufnahme als auch 1/4" Standardbits auf, sicherer Halt und einfacher Austausch. Zwei Winkeleinstellung möglich, der Griff rastet automatisch in die Arbeitsposition ein.

Multifunction handsaw

Two angles adjustable, easy handling. High-quality 2-K plastic handle. Handle accepts 1/2" reciprocating saw blades and standard 1/4" hexagon bits, safe hold and easy replacement of the saw blade. Two angle settings, handle automatically locks into position.

Multifuncionele handzaag

Greep in 2 standen verstelbaar, eenvoudig te gebruiken. Hoogwaardige 2-comp. kunststof greep. Greep is geschikt voor 1/2" reciprocagen en 1/4" bits, stevige verandering en eenvoudig verwisselbaar. Twee instelbare hoeken mogelijk, de greep blokkeert automatisch in positie.

Scie à main multifonction

Poignée réglable en deux angles, manipulation facile. Manche en plastique, 2 composants, haute qualité. Utilisable avec les lames de scies sabres standard 1/2" ou comme porte-embouts 1/4". Remplacement rapide des outils. Verrouillage automatique dans la position de travail.

Sierra de mano multifuncional

Mango ajustable en 2 ángulos, manejo sencillo. Mango de plástico 2K de calidad. El mango vale para aceptar hojas de sierra con conexión estándar 1/2", así como de 1/4". Bist. estándar de sujeción segura y fácil cambio. Posibilidad de 2 ángulos, el mango se posiciona automáticamente.



Je ein Sägeblatt für Metall 6"X24T / Holz 6"X10T, Zähne induktiv gehärtet. Besonders geeignet für schwer zugängliche Stellen. Lieferung in Blisterverpackung. One saw blade for metal 6"X24T / one for wood 6"X10T, induction hardened teeth. Best suited for areas difficult to access. Supplied in blister packing.



Bestell.-No./Order-No.	Art. No.	CLD mm	g	
50816130000	5081613	280	250	5

Geeignet für HEYTEC Multifunktion Handsäge
 Suitable for HEYTEC multifunction hand saw
 Geschikt voor HEYTEC multifunctionele handzaag
 Convient pour HEYTEC scie à main multifonction
 Adecuadas para sierra multifunción
 Art. No. 5081613

5081613-10

5-tlg./pcs./-dlg./pces./pzs.

Sägeblätter-Set für Holz

Sägeblatt für Holz 6"X10T.

Set of saw blades for wood
 Saw blade for wood 6"X10T.

Set zaagbladen voor hout
 Zaagblad voor hout 6"X10T.

Jeu de lames de scies à bois
 Lame de scie pour bois 6"X10T.

Juego de hojas de sierra para
 madera

Hoja de sierra para madera 6"X10T.



Bestell-No./Order-No.	Art. No.	CLD mm		
50816131000	5081613-10	150	110	10

5081613-20

5-tlg./pcs./-dlg./pces./pzs.

Sägeblätter-Set für Metall

Sägeblatt für Metall 6"X10T.

Set of saw blades for metal
 Saw blade for metal 6"X10T.

Set zaagbladen voor metall
 Zaagblad voor metall 6"X10T.

Jeu de lames de scie à métaux
 Lame de scie pour métal 6"X10T.

Juego de hojas de sierra para
 metal

Hoja de sierra para metal 6"X10T.

Hochwertige Sägeblätter, Zähne induktiv gehärtet.
 Sicherer Halt und einfacher Austausch des Sägeblattes.



Bestell-No./Order-No.	Art. No.	CLD mm		
50816132000	5081613-20	150	110	10

5081613-30

Handgriff für Multifunktion Handsäge

Griff in zwei Winkel einstellbar, einfache
 Handhabung. Hochwertiger 2-K Kunst-
 stoffhandgriff.

Handle for multifunction
 handsaw

Two angles adjustable, easy handling.
 High-quality 2-K plastic handle.

Greep voor multifunctionele
 handzaag

Greep in 2 standen verstelbaar, eenvou-
 dig te gebruiken. Hoogwaardige 2-comp.
 kunststof greep.

Poignée pour scie à main
 multifonction

Deux angles réglables, manipulation
 facile. Manche en plastique 2-C de haute
 qualité.

Mango para sierra de mano
 multifuncional

Mango ajustable en 2 ángulos, manejo
 sencillo. Mango de plástico 2K de gran
 calidad.



Besonders geeignet für schwer zugängliche Stellen.
 Der Griff nimmt sowohl Säbelsägeblätter mit 1/2"
 Standard-aufnahme als auch 1/4" Standardbits auf.
 Extra thin blade - best suited for areas difficult to access.
 Handle accepts 1/2" reciprocating saw blades and
 standard 1/4" hexagon bits.



Bestell-No./Order-No.	Art. No.	CLD mm		
50816133000	5081613-30	160	200	5

50816152400

Dämmstoffmesser

Spezial-Klinge mit Glattschliff. Zum sauberen Schneiden von Styropor, EVA, Glasfaser, Schaum- und Dämmstoffen,

Knife for insulating material

Special blade with straight edge, for clean cutting of polystyrene, EVA, fiberglass, foam and insulation materials.

Isolatiemes

Speciaal lemmet voor een gladde, zuivere snede bij het snijden van polystyreen, EVA, glasvezel, schuim- en isolatiematerialen.

Couteau d'isolation

Lame spéciale lisse pour une coupe propre et droite dans le polystyrène, EVA, la fibre de verre, les mousses et matériaux d'isolation.

Cuchillo para materiales aislantes

Hoja especial con afilado liso. Para el corte limpio de poliestireno, EVA, fibra de vidrio, espuma y materiales aislantes.

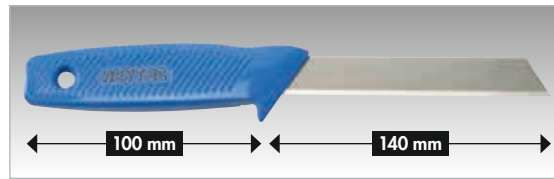

Griff aus kompaktem Zinkdruckguss.
Handle made by compact die cast zinc.

Bestell-No./Order-No.	CLD mm		
50816152400	240	160	1

50816154200

Dämmstoffmesser

Extra starke Klinge, gehärtet und poliert. Klingenspitze geeignet zum Bohren in Dämmstoffen.

Knife for insulating material

Extra thick blade, hardened and polished. Blade tip for drilling in insulated materials.

Isolatiemes

Extra sterk lemmet, gehard en gepolijst. Geslepen punt voor het eenvoudig boren in isolatiematerialen.

Couteau d'isolation

Lame spéciale épaisse, durcie et polie. Pointe pour une entrée facilitée dans les matériaux d'isolation.

Cuchillo para materiales aislantes

Hoja extra fuerte, endurecida y pulida. Punta de la cuchilla adecuada para perforar en materiales aislantes.

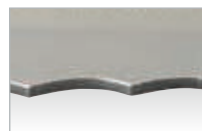

„Wellenschliff“
weite Zahnung für biegsame und weiche Dämmstoffe/Materialien.
‘Wave shaped blade’
wide toothing for flexible and soft insulation materials.

„Sägeschliff“
enge Zahnung für feste und harte Dämmstoffe/Materialien.
‘Saw shaped blade’
narrow toothing for solid and hard insulation materials.

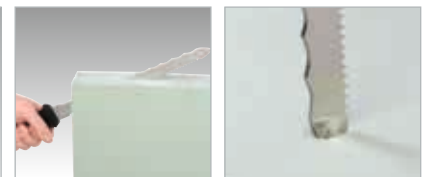
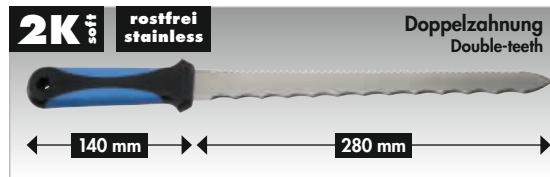

Bestell-No./Order-No.	CLD mm		
50816154200	420	140	1

50816140000

17 Zähne/teeth/tanden/dents/dientes

Bauhandsäge

Für die Bearbeitung/Sägen von Porenbeton- oder Hohlblocksteinen. Hartmetallbestückt, 17 Zähne, Holzgriff, 700 mm Blattlänge.

Construction hand saw

For cutting aerated concrete or hollow blocks. Carbide teeth, 17 teeth, wooden handle, 700 mm blade length.

Gasbetonzaag

Voor het bewerken / zagen gasbeton- of holle blokken. Hardmetalen tanden, 17 tands, houten greep, zaagblad 700 mm.

Scie de chantier

Pour la coupe du ciment et des parpaings. 17 dents carbure, poignée en bois, longueur de lame 700 mm.

Sierra de mano para la construcción

Para el procesamiento/serrado de hormigón celular o bloques huecos. Punta de carburo, 17 dientes, mango de madera, 700 mm de longitud de hoja.



Bestell-No./Order-No.	Art. No.	Maße · Dimensions		
50816140000	5081614	830 x 130 x 25 mm	990	1

5081612

Mini Metallbügelsäge

Mit Schnellspannvorrichtung 150 mm/6" Blattlänge. Profi-Qualität mit ergonomischem 2-K Griff, geprüfte Qualität. Sägeblatt in verschiedene Winkel verstell- und arretierbar.

Mini Hacksaw

With click clamp device 150 mm/6" blade length. Profi-quality with 2-K-handle, ergonomically hand mould, certified quality.

Juniorzaagbeugel

Met snelspanklem, 150 mm/6" zaagblad. Professionele kwaliteit met ergonomische 2 componenten greep, kwaliteit getest. Zaagblad in verschillende hoeken verstell- en draaibaar.

Mini scie à métaux

À serrage rapide, lame de 150 mm/6". Qualité professionnelle avec poignée à 2 composantes, qualité certifiée. Lame réglable et verrouillable dans différents angles.

Mini sierra para metales

Con dispositivo de sujeción rápida de 150 mm/6" de longitud de hoja. Calidad profesional con mango ergonómico 2-K, calidad probada. Hoja de sierra ajustable y bloqueable en diferentes ángulos.

Lieferumfang mit
1 Sägeblatt Metall (24T/1")
1 Sägeblatt Kunststoff/Holz (18T/1")

Included in delivery
1 saw blade for steel (24T/1")
1 saw blade for plastics/wood (18T/1")

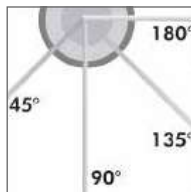

Bestell-No./Order-No.	Art. No.	CLD mm		
50816120000	5081612	150	180	1
50816121000	5081612-1	150 für Stahl (24T/1") *	30	1
50816122000	5081612-2	150 für Kunststoff/Holz (18T/1") *	30	1

* 150 mm for steel
150 mm for plastics/wood

5081610

Metallbügelsäge

Mit Schnellspannvorrichtung 300 mm/12" Blattlänge. Profi-Qualität mit ergonomischem 2-K Griff, geprüfte Qualität. Sägeblatt in verschiedene Winkel verstell- und arretierbar.

Hacksaw

With click clamp device 300 mm/12" blade length. Profi-quality with 2-K-handle, ergonomically hand mould, certified quality.

Metaalzaagbeugel

Met snelspanklem, 300 mm/12" zaagblad. Professionele kwaliteit met ergonomische 2 componenten greep, kwaliteit getest. Zaagblad in verschillende hoeken verstell- en draaibaar.

Scie à métaux

À serrage rapide, lame de 300 mm/12". Qualité professionnelle avec poignée à 2 composantes, qualité certifiée. Lame réglable et verrouillable dans différents angles.

Sierra para metales

Con dispositivo de sujeción rápida de 300 mm/12" de longitud de hoja. Calidad profesional con mango ergonómico 2-K, calidad probada. Hoja de sierra ajustable y bloqueable en diferentes ángulos.

Lieferumfang mit
1 Sägeblatt Metall (24T/1")
1 Sägeblatt Kunststoff/Holz (18T/1")

Included in delivery
1 saw blade for steel (24T/1")
1 saw blade for plastics/wood (18T/1")

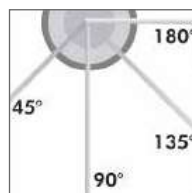

Bestell-No./Order-No.	Art. No.	CLD mm		
50816100000	5081610	300	530	1
50816101000	5081610-1	300 für Stahl (24T/1") *	200	1
50816102000	5081610-2	300 für Kunststoff/Holz (18T/1") *	200	1

* 300 mm for steel
300 mm for plastics/wood
Sägeblätter 10 Stk. im Set · Saw blades 10 pcs. in the set



11 KAPITEL CHAPTER

SANITÄRWERKZEUGE

SANITARY TOOLS

SANITAIRGEREEDSCHAPPEN

OUTILLAGE SANITAIRE

HERRAMIENTAS SANITARIAS

5081054-14

111-tlg./pcs./-dlg./pces./pzs.

**NEU
NEW**

**Sanitär-Werkzeugsatz
in Rucksack**

Hochwertiger Rucksack mit 32 innenliegenden und 4 außenliegenden Einsteckfächern, einem Laptopfach (bis 13,3"), sowie 16 Gummischlaufen für Werkzeuge aller Art. Ausgestattet mit einem umfangreichen Werkzeugsortiment für alle Anlagenmechaniker in der Sanitär-, Heizungs- und Klimatechnik. Neben verschiedenen Steckschlüssel-Einsätzen, Bits, Adaptern, den gängigen Größen an Maulschlüsseln und Knarrenringschlüsseln, sind auch VDE isolierte Werkzeuge für ein sicheres Arbeiten in Hochspannungsbereichen enthalten.

Sanitary tool set in backpack
High-quality backpack with 32 pockets, a laptop compartment (up to 13.3"), 4 external storage compartments and 16 rubber loops for tools of all kinds. Equipped with an extensive range of tools for all plumbing, heating and air conditioning technicians. In addition to various socket spanner inserts, bits, adapters, the standard sizes of open-end spanners and ratchet ring spanners, VDE-insulated tools are included for safe working in high-voltage areas.

**Sanitair gereedschapset
in rugzak**

Hoogwaardige rugzak met 32 inwendige en 4 uitwendige insteekvakken, laptopvak (tot 13,3"), 16 rubberen banden voor allerhande gereedschappen. Voorzien van een omvangrijke gereedschapset voor alle monteurs in de sanitair-, verwarmings- en aircotechniek. Naast verschillende dop sleutels, bits, adapters, de gangbare afmetingen steeksleutels en ringratelsleutels bevat de set ook VDE geïsoleerde gereedschappen voor veilig werken in het hoogspanningsgebied.

**Jeu d'outils de plomberie dans
un sac à dos**

Sac à dos de haute qualité avec 32 poches intérieures et 4 poches extérieures, un compartiment pour ordinateur portable (jusqu'à 13,3"), ainsi que 16 boucles en caoutchouc pour toutes sortes d'outils. Équipé d'un vaste assortiment d'outils pour tous les mécaniciens d'installations dans le domaine de la plomberie, du chauffage et de la climatisation. Outre les différentes douilles, les embouts, les adaptateurs, les tailles courantes de clés plates et de clés à cliquet, il contient également des outils isolés VDE pour travailler en toute sécurité dans les zones à haute tension.

**Juego de herramientas de
fontanería en mochila**

Mochila de alta calidad con 32 bolsillos, un compartimento para portátil (hasta 13,3"), 4 compartimentos de almacenamiento externos y 16 trabillas de goma para herramientas de todo tipo. Equipada con una amplia gama de herramientas para todos los técnicos de fontanería, calefacción y aire acondicionado. Además de varios insertos para llaves de vaso, puntas, adaptadores, los tamaños estándar de llaves fijas y llaves de carraca de anillo, se incluyen herramientas con aislamiento VDE para trabajar con seguridad en zonas de alta tensión.



enthaltend/containing

	180 mm		320 mm
	160 mm		Gr. 18 mm
	200 mm		280 mm
	160 mm		200 mm
	0,4 x 2,5 x 75 mm		150 - 250 V
	0,8 x 4,0 x 100 mm		10 - 32 mm
	1,0 x 5,5 x 125 mm		CL 240 mm
	PH 1 x 100		10/12/17/22 mm
	PH 2 x 100		CL 200 x 200 mm
	8x9 / 10x11 / 12x13 / 14x15 / 16x17 mm		230 mm
	500 g		250 mm
	CE/EN 388-4131 / 9"		MM 1,5/2/2,5/3/4/5/6/8/10
	200 mm		3-32 / CL 135 mm
	3		Ø 42 mm
	7/8/9/10		46-tlg./pcs.
	6/7/8		11-tlg./pcs.
	DIN 3117 160 mm, 6" / 255 mm, 10"		
	10 x 13 x 17 x 19 mm		
	10x13 / 21x23 / 24x27 / 30x32 mm		

Bestell-No./Order-No.	Art. No.	Maße · Dimensions		
50810541400	5081054-14	460 x 360 x 170 mm	12214	1

50848-10
100-tlg./pcs./-dlg./pces./pzs.

NEU
NEW

Sanitär-Werkzeugsatz in Umhängetasche

Hochwertige Aufbewahrungstasche mit Klemmhaltesystem sowie Einsteckfächern für Werkzeuge aller Art. Ausgestattet mit einem umfangreichen Werkzeugsortiment für alle Anlagenmechaniker in der Sanitär-, Heizungs- und Klimatechnik. Neben verschiedenen Steckschlüssel-Einsätzen, Bits, Adaptern, den gängigen Größen an Maulschlüsseln und Knarrenringschlüsseln, sind auch VDE isolierte Werkzeuge für ein sicheres Arbeiten in Hochspannungsbereichen enthalten.

Sanitary tool set in shoulder bag

High-quality storage bag with clamp holding system and compartments for tools of all kinds. Equipped with an extensive range of tools for all plant mechanics in sanitary, heating and air conditioning technology. In addition to various socket spanner inserts, bits, adapters, the usual sizes of open-end spanners and ratchet ring spanners, VDE-insulated tools are included for safe working in high-voltage areas.

Sanitair gereedschapset in tas

Hoogwaardige tas, met klemstelsysteem en insteekvakken voor allerlei gereedschappen. Voorzien van een omvangrijke gereedschapset voor alle monteurs in de sanitair-, verwarmings- en airconditioning. Naast verschillende dopstelsels, bits, adapters, de gangbare afmetingen steeksleutels en ringratelsleutels bevat de set ook VDE geïsoleerde gereedschappen voor veilig werken in het hoogspanningsgebied.

Jeu d'outils sanitaires en sac à bandoulière

Sac de rangement de haute qualité avec système de maintien par serrage ainsi que des compartiments pour toutes sortes d'outils. Équipée d'un vaste assortiment d'outils pour tous les mécaniciens d'installation dans le domaine de la plomberie, du chauffage et de la climatisation. Outre différentes douilles, embouts, adaptateurs, les tailles courantes de clés plates et de clés à cliquet, elle contient également des outils isolés VDE pour travailler en toute sécurité dans les zones à haute tension.

Juego de herramientas fontanería en bandolera

Bolsa de almacenamiento de alta calidad con sistema de sujeción de pinzas y compartimentos para herramientas de todo tipo. Equipado con una amplia gama de herramientas para todos los mecánicos de instalaciones de tecnología sanitaria, calefacción y aire acondicionado. Además de diversos insertos para llaves de vaso, puntas, adaptadores, los tamaños habituales de llaves fijas y llaves de carraca de anillo, se incluyen herramientas con aislamiento VDE para trabajar con seguridad en zonas de alta tensión.



enthaltend/containing

	180 mm		320 mm
	160 mm		500 g
	200 mm		200 mm
	160 mm		150 - 250 V
	0,4 x 2,5 x 75 mm		10 - 32 mm CL ⇌ 240 mm
	0,8 x 4,0 x 100 mm		10/12/17/22 mm CL ⇌ 200 x 200 mm
	1,0 x 5,5 x 125 mm		8x9 / 10x11 / 12x13 / 14x15 / 16x17 mm
	PH 1 x 100		250 mm
	PH 2 x 100		MM 1,5/2/2,5/3/4/ 5/6/8/10
	280 mm		3-32 / CL ⇌ 135 mm
	Gr. 18 mm		Ø 42 mm
	CE/EN 388-4131 / 9''		46-tlg./pcs.
	3 m		290 mm
	3		37 mm
	7/8/9/10		MM 17 x 19
	6/7/8		
	DIN 3117 160 mm, 6'' / 255 mm, 10''		
	10 x 13 x 17 x 19 mm		
	10x13 / 21x23 / 24x27 / 30x32 mm		
	230 mm		
	670 x 340 mm		



50848-1
Umhängetasche
Shoulder bag
Gereedschapstas
Sacoche à outils
Cartera

79

Bestell-No./Order-No.	Art. No.	Maße · Dimensions		
50848010400	50848-01	555 x 410 x 180 mm	12314	1

508077-646

77-tlg./pcs./dlg./pcs./pzs.

Sanitär Werkzeugkasten mit 6 Modulen

Sanitary tool box with 6 modules

Gereedschapskist met 6 modules

Caisse à outils de plombier avec 6 modules

Caja herramientas para fontanería con 6 módulos



enthaltend/containing

Modul 1



Modul 2



Modul 3

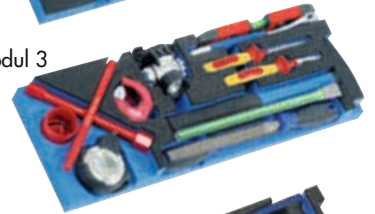

Modul 4



Modul 5



Modul 6

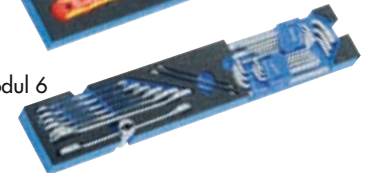

Bestell-No./Order-No.	Art. No.	Maße - Dimensions		
50807764600	508077-646	530 x 200 x 200 mm	16987	1

508077-646

Werkzeugmodul 1

Tool module 1

Gereedschapsmodul 1

Module avec outils 1

Módulo con herramientas 1

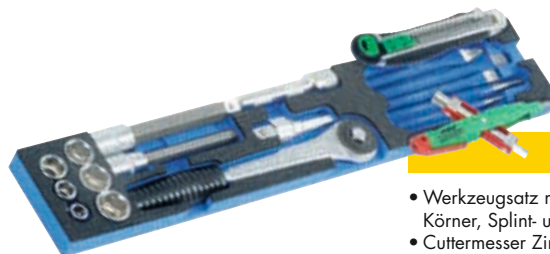

enthaltend/containing

- Werkzeugsatz mit Meißel, Körner, Splint- und Durchtreiber
- Cuttermesser Zinkguss, Klingebreite 18 mm, 5 Klingen
- Universalschlüssel Sanitär/Elektro
- Steckschlüssel Einsätze 6 Kt. 10/13/17/19/21/22 mm
- Stufenschlüssel 3/8", 7/16", 1/2", 5/8" (16mm), 13/16" (21mm)
- Verlängerung 1/2", 125 mm
- Verbindungsvierkant 1/2"
- Durchsteckknarre 1/2"
- Schraubendreher- Einsätze 1/2" 12/17, 138 mm Länge
- Chisel and pin punch set
- Cuttermessers zinc casting, blade range 18 mm, 5 blades
- Control cabinet key electric/sanitary
- Sockets hexagon 10/13/17/19/21/22 mm
- Combination stepped key 3/8", 7/16", 1/2", 5/8" (16mm), 13/16" (21mm)
- Extension bar 1/2", 125 mm
- Square coupler 1/2"
- Ratchet, push through 1/2"
- Screw driver sockets 1/2" 12/17, 138 mm length

508077-646

Werkzeugmodul 2

Tool module 2

Gereedschapsmodul 2

Module avec outils 2

Módulo con herramientas 2



enthaltend/containing

- Greifzange 250 mm
- Eckrohrzange 1.1/2"
- Multigrip plier 250 mm
- Elbow pipe wrench 1.1/2"

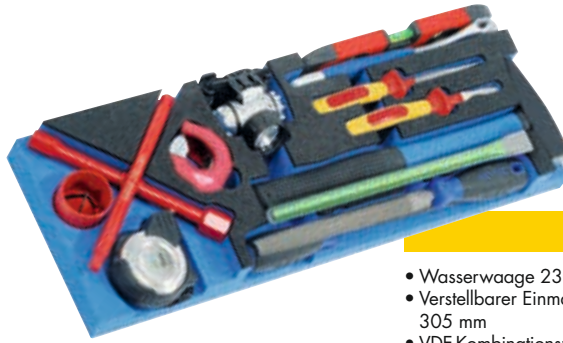

enthaltend/containing

508077-646

Werkzeugmodul 3

Tool module 3

Gereedschapsmodul 3

Module avec outils 3

Módulo con herramientas 3

- Wasserwaage 230 mm
- Verstellbarer Einmaulschlüssel 305 mm
- VDE-Kombinationszange 180 mm
- VDE-Radio- und Telefonzange 200 mm
- Schlosserhammer, Fiberglasstiel, 500 g
- Stirnlampe mit 9 LED's, Gurtband
- Steinmeißel 300 x 24 mm achtkant
- Rohrentgrater innen/aussen Ø 42 mm
- Knarrenrohrabschneider Ø 22 mm
- Halbrundfeile 200 mm
- Rundfeile 200 mm
- Sanitär-Kreuzschlüssel 200x200 mm
- Profi-Bandmaß, Zinkguss, 5 m mit Gürtelclip
- Spirit level 230 mm
- Adjustable wrench 305 mm
- VDE combination plier 180 mm
- VDE radio-/telephone plier, 200 mm
- Engineer's hammer, fibreglass handle, 500 g
- LED headlamp with 9 LED's
- Stone chisel 300 x 24 mm octagonal
- Tube trimming tool inside/outside Ø 42 mm
- Ratchet tube cutter Ø 22 mm
- Engineer files, half-round 200 mm
- Engineer files, round 200 mm
- Sanitary cross wrench 200x200 mm
- Profi measuring tape, zinc, 5 m

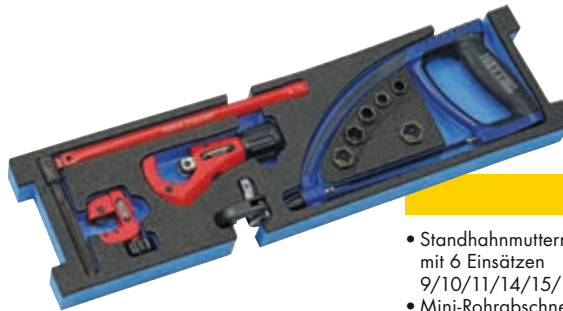

enthaltend/containing

508077-646

Werkzeugmodul 4

Tool module 4

Gereedschapsmodul 4

Module avec outils 4

Módulo con herramientas 4

- Standhahnmutternschlüssel mit 6 Einsätzen 9/10/11/14/15/17 mm
- Mini-Rohrabschneider 3-25 mm
- Teleskop-Rohrabschneider 3-32 mm
- Mini-Metallbügelsäge 150 mm Blattlänge
- Basin wrench with 6 sockets 9/10/11/14/15/17 mm
- Mini tube cutter 3-25 mm
- Telescopic tube cutter 3-32 mm
- Mini hacksaw length of blade 150 mm

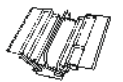
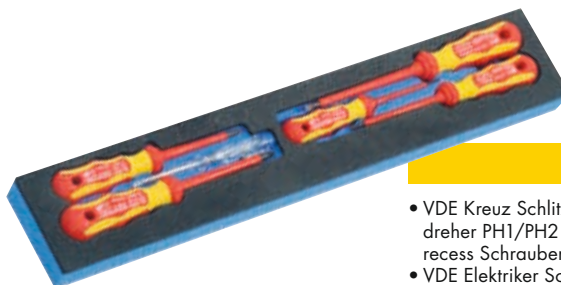

enthaltend/containing

508077-646

Werkzeugmodul 5

Tool module 5

Gereedschapsmodul 5

Module avec outils 5

Módulo con herramientas 5

- VDE Kreuz Schlitzschraubendreher PH1/PH2 für PHILLIPS-recess Schrauben
- VDE Elektriker Schraubendreher für Schlitzschrauben 75x2,5/100x4/125x5,5 mm
- Spannungsprüfer 150-250 V
- VDE cross slot screwdriver PH1/PH2 "PHILLIPS-recess"
- VDE electricians screwdriver for plain slot screws 75x2,5/100x4/125x5,5 mm
- Voltage tester 150-250 V

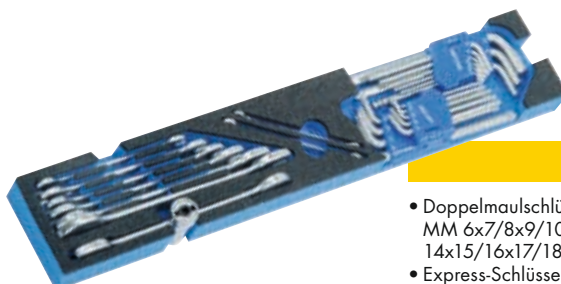

enthaltend/containing

508077-646

Werkzeugmodul 6

Tool module 6

Gereedschapsmodul 6

Module avec outils 6

Módulo con herramientas 6

- Doppelmaulschlüssel MM 6x7/8x9/10x11/12x13/14x15/16x17/18x19/20x22
- Express-Schlüssel MM 17x19
- Kugelkopf-Winkelschraubendreher, 9-tlg. 1,5-10 mm
- TORX-Winkelschraubendreher-satz, 9-tlg. T10-T50
- Double ended open jaw wrench MM 6x7/8x9/10x11/12x13/14x15/16x17/18x19/20x22
- Sanitary wrench MM 17x19
- Set of ball head hexagonal wrenches 9 pcs. 1,5-10 mm
- Set of L-sharpened TORX-wrenches 9 pcs. T10-T50

508200-646

80-tlg./pcs./-dlg./pces./pzs.

Sanitär-Werkzeugsortiment

In 2 L-BOXX®-Koffern:

A: Modul 1+2 mit 36 Werkzeugen

B: Modul 3+4 mit 44 Werkzeugen

Beladungskapazität pro Box bis zu 25 kg.

Transport der Boxen im Verbund bis 40 kg.

Sanitary tool set

In 2 L-BOXX® boxes:

A: Modules 1+2 with 36 tools

B: Modules 3+4 with 44 tools

Loading capacity of up to 25 kg.

Transported in bundles up to 40 kg.

Sanitair gereedschapset

In 2 L-BOXX® kisten:

A: Modules 1+2 met 36 stuks gereedschap

B: Modules 3+4 met 44 stuks gereedschap

Koffer belastbaar tot 25 kg. Bij gekoppelde koffers belastbaar tot 40 kg.

Assortiment d'outils de plombier

En 2 L-BOXX® coffrets:

A: Module 1+2 avec 36 outils

B: Module 3+4 avec 44 outils

Capacité de chargement par boîte

jusqu'à 25 kg. Transport des boîtes en

combinaison jusqu'à 40 kg.

Conjunto de herramientas sanitario

sanitario

En 2 L-BOXX® maletas:

A: Módulos 1+2 con 36 herramientas

B: Módulos 3+4 con 44 herramientas

Capacidad de carga por conjunto hasta

25 kgs. Transporte de las cajas en

conjunto hasta 40 kgs.



508201-762
 Montage-Werkzeugsortiment
 Construction tool set
 Montage gereedschapset
 Assortiment d'outils de mécanicien
 Conjunto de herramientas de montaje



Bestell-No./Order-No.	Art. No.	Maße · Dimensions	Module · Modules	16780	1
50820064600	508200-646	442 x 357 x 151 mm	50807740100 50807740200 50807740300 50807740400		

508200-771

36-tlg./pcs./-dlg./pces./pzs.

Sanitär-Werkzeugsortiment

L-BOXX® Modul 1+2
mit 36 Werkzeugen

Sanitary tool set
L-BOXX® Modules 1+2
with 36 tools

Sanitair gereedschapset
L-BOXX® Modules 1+2
met 36 stuks gereedschap

Assortiment d'outils sanitaire
L-BOXX® Module 1+2 avec 36 outils

Conjunto de herramientas
sanitario

L-BOXX® Módulos 1+2
con 36 herramientas



Beladungskapazität pro Box bis zu 25 kg.
Transport der Boxen im Verbund bis 40 kg.
Loading capacity of up to 25 kg.
Transported in bundles up to 40 kg.

Bestell-No./Order-No.	Art. No.	Maße · Dimensions	Module · Modules		
50820077100	508200-771	442 x 357 x 151 mm	50807740100 50807740200	8030	1

508077-401

26-tlg./pcs./-dlg./pces./pzs.

Sanitär-Werkzeugsortiment für L-BOXX®

Sanitary tool set for L-BOXX®
Sanitair gereedschapset voor L-BOXX®

Assortiment d'outils sanitaire pour L-BOXX®

Conjunto de herramientas sanitario para L-BOXX®



enthaltend/containing	
	260 mm
	MM 17 x 19
	125 mm
	MM 12/17
	MM 10/13/17/19/21/22
	3/8", 7/16", 1/2", 5/8" (16mm), 13/16" (21mm)
	75 mm Ø 42 mm
	Ø 3 - 25 mm
	Ø 3 - 25 mm
	MM 10/12/17/22
	Ø 10 - 32 mm
	1/4"

Bestell-No./Order-No.	Art. No.	Maße · Dimensions		
50807740100	508077-401	405 x 310 x 60 mm	4140	1

5008077-402

10-tlg./pcs./-dlg./pces./pzs.

Sanitär-Werkzeugsortiment für L-BOXX®

Sanitary tool set for L-BOXX®
Sanitair gereedschapset voor L-BOXX®

Assortiment d'outils sanitaire pour L-BOXX®

Conjunto de herramientas sanitario para L-BOXX®



enthaltend/containing	
	180 mm
	200 mm
	PZ 1 / 2
	MM 0,4 x 2,5 x 75 / 0,8 x 4,0 x 100 / 1,0 x 5,5 x 125
	150 - 250 V
	200 mm
	LED

Bestell-No./Order-No.	Art. No.	Maße · Dimensions		
50807740200	5008077-402	405 x 310 x 40 mm	1610	1

508200-772

44-tlg./pcs./-dlg./pces./pzs.

Sanitär-Werkzeugsortiment

L-BOXX® Modul 3+4
mit 44 Werkzeugen

Sanitary tool set
L-BOXX® Modules 3+4
with 44 tools

Sanitair gereedschapset
L-BOXX® Modules 3+4
met 44 stuks gereedschap

Assortiment d'outils sanitaire
L-BOXX® Module 3+4
avec 44 outils

Conjunto de herramientas
sanitario
L-BOXX® Módulos 3+4
con 44 herramientas



Beladungskapazität pro Box bis zu 25 kg.
Transport der Boxen im Verbund bis 40 kg.
Loading capacity of up to 25 kg.
Transported in bundles up to 40 kg.

Bestell-No./Order-No.	Art. No.	Maße · Dimensions	Module · Modules		
50820077200	508200-772	442 x 357 x 151 mm	50807740300 50807740400	8770	1

508077-403

9-tlg./pcs./-dlg./pces./pzs.

Sanitär-Werkzeugsortiment für L-BOXX®

Sanitary tool set for L-BOXX®
Sanitair gereedschapset voor L-BOXX®

Assortiment d'outils sanitaire pour L-BOXX®

Conjunto de herramientas sanitario para L-BOXX®



enthaltend/containing



Bestell-No./Order-No.	Art. No.	Maße · Dimensions		
50807740300	508077-403	405 x 310 x 40 mm	2830	1

508077-404

35-tlg./pcs./-dlg./pces./pzs.

Sanitär-Werkzeugsortiment für L-BOXX®

Sanitary tool set for L-BOXX®
Sanitair gereedschapset voor L-BOXX®

Assortiment d'outils sanitaire pour L-BOXX®

Conjunto de herramientas sanitario para L-BOXX®



enthaltend/containing



Bestell-No./Order-No.	Art. No.	Maße · Dimensions		
50807740400	508077-404	405 x 310 x 55 mm	3320	1

5081791-0

Compact

Profi-Kartuschenpistole

Kompakte Bauform durch innovative innenliegende Betätigungsmechanik. Gleichbleibend kompakte Abmessung, unabhängig vom verbrauchten Inhalt. Mit Verbrauchsanzeige. Nachlaufstop bei Nichtbetätigung.

Profi caulking gun

Compact design through innovative internal actuating mechanism. Consistently compact dimension, regardless of the content consumed. With consumption display. Overrun protection in case of non-operation.

Professioneel kitpistool

Compacte model, dankzij innovatief, inwendig mechanisme. Gelijkblijvende, compacte afmeting, onafhankelijk van het verbruikte materiaal. Met verbruiksindicatie. Met automatische stop.

Pistolet à cartouches professionnel

Design compact avec mécanisme de fonctionnement intérieur innovant. Dimension compacte constante, quelle que soit le matériel consommé. Avec jauge de consommation. Frein spécial en cas de non activité.

Pistola de cartuchos profesional



Diseño compacto gracias su innovadora mecánica de accionamiento. Dimensión uniformemente compacta independientemente del material consumido. Con indicación del consumo. Bloqueo de puesta en marcha involuntaria.



Nur geeignet für leicht pressbare Medien, wie Silikone und Acryle. Nicht geeignet für zähe Medien, wie Kleber! Alternative: Kartuschenpistole Multipower verwenden.

Only suitable for easily compressible media like silicone and acrylic. Unsuitable for viscous media like glue. Alternative: Caulking Gun Multipower.



Bestell-No./Order-No.	Art. No.	Maße · Dimensions		
50817910000	5081791-0	340 x 205 x 65 mm	720	1

5081791-1

Multipower

Profi-Kartuschenpistole

Stabile, aufwendige Konstruktion für extreme Beanspruchung. Betätigung aus hochwertigem Aluminium-Druckguss. Ermüdungsfreies Verarbeiten von sämtlichen Medien durch kraftvolle Hebelübersetzung.

Profi caulking gun

Stable, sophisticated design for heavy duty applications. Actuation mechanism made of high-quality aluminium die-cast. Fatigue-proof processing of any material through powerful leverage.

Professioneel kitpistool

Stabiele, solide constructie voor extreme belastingen. Hefboommechanisme uit hoogwaardig drukkiet aluminium. Moeiteloos verwerken van alle kitsoorten dankzij de sterke overbrenging.



Pistolet à cartouches professionnel

Construction stable pour utilisation dans des conditions extrêmes. Fonctionnement en fonte d'aluminium de haute qualité. Utilisation simple sans effort grâce au levier puissant.

Pistola de cartuchos profesional

Diseño robusto para exigencias extremas. Pousoir en fonte d'aluminium. Procesamiento sin fatiga de toda clase de medios gracias a la transmisión por palanca.



Bestell-No./Order-No.	Art. No.	Maße · Dimensions		
50817910100	5081791-1	360 x 225 x 65 mm	800	1

5081791-2

Multipower Universal

Profi-Kartuschenpistole

- Vollummantelte Kartuschenpistole mit Aluminium Gehäuse aus Strangpressprofil
- Betätigung aus hochwertigem Aluminium-Druckguss
- Universalverarbeitung von Kartuschen und Beuteln
- Stabile, aufwendige Konstruktion für extreme Beanspruchung
- Glasfaserverstärkte Schraubkappen

Profi caulking gun

- Fully coated caulking gun with body made of extruded aluminium
- Actuation mechanism made of high-quality aluminium die-cast
- Universal processing of cartridges and bags
- Stable, sophisticated design for heavy duty applications
- Glassfibre reinforced screw caps

Professioneel kitpistool

- Gesloten kitpistool met hoogwaardige, aluminium behuizing
- Hefboommechanisme uit hoogwaardig drukgiet aluminium
- Voor verwerking van kokers en worsten
- Stabiele, solide constructie voor extreme belastingen

Pistolet pour silicone professionnel

- Pistolet pour silicone entièrement gainé avec boîtier en aluminium profilé extrudé
- Poussoir en fonte d'aluminium de haute qualité
- Utilisation universelle pour cartouche et sachets
- Construction stable pour utilisation dans des conditions extrêmes

Pistola de cartuchos profesional

- Pistola de cartuchos, carcasa de aluminio, perfil extruido
- Accionamiento de fundición inyectada de aluminio de gran calidad
- Procesamiento universal de cartuchos y bolsas
- Diseño robusto para exigencias extremas



310 ml



600 ml

- Für alle gängigen Kartuschen und Beutel mit einem Volumen von 310/600 ml geeignet
- Inklusive zwei Dosierspitzen
- Ermüdungsfreies Verarbeiten von sämtlichen Medien durch kraftvolle Hebelübersetzung
- For all common cartridges and bags with 310/600 ml content
- Including two tube nozzles
- Fatigue-proof processing of any material through powerful leverage



Bestell-No./Order-No.	Art. No.	Maße · Dimensions		
50817910200	5081791-2	360 x 255 x 65 mm	1050	1
50817910300	5081791-3	490 x 255 x 65 mm	1400	1
*50817912200	5081791-22		62	2
**50817912300	5081791-23		300	2

* Dosierspitzenset/Tube nozzles 10-tlg./pcs. für Profi-Kartuschenpistole/for professional caulking gun multipower universal 50817910200/XL: 50817910300
 ** Ersatz Verschlusskappe/Black Cap 2-tlg./pcs. für Profi-Kartuschenpistole/for professional caulking gun multipower universal 50817910200/XL: 50817910300

5081791-90

Fugenabzieher im Set

Zum Abziehen, Glätten und Formen von dauerelastischen Fugenmassen.

Handy screeding pads set

Set of handy screeding pads for skimming, flattening and shaping of permanent elastic joint seals.

Multifunctionele kitlepel

Kitlepel voor het gladstrijken en vormen van elastische kitten.

Set avec 4 palettes à lisser

Pour le retrait, le lissage et le façonnage de joints à élasticité permanente.

Herramienta para retocar juntas, en juego

Juego de herramientas para retocar, alisar y dar forma a juntas de masillas elásticas.

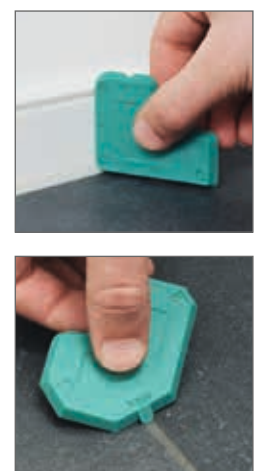
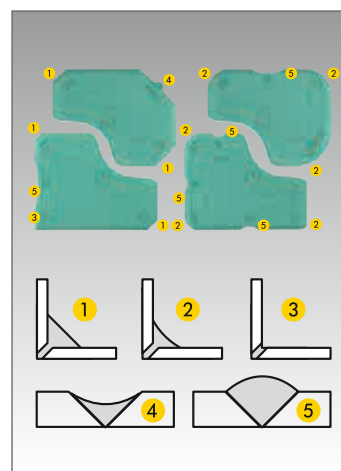

17 verschiedene Möglichkeiten.
17 different alternatives.

Bestell-No./Order-No.	Art. No.	Maße · Dimensions		
50817919000	5081791-90	225 x 160 x 10 mm	88	1

5081791-91

Profi-Kartuschenpistole + Fugenabzieher im Set, 2-tlg.

Betätigung aus hochwertigem Aluminium-Druckguss. Ermüdungsfreies Verarbeiten von sämtlichen Medien durch kraftvolle Hebelübersetzung. Fugenabzieher Set zum Abziehen, Glätten und Formen von dauerelastischen Fugenmassen (17 verschiedene Möglichkeiten).

Profi caulking gun + Handy screeding pads set, 2 pcs.

Actuation mechanism made of high quality aluminium die-cast, Fatigue-proof processing of any material through powerful leverage Handy screeding pads set Set of handy screeding pads for skimming, flattening and shaping of permanent elastic joint seals (17 different alternatives)

Professioneel kitpistool + Multifunctionele kitlepel, 2-dlg.

Bediening van hoogwaardig aluminium gegoten aluminium. Moeiteloze verwerking van alle van alle media dankzij krachtige hefboomoverbrenging. Voegen trekker set voor het strippen, gladmaken en afgieten van blijvend elastische voegkitten (17 verschillende opties).

Pistolet à cartouches professionnel + set avec 4 palettes à lisser, 2 pces.

Actionnement en aluminium coulé de haute qualité moulage sous pression. Traitement sans fatigue des de tous les fluides grâce à un puissant rapport de levier élevé. Set d'extracteurs de joints pour extraire, lisser et former de masses de jointoiment à élasticité permanente (17 différentes possibilités).

Pistola de cartuchos profesional + Herramienta para retocar juntas, en juego, 2 pzs.

Accionamiento de fundición inyectada de aluminio de gran calidad Herramienta para retocar juntas, en juego Juego de herramientas para retocar, alisar y dar forma a juntas de masillas elásticas.

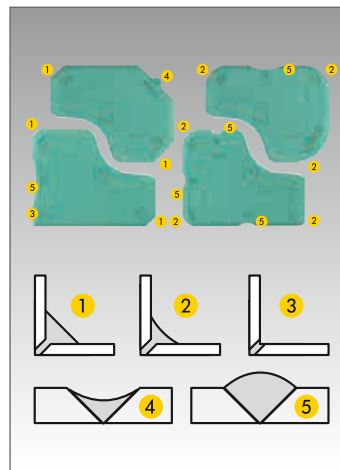

Bestell-No./Order-No.	Art. No.	enthaltend/containing		
50817919100	5081791-91	5081791-1/ 5081791-90	888	1

5081790-1

DIN 1283 Handhebelfettpresse

L = lackiert, Kopf aus Zinkdruckguß, robuster Stahlrohrkörper zur Füllung mit Kartuschen, lose m Fett und durch Füll-geräte.

Profi caulking gun

L = lacquered, head of zinc die-casting, robust steel body for loading with cartridges, bulk grease or by filler pumps.

Schaarvetspuit

L = gelakt, kop uit druk-gietzink, robuuste behuizing voor het vullen met vetpatronen, los vet d.m.v. hand en los vet d.m.v. vulapparaat.

Pompe à graisse à levier

Tête en zinc injecté, corps robuste en tôle à remplir de cartouches de graisse. Idéal pour la lubrification mécanique des outils et machines.

Prensa manual de engrasar

L = lacada. cabezal de fundición inyectada, cuerpo robusto de tubo de acero para carga con cartuchos, grasa a granel mediante aparatos de recarga.



- Ideal zum Schmieren von mechanischen Werkzeugen und Maschinen, universell passend für alle gängigen Schmiernippel
- Ergonomischer Handgriff
- Ideal for lubricating mechanical tools and machines, universally suitable for all standard grease fitting
- Ergonomic handle

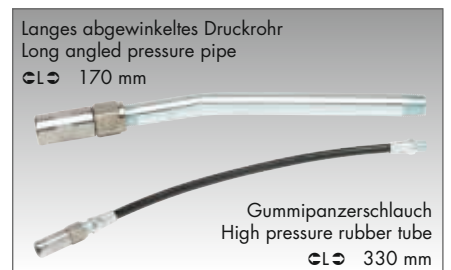

Bestell-No./Order-No.	lose/bulk	Inhalt/capacity ccm Kartuschen/cartridges			
50817900120	500	400	380/690 mm	1100	1

5021450-1 5021450-2

Saugheber

Aus hochwertigem Aludruckguss. Ansaugmechanik und Sicherheitsverriegelung. Ideal zum Transportieren, Ein- und Ausheben von PKW-Glas, Duschwannen, Fensterscheiben, Türen, Blechen, etc.

Vacuum lifting pad

Made of high grade aluminium die cast. Suction mechanism with safety locking, ideal for lifting and transporting sheet metal, plastic sheets, glass panels, installation of windscreens, doors etc.. Movable suction cups particularly suitable for curved windscreens.

Zuigheffer

Uit hoogwaardig spuitgiet aluminium. Anzuigmechanisme en veiligheidsverrendeling. Ideaal voor transporteren, plaatsen en verwijderen van autoruiten, douchewanden, vensterglas, deuren, etc..

Ventouses de portage

En aluminium de haute qualité. Système mécanique d'aspiration et blocage de sécurité idéal pour transporter, monter et démonter des pare-brises, portes, tôles etc..

Ventosas

De aluminio de gran calidad. Mecanismo de vacío y cierre de seguridad, ideal para transportar, montar y desmontar cristales, parabrisas, puertas, chapas etc..

80 kg

5021450-1
2 bewegliche Saugköpfe.
Traglast gesamt: 80 kg.
2 suction cups.
Capacity: 80 kg.



120 kg

5021450-2
3 bewegliche Saugköpfe.
Traglast gesamt: 120 kg.
3 suction cups.
Capacity: 120 kg.



Bestell-No./Order-No.	Art. No.	Maße · Dimensions			
50214500100	5021450-1	225 x 160 x 10 mm	80 kg	2200	1
50214500200	5021450-2	370 x 325 x 90 mm	120 kg	4500	1

5081640-25

Mini-Rohrabschneider

Für enge Arbeitsbereiche, Schneidkapazität von Rohren Ø 3-25 mm, sichere Kraftübertragung durch Doppelführung.

Mini tube cutter

For hard of access workplaces, cutting capacity for tubes from 3 till 25 mm, power transmission secured thanks a double guiding.

Mini pijpsnijder

Voor kleine werkrumtes, snijcapaciteit van buizen Ø 3-25 mm, goede krachtoverbrenging dankzij dubbele geleiding.

Mini coupe-tube

Pour des travaux difficiles d'accès, capacité de coupe de tubes de 3 à 25 mm, transmission de force assurée par un double guidage.

Mini-cortatubos

Para trabajar en sitios limitados, Capacidad de corte para tubos de Ø 3 a 25 mm, Sugura aplicación de fuerza gracias a la guía doble.



Spezielle Bauform mit kleinem Arbeitsradius.
Special construction with a reduced working range.

Bestell-No./Order-No.	Art. No.	Ø mm			
50816402500	5081640-25	80	3-25	160	1
50816430100	5081643-1	Stahl	16	5	1
50816430200	5081643-2	Kupfer	16	5	1

* Ersatz-Schneiderrad · Replacement cuttingwheel
* Stahl/Kupfer · Steel/Copper

5081640-32

Teleskop-Rohrabschneider

Für dünnwandige Rohre Ø 3-32 mm, max. Wanddicke bis 4 mm, sichere Kraftübertragung durch Teleskopführung.

Telescopic tube cutter

For thin wall tubes from 3 till 32 mm, wall thickness till 4 mm, power transmission secured through telescopic guiding.

Telescopische pijpsnijder

Voor dunwandige pijp Ø 3-32 mm, max. wanddikte tot 4 mm, goede krachtoverbrenging door telescoopgeleiding.

Coupe-tube télescopique

Pour tubes à paroi mince, diamètre de 3 à 32 mm, paroi ép. maxi jusqu' à 4 mm, transmission de force assurée par un guidage télescopique.

Cortatubos telescópico

Para tubos de pared delgada de Ø 3 a 32 mm, grosor máximo de pared 4 mm, avance de la cuchilla por sistema telescópico.



Schneiderad aus Spezialstahl für extrem lange Haltbarkeit, leichtes Verstellen des Arbeitsbereiches.

High quality cutting wheel out of special steel for an outer long life, easy and quick fitting to the working areas.

Bestell-No./Order-No.	Art. No.	Ø mm			
50816403200	5081640-32	135	3-32	400	1
50816430100	5081643-1	Stahl	16	5	1
50816430200	5081643-2	Kupfer	16	5	1

* Stahl/Kupfer · Steel/Copper

5081643-15 / 5081643-22

Knarrenrohrabschneider

Ideal für schwer zugängliche Stellen, kein Nachstellen erforderlich, da Eigenklemmung und Selbstnachstellung.

Ratchet tube cutter

Ideal for hard of access workplaces, no adjustment needed, automatic setting up and clamping.

Ratel pijpsnijder

Ideaal voor moeilijk bereikbare plaatsen, geen nastellen nodig, klemt en stelt automatisch bij.

Coupe-tubes à cliquet

Idéal pour les endroits difficiles d'accès, pas de réglage nécessaire.

Cortatubos de carraca

Para trabajar en sitios limitados, no necesita re-ajuste, debido a su acoplamiento y ajuste automáticos.



Schnelles Trennen von Rohren mit wenigen Umdrehungen.

Quick cut of tubes with very few rotations.

Bestell-No./Order-No.	Art. No.	Ø mm			
50816431500	5081643-15	65	15	245	1
50816432200	5081643-22	75	22	276	1
50816430300	5081643-3	Kupfer	16	5	1

* Ersatz-Schneiderad · Replacement cuttingwheel

* Kupfer · Copper

5081640-42

Rohrentgrater

Außen/Innen. Massives Zinkdruckgußwerkzeug, Entgratung von Rohren bis Ø 42 mm, gehärtete Spezialklingen.

Tube trimming tool

Outside/Inside. Die-cast zinc, tube trimming till Ø 42 mm, special hardened sharpener.

Pijpontbramer

Buiten/Binnen. Massief zinksplietgereedschap, ontbramen van pijpen tot Ø 42 mm, geharde speciale messen.

Ebavureur de tubes

Extérieur/Intérieur. Ebavureur de tubes de qualité en zinc moulé sous pression. Ebavurage des tubes jusqu' à 42mm, affûteur spécial trempé.

Rebabadador

Exterior/Interior. Rebabadador de calidad, de fundición inyectada, rebabado de tubos de hasta Ø 42 mm, cuchillas especiales, templadas.



Einfache Handhabung.

Easy handling.

außen, outside, extérieur, exterior innen, inside, intérieur, interior

Bestell-No./Order-No.	Art. No.	Ø		
50816404200	5081640-42	42	245	1

5081646-42

Kunststoff-Rohrabschneider

Zum Schneiden von PVC Kabelkanälen, Plastikrohren, Gummischläuchen, etc. Schneidekapazität bis Ø 42 mm mit Ratschenfunktion. Robuster Aluminiumkörper.

PVC Pipe tube cutter

For effortless cutting of PVC cable channels, plastic pipes, rubber tubes, etc. Cutting capacity till Ø 42 mm with ratchet function. High quality aluminium body.

PVC schaar

Voor het knippen van PVC kabelgoten, kunststof buizen, rubber slangen, etc. Snijscapaciteit tot Ø 42 mm. Met ratel-functie. Robuuste aluminium uitvoering.

Coupe tube PVC

Pour couper les conduites de câbles en PVC et tuyaux en caoutchouc. Capacité de coupe jusqu'à 42mm de diamètre, à cliquet. Corps en aluminium solide.

Cortatubos para tubos de plástico

Para cortar toda clase de tubos de PVC y goma. Capacidad de corte hasta 42 mm Ø con función de carraca. Cuerpo robusto de aluminio.



Bestell-No./Order-No.	Art. No.	CLD mm	Ø	g	pcs.
50816464200	5081646-42	210	42	370	1

5081648

4-tlg./pcs./-dlg./pces./pzs.

Drahtsäge Set

Bestehend aus 2 spiralverzahnten Säge-drähten, sowie 2 Zugringen.

Wire saw set

Consisting of 2 spiral-toothed cutting wires and 2 pull rings.

Draadzaagset

Bestaand uit 2 spiraalvertande zaagdra-den en twee grepen.

Scie fil

Comprenant de 2 fils de coupe en spirale à dents et 2 anneaux de traction.

Juego de sierras de alambre
Compuesto de 2 sierras de alambre con dentado espiral y 2 anillas de tiro.

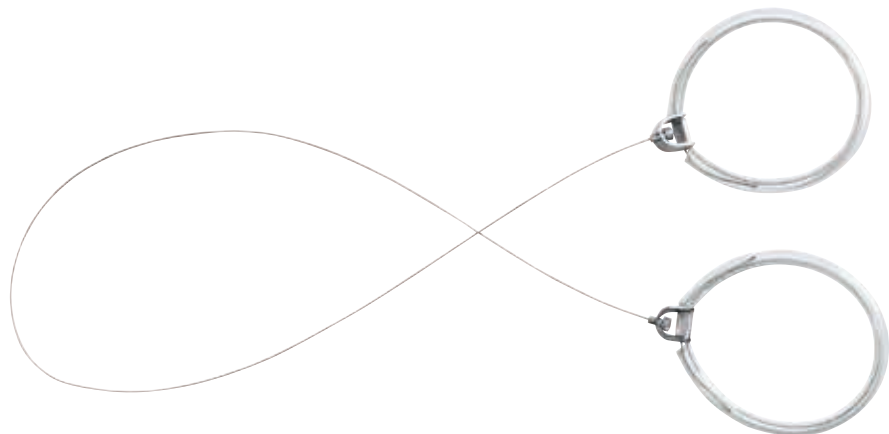

Zum Schneiden von ABS, PVC und CPVC Rohren in Ecken und an schwer zugänglichen Stellen. In Abhängigkeit des zu schneidenden Materials, mehrmaliger Einsatz möglich.

For cutting of ABS, PVC and CPVC tubes in corners and in hard to access workplaces. Depending on the material to be cut repeated use is possible.



Bestell-No./Order-No.	Art. No.	CLD mm	g	pcs.
50816480000	5081648	800	30	1
*50816480200	5081648-2	600	20	1

* Ersatz-Sägedraht, 2-tlg. · Spare cutting wire, 2 pcs.

5081756-1

2 in 1 Kupferrohrbürste

Für Innen- und Außenreinigung von Kupferrohren. Ø 15 mm / Ø 22 mm.

2 in 1 Copper tube pouch

For inner- and outer cleaning of copper tubes. Ø 15 mm / Ø 22 mm.

2 en 1 pijpborstel

Voor in- en uitwendig reinigen van koperen pijp. Ø 15 mm / Ø 22 mm.

Brosse à tube en cuivre 2-en-1

Pour nettoyage intérieur et extérieur des tuyaux en cuivre. Ø 15 mm / Ø 22 mm.

2 en 1 Cepillo para tubos de cobre

Para la limpieza interior y exterior de tubos de cobre. Ø 15 mm / Ø 22 mm.



Bestell-No./Order-No.	Art. No.	CLD mm	Ø	g	
* 50817560100	5081756-1	200	15 / 22 mm	100	1

* Auslauf / Discontinued

50958

Express-Schlüssel

Chrom-Vanadium, verchromt, Montageschlüssel für Express- und Stockschrauben, Mittelstück mit Innengewinde für Stockschrauben M 10.

Sanitary wrench

Chrome-Vanadium, chromium plated, for bathroom fittings attachment (metric screws).

Sanitair sleutel

Chroom-Vanadium, verchromd, montage sleutel voor sanitair schroeven M 10.

Clé sanitaire

Chrome-vanadium, chromé, pour le montage et démontage facile des lavabos. Partie Médiane avec filetage et bille intégrée pour tiges filetées M10.

Llaves para tornillos tipo

Express

Cromo Vanadio, cromadas, llaves para montar tornillos tipo Express y Stock, pieza central con rosa interior para tornillos Stock M 10.



Für Waschtischbefestigungen und Eckventilmontagen.
For bathroom fittings attachment (metric screws).

Bestell-No./Order-No.	Art. No.	MM	CLD mm	g	
50958171980	50958	17 x 19	223	265	5

Chrom-Vanadium, verchromt
 Chrome-Vanadium, chromium plated
 Chrom-Vanadium, verchromd
 Chrome-Vanadium, chromées
 Cromo Vanadio, cromadas

50750-01

DIN 3122 C

2-tlg./pcs./-dlg./pces./pzs.

Durchsteckknarre
 mit Verbindungsvierkant

Ratchet, with square coupler

Doorsteekratel

met verbindingsvierkant

Cliquet avec carré conducteur

Carraca pasante de

acoplamiento cuadrado



Bestell-No./Order-No.	Art. No.		CLD mm		
50750010080	50750-01	1/2"	260	490	5

50750-01-1

DIN 3122 C

Durchsteckknarre

ohne Verbindungsvierkant

Ratchet, without square coupler

Doorsteekratel, zonder

verbindingsvierkant

Cliquet sans carré conducteur

Carraca, sin cuadradillo



Bestell-No./Order-No.	Art. No.	CLD mm		
50750010180	50750-01-1	260	430	5

90050-16

Verbindungsvierkant

für 1/2" Verbindungen.

Square coupler

for 1/2" connections.

Verbindingsvierkant

voor 1/2" hulpstukken.

Carré conducteur

pour connexions 1/2".

Adaptador

para 1/2" conexions.



Bestell-No./Order-No.	Art. No.	CLD mm		
90050160083	90050-16	37	45	10

90050-4

Stufenschlüssel

Für Ein- und Ausbau von Heizkörperventilnippeln, Rücklaufverschraubungen und kurzen Hahnverlängerungen.

Combination stepped key

For pin, hexagon and double hexagon drivers, for installing and removing radiation valves, run-back screws and short tap extensions.

Trapsleutel

Voor in- en uitdraaien van radiatorkop-pelingen, terugslagkleppen, en korte kraanverlengstukken.

Clé étagée

Pour le montage et démontage de vannes de radiateur, clapet anti-retour et rallonges courtes de robinets.

Llaves escalonadas

Llaves combinadas para montar y desmontar valvulas de radiador, racores de retorno y sxtensions de grifo cortos.



3/8",
 7/16",
 1/2",
 5/8" (16mm),
 13/16" (21mm)



Bestell-No./Order-No.	Art. No.	CLD mm		
90050400080	90050-4	90	120	1

Chrom-Vanadium, verchromt
 Chrome-Vanadium, chromium plated
 Chrom-Vanadium, verchromd
 Chrome-Vanadium, chromées
 Cromo Vanadio, cromadas

58103

Stufenschlüssel-Satz

In Kunststoffschraubverpackung.

Stepped wrench
 and ratchet set

In screw cap plastic tube.

Trapsleutelset

In kunststof schroeffoker.

Jeu cliquet et clé étagée

En étui plastique cylindrique.

Conjuntos de llaves

escalonadas con carraca

En tubo de plástico con tapa a rosca.



Bestell-No./Order-No.	Art. No.	Ø mm	g	1
58103000100	58103	290	610	1

98263-06

Spezial-Kardangeln

Beide Antriebsseiten mit Innenvierkant.

Universal joint, special
 With two female squares.

Speciaal cardangewricht

Beide zijden met binnenvierkant 1/2".

Cardan universel spécial

Les deux côtés d'entraînement avec carré intérieur.

Articulación universal especial

Ambos lados con cuadradillo hembra.



Bestell-No./Order-No.	Art. No.	Ø mm	g	1
* 98263060080	98263-06	65	180	1

* Auslauf / Discontinued

50780

11-tlg./pcs./dlg./pcs./pzs.

Sanitär-Garnitur

In Metallkasten.

Sanitary tool set

In metal case.

Sanitair gereedschapset

In metalen kist.

Jeu d'outils «sanitaire»

En coffret métallique.

Conjunto para fontaneros

En casa metálica.



enthaltend/containing

	MM 10/13/17/19/21
	260 mm
	MM 17 x 19
	125 mm
	90 mm
	MM 6
	34 mm



Bestell-No./Order-No.	Art. No.	Maße · Dimensions	g	1
50780809580	50780	320 x 120 x 50 mm	2480	1

508494-016

Ölbrennerschlüssel
 Oil burner key
 Oliebrander sleutel
 Clé mixte à douille pour
 chaudière
 Llave para quemador aceite

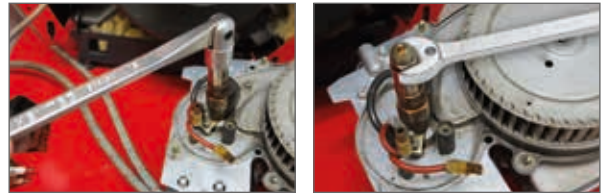

Bestell-No./Order-No.	Art. No.	MM	mm	g	
50849401680	508494-016	16	250	250	1

50889694400

6-tlg./pcs./-dlg./pces./pzs.

Rohrsteckschlüssel-Satz
 verchromt, inklusive Drehstift
 Double ended tubular socket
 wrench set
 chromium plated, with tommy bar
 Pijpsleutelset
 verchromd, met wringstaaf
 Jeu de clés en tube
 chromées, avec tige de serrage
 Juego llave de tubo
 cromado, incluye pasador



Bestell-No./Order-No.	MM	g	
50889694400	8x9 / 10x11 / 12x13 / 14x15 / 16x17 mm	370	1

50896101360 50896111260

Rohrsteckschlüssel
 Lange Ausführung.
 Double ended tubular socket
 wrenches
 Long version.
 Pijpsleutel
 Lange uitvoering.
 Clés en tube
 Version longue.
 Llaves de tubo
 Versión larga.



Besonders geeignet zur Amaturenmontage an bedingt zugänglichen Arbeitsbereichen an Waschbecken, Spülen und Verschraubungen an Gewindestangen.
 Particularly suitable for mounting fittings in difficult to access working areas.

Bestell-No./Order-No.	mm	MM	g	
50896101360	300	10/13	143	1
50896111260	300	11/12	143	1

90950

Standhahnmutternschlüssel

Chrom-Vanadium, lackiert, gesenkschmiedet, sehr robust, schwenkbarer Quergriff, mit schwenkbarer, gefederter Klaue für Rechts- und Linksgang. Für sämtliche Verschraubungen und Standhähne geeignet.

Basin wrench

Chrome-Vanadium, lacquered, with pivoted hook for right-hand or left-hand operations.

Kraanmoersleutel

Chroom-Vanadium, gelakt, met zwekbare greep voor links- en rechtshandig gebruik.

Clé à lavabo

Chrome vanadium, laquée, avec manche et mâchoire articulée pour un maniement aisé. Fonctionnement droite/gauche.

Llaves para tuerca de lavabo

Cromo Vanadio, barnizado, forjadas, muy robustas, manivela articulada, con garra articulada y con muelle, para montar y desmontar.



Bestell-No./Order-No.	Art. No.	mm	∅	AF	CL∅ mm	g	Stk
90950103220	90950	10 - 32		3/8" - 1.1/4"	240	520	2

90955

Sanitärkreuzschlüssel

Lackiert, Spezialschlüssel für die Sanitärtechnik, zum Ein- und Ausbau von Hahnverlängerungen, Heizkörperventile, sowie Rücklaufverschraubungen 3/8" / 1/2" / 3/4" / 1" und Express Schrauben M 8 / M 10 / M 12.

Sanitary cross wrench

Lacquered, special wrench for sanitary installation, for valve extensions, for short tap extensions, installation and removal of heating valves and tank connectors 3/8" / 1/2" / 3/4" / 1". Boits: M 8 / M 10 / M 12.

Sanitair kruissleutel

Gelakt, speciale sleutel voor de installatietechniek, voor in- en uitdraaien van kraanverengstukken 3/8" / 1/2" / 3/4" / 1" en montagesbouten M 8 / M 10 / M 12.

Clé sanitaire en croix

Laqué, pour le montage et le démontage: de robinets 3/8" / 1/2" / 3/4" / 1", de vis d'arrêt de fixation de lavabo M 8 / M 10 / M 12.

Llaves en cruz para fontanero

Barnizado, llaves especiales para fontanería, pintadas en epoxi, para montar y desmontar extensiones de grifos 3/8" / 1/2" / 3/4" / 1", para tornillos tipo Express M 8 / M 10 / M 12.



Bestell-No./Order-No.	Art. No.	MM	CL∅ mm	g	Stk
90955020020	90955	10 / 12 / 17 / 22	200 x 200	520	5

50895632036
50895635036

NEU
NEW

Schraublocher

- Chrom-Molybdän-Stahl
- zum Lochschneiden in Aluminium, Stahlblech, Edelstahl etc.
- für Wasserhahn-Anschlüsse, Kabeldurchführungen, Armaturen bei Edelstahl-Spülen, etc.
- geeignet für Aluminium-, Stahl-, Edelstahlbleche, etc.
- Festgelegtes Lochzentrum mit 10 mm Metall-Bohrer vorbohren

Screw Hole Punch

- Chrome-Molybdenum-Steel
- for drilling in aluminium, steel plate, stainless steel etc.
- for tap water connectors, cable entry, tap water connectors, fittings in stainless steel sinks, etc.
- suitable for aluminium, steel, stainless steel sheets, etc.
- Pre-drill the specified hole centre with a 10 mm metal drill bit.

Kraangatpons

- Chrom Molybdeen staal.
- voor gaten snijden in aluminium, staalplaat, rvc, etc.
- voor kraanaansluitingen, kabeldoorvoeren, toebehoren
- voor rvs-spoelen, etc.
- geschikt voor aluminium, staalplaat, rvc, etc.
- gemarkeerd hart van het gat met 10 mm spiraalboor voorboren.

Perforateur

- acier au chrome-molybdène
- pour la découpe de trous dans l'aluminium, la tôle d'acier, l'acier inoxydable, etc.
- pour les raccords de robinets, les passages de câbles, la robinetterie des éviers en inox, etc.
- convient pour les tôles d'aluminium, d'acier, d'inox, etc.
- Pré-percer le centre du trou fixé avec un foret à métaux de 10 mm

Perforadora

- Cromo-molibdeno-acero
- para taladrar en aluminio, chapa de acero, acero inoxidable, etc.
- para conectores de agua corriente, entrada de cables, conectores de agua corriente, accesorios en fregaderos de acero inoxidable, etc.
- adecuado para chapas de aluminio, acero, acero inoxidable, etc.
- Pretaladre el centro del agujero especificado con una broca metálica de 10 mm.



- Gewindeschraube von der später sichtbaren Seite durch das Loch führen und den Schraublocher auf die Gewindeschraube schrauben. Mit 17 mm Maul- oder Ringschlüssel die Gewindeschraube langsam nach rechts drehen bis das Blech durchgebohrt ist.
- Insert the threaded screw through the hole from the side that will be visible later and screw the drill onto the threaded screw. Using a 17 mm open-end or ring spanner, slowly turn the threaded screw to the right until the sheet metal is drilled through.
- Schroefdraad vanuit de later zichtbare zijde door het gat steken en de pons op de schroefdraad schroeven. Met een 17 mm steek- of ringsleutel de schroefdraad langzaam naar rechts draaien tot het staal doorboort is.
- Introduzca el tornillo roscado a través del orificio por el lado que quedará visible posteriormente y enrosque la broca en el tornillo roscado. Con una llave fija o de estrella de 17 mm, gire lentamente el tornillo roscado hacia la derecha hasta perforar la chapa.
- Faire passer la vis filetée par le trou du côté qui est à l'extérieur et visser le perforateur sur la vis filetée. Avec une clé plate ou une clé polygonale de 17 mm, tourner lentement la vis filetée vers la droite jusqu'à ce que la tôle soit percée.



Bestell-No./Order-No.	Ø mm	mm	g	
50895632036	32	17	270	1
50895635036	35	17	320	1



12 KAPITEL CHAPTER

ELEKTRIKER-WERKZEUGE

ELECTRICIAN TOOLS

ELEKTRICIENS-GEREEDSCHAPPEN

OUTILS D'ÉLECTRICIEN

HERRAMIENTAS PARA ELECTRICISTAS

5081054-26

IEC 60900
DIN 7437 / DIN 7438 PZ
26-tlg./pcs./-dlg./pcs./pz.

NEU
NEW



Elektriker Rucksack mit VDE-Werkzeugsortiment

Hochwertiger Rucksack mit 32 innenliegenden und 4 außenliegenden Einsteckfächern, einem Laptopfach (bis 13,3"), sowie 16 Gummischlaufen für Werkzeuge aller Art.

Electrician's backpack with VDE tool assortment

High-quality backpack with 32 pockets, a laptop compartment (up to 13.3"), 4 external storage compartments and 16 rubber loops for tools of all kinds.

Elektriciensrugzak met VDE gereedschapset

Hoogwaardige rugzak met 32 inwendige en 4 uitwendige insteekvakken, laptopvak (tot 13,3"), 16 rubberen banden voor allerhande gereedschappen.

Sac à dos d'électricien avec assortiment d'outils VDE

Mochila de alta calidad con 32 bolsillos, un compartimento para portátil (hasta 13,3"), 4 compartimentos de almacenamiento externos y 16 trabillas de goma para herramientas de todo tipo.

Mochila de electricista con juego de herramientas VDE

Mochila de alta calidad con bolsillo interior separado para herramientas de todo tipo.



enthaltend/containing/composition/contenido

180 mm	200 mm
160 mm	205 mm
200 mm	MM 8/9/10/11/ 13/14/17/19
160 mm	230 mm
200 mm	MM 4,0 x 100 / 5,5 x 125 / 2,5 x 75
150 - 250 V	PZ 1 / 2
115 - 195 mm	300 g
	24 x 250 mm



Bestell-No./Order-No.	Art. No.	Maße · Dimensions		
50810542600	5081054-26	460 x 360 x 170 mm	6000	1

508676-26
 IEC 60900
 DIN 7437 / DIN 7438 PZ
 26-tlg./pcs./-dlg./pcs./pzs.



Elektriker Koffer mit VDE-Werkzeugen

- Hochwertiger ABS-Schalenkoffer aus schlagfestem ABS-Material.
- Stoßschutz aus Gummi
- Hochwertiges Sicherheitsschloß mit Schlüssel und/oder Code abschließbar
- Stabiler und gehärteter Aluminiumrahmen
- Ergonomischer Tragegriff
- Stabiler Deckelhalter
- Dokumentenfach im Deckel
- Trennelemente im Boden
- Ein Panel abnehmbar

Toolcase for electrician with vde tools

- High-quality ABS shell case made of impact-resistant ABS material.
- Rubber impact protection
- High-quality safety lock lockable with key and/or code
- Sturdy and hardened aluminium frame
- Ergonomic carrying handle
- Stable lid holder
- Document compartment in lid
- Dividers in the base
- One panel removable

Elektricienskoffer met VDE gereedschappen

- Hoogwaardige ABS koffer uit slagvast ABS
- Met rubberen stootbescherming.
- Hoogwaardig veiligheidsslot met sleutel of code afsluitbaar
- Robuust en gehard aluminium frame
- Ergonomische greep
- Robuust dekselscharnier
- Documentenvak in deksel
- Verdeellijsten in de bodem
- Eén paneel uitneembaar

Coffret d'électricien avec outils VDE

- Mallette à coque ABS de haute qualité, résistant aux chocs.
- Protection en caoutchouc contre les chocs
- Serrure de sécurité de haute qualité verrouillable par clé et/ou code
- Cadre en aluminium stable et durci
- Poignée de transport ergonomique
- Support de couvercle stable
- Compartiment pour documents dans le couvercle
- Éléments de séparation dans le fond
- Un panneau amovible

Maletín de electricista con herramientas VDE

- Carcasa de ABS de alta calidad fabricada con material ABS resistente a los impactos.
- Protección de goma contra impactos
- Cerradura de seguridad de alta calidad bloqueable con llave y/o código
- Armazón de aluminio robusto y endurecido
- Asa de transporte ergonómica
- Soporte estable en la tapa
- Compartimento para documentos en la tapa
- Separadores en la base
- Un panel extraíble



enthaltend/containing

	200 mm		180 mm
	205 mm		160 mm
	MM 8/9/10/11/13/14/17/19		200 mm
	230 mm		160 mm
	MM 4,0 x 100 / 5,5 x 125 / 2,5 x 75		200 mm
	PZ 1 / 2		150 - 250 V
	300 g		115 - 195 mm
	24 x 250 mm		110 mm

Bestell-No./Order-No.	Art. No.	Maße · Dimensions		
50867626000	508676-26	470 x 370 x 200mm	8300	1

50848-26
IEC 60900
DIN 7437 / DIN 7438 PZ
26-tlg./pcs./-dlg./pces./pzs.



Elektrikertasche mit VDE-Werkzeugsortiment

Electricians bag with VDE tool set

VDE Elektriçiens-gereedschap-set in tas

Sacoche à outils d'électricien, équipée VDE

Bolsa de electricistas con conjunto de herramientas



enthaltend/containing	
	180 mm
	160 mm
	200 mm
	160 mm
	200 mm
	150 - 250 V
	115 - 195 mm
	110 mm
	200 mm
	205 mm
	MM 8/9/10/11/13/14/17/19
	230 mm
	MM 4,0 x 100 / 5,5 x 125 / 2,5 x 75
	PZ 1 / 2
	300 g
	24 x 250 mm

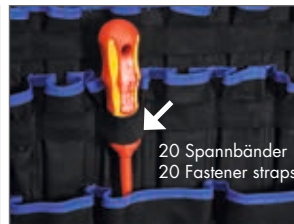

Bestell-No./Order-No.	Art. No.	Maße · Dimensions		
50848002600	50848-26	555 x 410 x 180 mm	6105	1

50848-27
IEC 60900
DIN 7437 / DIN 7438 PZ
28-tlg./pcs./-dlg./pces./pzs.

Elektrikertasche mit VDE-Werkzeugsortiment

Electricians bag with VDE tool set

VDE Elektriçiens-gereedschap-set in tas

Sacoche à outils d'électricien, équipée VDE

Bolsa de electricistas con conjunto de herramientas



enthaltend/containing wie/as 50848002600, jedoch/but	
	12 - 690 V
	12 - 1000 V

Bestell-No./Order-No.	Art. No.	Maße · Dimensions		
50848002700	50848-27	555 x 410 x 180 mm	6380	1

50846-33

IEC 60900:2004
270 1000V11
18-tlg./pcs./-dlg./pces./pzs.



VDE-Elektrikersatz

In Rolltasche mit Gürtelschlaufe.

VDE Electricians-set

In wallet with belt loop.

VDE Elektriciēns-set

In roltas met riemlus.

Outils pour électricien VDE

En trousse avec coulant pour ceinture.

Set eléctrico VDE

En bolsa enrollable con riñonera.



enthaltend/containing

MM 0,4 x 2,5 x 100
 MM 0,6 x 3,5 x 100
 MM 0,8 x 4,0 x 100
 MM 1,0 x 5,5 x 100

TX 10 x 100
 TX 15 x 100
 TX 20 x 100

PZ 1 x 100
 PZ 2 x 100

PH 1 x 100
 PH 2 x 100

150 - 250 V

5 mm / 7 - 8 mm

9 mm

3 - 5 mm

115 mm



Bestell-No./Order-No.	Art. No.	Maße · Dimensions		
50846000033	50846-33	220 x 130 x 70 mm	575	1

50847-33

IEC 60900:2004
270 1000V11
8-tlg./pcs./-dlg./pces./pzs.



VDE-Elektrikersatz

In Rolltasche mit Gürtelschlaufe.

VDE Electricians-set

In wallet with belt loop.

VDE Elektriciēns-set

In roltas met riemlus.

Outils pour électricien VDE

En trousse avec coulant pour ceinture.

Set eléctrico VDE

En bolsa enrollable con riñonera.



enthaltend/containing

MM 0,4 x 2,5 x 100
 MM 0,6 x 3,5 x 100
 MM 0,8 x 4,0 x 100
 MM 1,0 x 5,5 x 100

PH 1 x 100
 PH 2 x 100

115 mm



Bestell-No./Order-No.	Art. No.	Maße · Dimensions		
50847000033	50847-33	220 x 100 x 50 mm	350	1

50849-14
IEC 60900
DIN 7437 / DIN 7438 PZ
13-tlg./pcs./dlg./pces./pzs.



VDE-Elektrikersatz
In Gürteltasche.

VDE Electricians-set
In belt pouch.

VDE Elektriciēns-set
In rīemtas.

Outils pour électricien VDE
En porte-outils de ceinture.

Set eléctrico VDE
En cinturón porta-herramientas.



enthaltend/containing



180 mm



160 mm



200 mm



200 mm



115 - 195 mm



195 - 570 mm



12 - 690 V



150 - 250 V

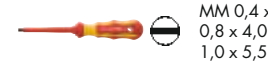

MM 0,4 x 2,5 x 75/
0,8 x 4,0 x 100/
1,0 x 5,5 x 125



PZ 1 / 2

Bestell-No./Order-No.	Art. No.	Maße - Dimensions		
50849001400	50849-14	380 x 300 x 100 mm	2225	1

Modul ***
M 50829-18
IEC 60900
DIN 7437 / DIN 7438 PZ
12-tlg./pcs./dlg./pces./pzs.



VDE-Werkzeugsortiment*
In 2-K Schaumstoffeinlage.

VDE Tool set*
With 2 components foam insert.

VDE Gereedschapset*
In 2 componenten schuiminleg.

Sélection d'outillage VDE*
En plateau mousse bicolore.

Conjunto de herramientas VDE*
Con material de espuma 2 componentes alta gama.

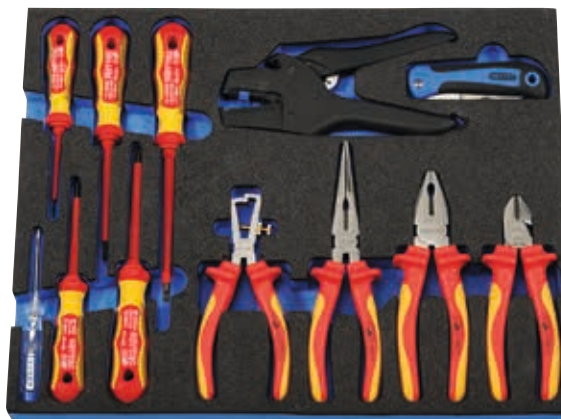

enthaltend/containing



180 mm



160 mm



200 mm



160 mm



200 mm



115 - 195 mm



195 - 570 mm

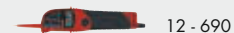

12 - 690 V



150 - 250 V

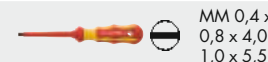

MM 0,4 x 2,5 x 75/
0,8 x 4,0 x 100/
1,0 x 5,5 x 125



PZ 1 / 2

Bestell-No./Order-No.	Art. No.	Maße - Dimensions		
50829001800	M 50829-18	435 x 340 x 35 mm	2910	1

* Passend für HEYTEC-Werkstattwagen 5081129 · For HEYTEC workshop trolley 5081129

- Griffe mit 2-K Isoliergriffen
- Kopf geschliffen und lackiert
- Schneide für mittelharten Draht
- 2K insulated handle
- head ground and lacquered
- cutting edges for middlehard wire

- 2 componenten isolatiegreep
- kop gepolijst en gelakt
- grepen knipt middelharde draad
- Poignées gainées et isolées bimatières
- chromées et laquées branches
- pour fil de dureté moyenne
- mangos con fundas aislantes 2K
- cabeza amolada y barnizada
- cortante para alambre semi-duro



5081200

IEC 900/DIN EN 60900
DIN ISO 5746

VDE Kombinationszange
VDE Combination plier
VDE Combinatietang
VDE Pince universelle
VDE Alicata universal



Bestell-No./Order-No.	Art. No.	Ø mm	g	1
50812001888	5081200-VDE	180	260	1

5081208

IEC 900/DIN EN 60900
DIN ISO 5745

VDE Flachrundzange, gerade
VDE Snipe nose plier, straight
VDE Telefoontang, recht
VDE Pince à becs
demi-ronds, droits
VDE Alicata de radio, recto

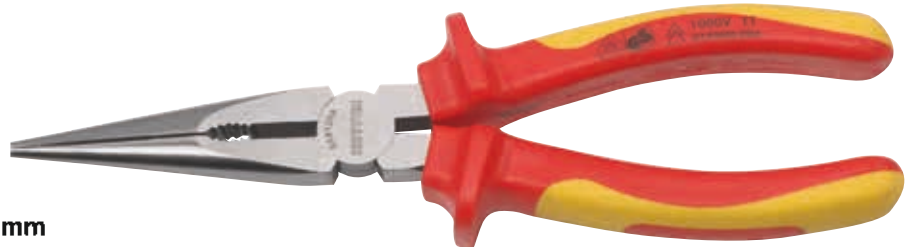

Bestell-No./Order-No.	Art. No.	Ø mm	g	1
50812082088	5081208-VDE	200	185	1

5081209

IEC 900/DIN EN 60900
DIN ISO 5745

VDE Flachrundzange,
45° abgewinkelt
VDE Snipe nose plier,
45° angle
VDE Telefoontang,
45° gebogen
VDE Pince à becs demi-ronds,
coudés à 45°
VDE Alicata de radio,
curvo a 45°



Bestell-No./Order-No.	Art. No.	Ø mm	g	1
50812092088	5081209-VDE	200	185	1

- Griffe mit 2-K Isoliergriffen
- Kopf geschliffen und lackiert
- 2K insulated handle
- head ground and lacquered
- 2 componenten isolatiegreep
- kop gepolijst en gelakt
- Poignées gainées et isolées bimatière
- Tête chromée et laquée
- mangos con fundas aislantes 2K
- cabeza amolada y barnizada



5081212

IEC 900/DIN EN 60900
DIN ISO 5749

VDE Kraftseitenschneider

Spezialstahl, Schneide für harten Draht (Piano Draht).

VDE Diagonal cutting nipper

Special steel, cutting edges for piano wire.

VDE Kracht zijsnijtang

Speciaalstaal, knipt harde draad (piano draad).

Pince coupante VDE

Acier spécial, pour fil dur (corde à piano).

VDE Alicata cortalambre

Acero especial, cortante para alambre cuerda de piano.



2,0



Bestell-No./Order-No.	Art. No.	CLD mm		
50812121888	5081212-VDE	180	255	1

5081213

IEC 900/DIN EN 60900
DIN ISO 5749

VDE Seitenschneider, schwedische Form

Schneide für mittelharten Draht.

VDE Diagonal cutting nipper, swedish pattern

Cutting edges for middlehard wire.

VDE Zijsnijtang, zweeds model

Knipt middelharde draad.

Pince coupante VDE, modèle suédois

Pour fil de dureté moyenne.

VDE Alicata cortalambre, modelo sueco

Cortante para alambre semi-duro.



2,0



Bestell-No./Order-No.	Art. No.	CLD mm		
50812131688	5081213-VDE	160	220	1

5081220

IEC 900/DIN EN 60900

VDE Abisolierzange

Mit Stellschraube und Öffnungsfeder.

VDE Wire stripping pliers

With adjusting screw and spring.

VDE Kabelstriptang

Met stelschroef en veer.

Pince à dénuder VDE

Avec vis de réglage de butée et ressort d'ouverture.

VDE Alicates pelacables

Con tornillo de ajuste y muelle de operatura.



Bestell-No./Order-No.	Art. No.	CLD mm		
50812201688	5081220-VDE	160	203	1

- 2K-VDE-Schraubendreher, ergonomischer Softgriff
- With ergonomic 2 components soft grip plastic handle
- 2 componenten VDE schroevendraaier, ergonomische soft grip
- Tournevis VDE à poignée 2 composants
- Destornillador VDE según mango ergonómico de dos componentes

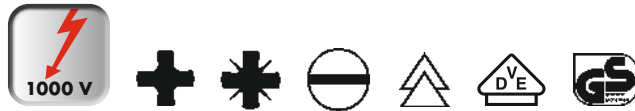

5084511 - 5084536

IEC 60900 : 2004
VDE 006282 Teil/part 201
DIN 7437/DIN 7438 PZ

VDE Schraubendreher

Klingen aus Chrom-Vanadium-Stahl, gehärtet, geschwärzt und mit umspritzter Klingenisolierung.

VDE-Screwdriver

Blades from chrome vanadium steel, hardened, with black tip, insulation of blade and handle injection moulded as one unit.

VDE Schroevendraaier

Klingen uit chroom-vanadiumstaal, gehard, gezwart en met omspoten klingisolatie.

Tournevis VDE

Lame en chrome-vanadium durci, bruni. lame gainée, isolée.

Destornilladores VDE

Varilla de acero al cromo vanadio, templada, pavonada y con aislamiento inyectado.

Bestell-No./Order-No.	Art. No.	+	*	—	g	g
50845110133	5084511 VDE	PH 1			90	10
50845110233	5084511 VDE	PH 2			92	10
50845110333	5084511 VDE	PH 3			94	10
50845120133	5084512 VDE		PZ 1		60	10
50845120233	5084512 VDE		PZ 2		90	10
50845120333	5084512 VDE		PZ 3		92	10
50845367533	5084536 VDE			0,4 x 2,5 x 75 mm	54	10
50845361033	5084536 VDE			0,8 x 4,0 x 100 mm	80	10
50845361233	5084536 VDE			1,0 x 5,5 x 125 mm	82	5

5084550 - VDE

IEC 60900 : 2004
VDE 006282 Teil/part 201
DIN 7437/DIN 7438 PZ
6-tlg./pcs./-dlg./pces./pzs.



VDE Schraubendreher-Satz

VDE-Screwdriver set

VDE Schroevendraaier-set

Tournevis VDE

Destornilladores VDE

Bestell-No./Order-No.	Art. No.	—	*	g	g
50845500033	5084550 VDE		PZ 1 PZ 2	490	1
		0,5 x 2,5 x 75 mm			
		0,8 x 4,0 x 100 mm			
		1,0 x 5,5 x 125 mm			
		Spannungsprüfer/Voltage tester			
		0,75 x 3,0 x 60 mm			

5081424

150 - 250 Volt

Spannungsprüfer, vollisoliert

Vernickelte Klinge, transparenter Griff.

Voltage tester, fully insulated
Blade nickel plated, transparent handle.

Spanningzoeker,

volledig geïsoleerd
Vernikkelde kling, transparante greep.

Détecteur de tension,

isolation totale
Poignée transparente nickelée.

Buscapolos, aislamiento integro

Varilla niquelada, mango transparente.



Bestell-No./Order-No.	Art. No.	—	g	g
50814240050	5081424	0,75 x 3,0 x 60 mm	20	10

50849-9

IEC 60900

9-tlg./pcs./-dlg./pces./pzs.

VDE-Werkzeugsatz

Mit hochwertiger Schaumstoffeinlage in hochwertigem Kunststoffkoffer.

VDE Tool set

With foam insert in high grade plastic case.

VDE Gereedschapset

Met schuiminleg in hoogwaardige kunststof koffer.

Sélection d'outillage VDE

Avec intérieur mousse en coffret plastique.

Conjunto de herramientas VDE

Con material de espuma alta gama en caja de plástico.

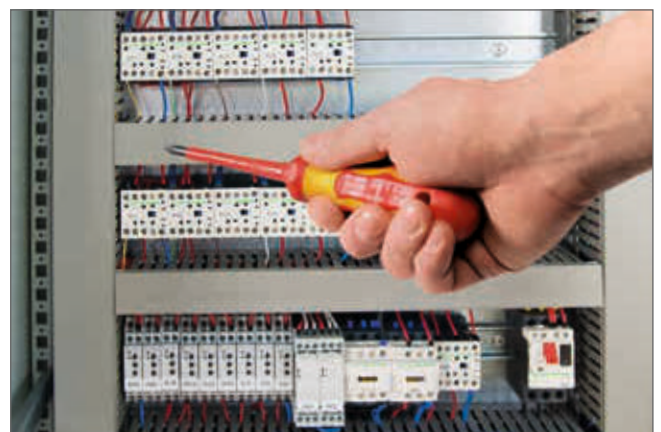

enthaltend/containing	
160 mm	150 - 250 V
200 mm	MM 0,4 x 2,5 x 100 / 0,8 x 4,0 x 100 / 1 x 5,5 x 100
160 mm	PH 1 x 100 / 2 x 100

Bestell-No./Order-No.	Art. No.	Maße · Dimensions		
50849000900	50849-9	340 x 275 x 83 mm	1550	1

5081426

12 - 690 Volt

Spannungsprüfer

LEDs für europäische Spannungsanzeige, L/R LEDs für Phasenrotationstest, Strom-LED, Polaritäts-anzeige-LEDs für Spannung, LCD Display, Durchgangsprüfung, Hochspannungsanzeige. Inklusive Batterien.

Voltage tester

LED's for European voltage indication, L/R LEDs for phase rotation test, Current-LED, polarity indication-LEDs for voltage, LCD Display, Continuity Test, High Voltage Indication. Including batteries.

Spanningtester

LED's voor Europese spanningsaanduiding, L/R LED's voor fase rotatietest, stroom LED, polariteitsaanduiding - LED's voor spanning, LCD display, doorgangstest, hoogspanningsaanduiding. Incl. batterijen.

Détecteur de tension

LED'S pour l'affichage de tension européenne, L/R pour test de rotation de phase, Power LED, affichage de polarité, LED de puissance, écran LCD, Continuité, Indicateur de haute tension. Piles incluses.

Buscapolos

LEDs para indicador de tensión europeo, LED D/I para test de rotación de fase, Luz de LED, LED de indicador de polaridad para tensión, pantalla de LCD, test de continuidad, indicador de alta tensión. Se incluyen baterías.



GS: CAT III 690 V
ETL: CAT IV 600 V



Zweipolig, mit LED-Licht
Bipolar, with LED light

Geprüft nach IEC 61010-1, Schutzart IP 64, automatische Abschaltung.
Complying with IEC 61010-1, protection type IP 64.

12/24/50/120/230/400/690 V



20,65	Art. No.	Volt - Volt		
50814260000	5081426	12 - 690	275	1

5081428

12 - 1000 Volt

Berührungsloser Spannungstester

Kompaktes 2-K Kunststoffgehäuse, mit optischem und zusätzlich akustischem Signal, Einstellrad für Ein- und Ausschalten sowie zur stufenlosen Anpassung an die zu prüfende Spannung und den örtlichen Gegebenheiten.

Contactless voltage tester

Compact 2-k plastic housing, with optical and acoustical signal, with thumb wheel for switching on and off and for continuous adaption to the test voltage and local conditions.

Contactloze spanningsmeter

Compact 2-K kunststof behuizing, met optisch en akoestisch signaal, duimwiel voor in- en uitschakelen en voor traploze aanpassing aan de te meten spanning en plaatselijke condities.

Testeur de tension sans contact

Boîtier compact en matière plastique à 2 composants, avec signal optique et acoustique, roulette d'allumage, éteignage et réglage commandable avec le pouce.

Comprobador sin contacto directo

Cuerpo compacto de plástico de 2 componentes, con señal óptica y acústica, ruedecilla para adaptación al voltaje a comprobar y las condiciones específicas.



Berührungsloses Erkennen von spannungsführenden Leitern, z.B. Kabel, Steckdosen, Verteiler, Anschlussdosen etc.
Lieferung erfolgt mit Batterien.

Contactless detection of live power lines, e.g. cables, power outlets, dividers, sockets etc.
Supplied with batteries.



Bestell-No./Order-No.	Art. No.	Volt - Volt		
50814280000	5081428	12 - 1000	50	1

5081265

Crimpzange

Profi Crimpzange mit Hebelübersetzung. Geschraubtes Gelenk, hohe Stabilität und gleichmäßiger Lauf. Hochfester Spezialstahl. Ergonomischer 2-K Griff für ermüdungsfreies Arbeiten. Zum Kabelschneiden, Abisolieren von Kabeln und Crimpen von isolierten und unisolierten Kabelschuhen und Steckverbindern. Top-Qualität, Multifunktion 5 in 1, Kapazität: 0,75 - 5,5 mm.

Crimping tool

Professional crimping tool with lever transmission. Bolted hinge, high stability and smooth operation. High-tensile special steel. Ergonomic 2K-handle for fatigue-proof working. For cutting of cables, stripping of wires and crimping of insulated/ non-insulated cable lugs and connectors. Premium quality, multifunction 5 in 1, Capacity: 0.75 - 5.5 mm.

VDE Kracht zijsnijtang

Professionele krimp tang met hefboom overbrenging. Geschroefd scharnier, hoge stabiliteit en gelijkmatige bediening. Hoogsterkte staal. Ergonomische 2-k greep voor comfortabel werken. Kabelschaar, verwijderen van kabelisolatie, Krimpen van geïsoleerde kabelschoentjes, Krimpen van ongeïsoleerde kabelschoentjes. Top kwaliteit, multifunctioneel 5 in 1, capaciteit: 0,75 - 5,5 mm.

Pince à sertir

Pince à sertir professionnelle avec effet de levier. Charnière boulonnée, grande stabilité et bon fonctionnement. Acier de haute résistance. Manche ergonomique à 2 composants pour travail antifatigue. Cutter de cables, dénudage des cables, sertissage des cosses de câble isolées, sertissage des cosses de câble non-isolées. Qualité top, multifonction 5 en 1, capacité: 0,75 - 5,5 mm.

Tenaza para terminales

Tenaza para terminales, calidad profesional con multiplicación de fuerza. Unión con tornillo, buena estabilidad y suave accionamiento. De acero especial. Mango ergonómico con fundas de 2 componentes para un trabajo sin esfuerzo. Cortacables, para pelar cables, para comprimir terminales con aislamiento, para comprimir terminales sin aislamiento. Calidad Premium, Multifunción 5 en 1, capacidad 0.75 - 5.5 mm.



Farbkodierte Querschnittzuordnung. Gewindelöcher zum Abschneiden von Gewindestiften. Colour coded coordination of cross section. Threaded holes for cutting of grub screws.

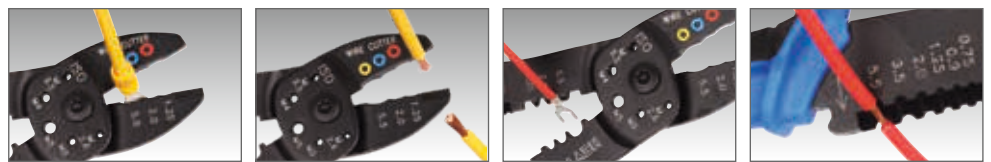

Bestell-No./Order-No.	Art. No.	CLD mm		
50812650000	5081265	200	270	1

5081267

249-tlg./pcs./-dlg./pces./pzs.

Crimpzangen-Set

Crimping tool-set

Krimptangen set

Assortiment pinces à sertir

Set de tenazas para terminales



enthaltend/containing

Isolierte Flachsteckhülsen Insulated Receptacles 10 St./pcs. AWG 22-16 / 16-14	Unisolierte Gabelkabelschuhe Non-Insulated Fork Terminals 40 St./pcs. AWG 22-16 / 12-10; M3 - M4 - M5	Gummi-Kabeldurchführungen Grommets 15 St./pcs. 3/16" - 1/4" - 3/8"
Isolierte Flachstecker Insulated Tabs (Spade Terminals) 10 St./pcs. AWG 22-16 / 16-14	Isolierte Ringkabelschuhe Insulated Ring Terminals 25 St./pcs. AWG 22-16 / 16-14 / 12-10; M3 - M4 - M5	Blindstecker Blind Plugs 5 St./pcs. AWG 22-16
Stoßverbinder Butt Connectors 40 St./pcs. AWG 22-16 / 16-14 / 12-10	Isolierte Gabelkabelschuhe Insulated Fork Terminals 25 St./pcs. AWG 22-16 / 16-14 / 12-10; M3 - M4 - M5	NiederspannungsAutosicherungen Low Voltage Car Fuses 20 St./pcs. 5/10/15/25 A
Unisolierte Ringkabelschuhe Non-Insulated Ring Terminals 40 St./pcs. AWG 22-16 / 16-14 / 12-10; M3 - M4 - M5	Kabelklemmen/Cable Clamps 10 St./pcs. 1/4" - 1/8"	Kabelschnellverbinder Quick Splice Connectors 8 St./pcs. AWG 22-16 / 16-14

Bestell-No./Order-No.	Art. No.	Maße · Dimensions		
50812670000	5081267	305 x 215 x 50 mm	930	1

50839 - VDE
DIN 3117



VDE Einmaulschlüssel,
verstellbar
Chrom-Vanadium, verchromt mit schutz-
isolierendem Griff nach DIN EN 60900 und
Skala.

VDE Adjustable wrench
Chrome-Vanadium, chromium plated,
insulated handle complying with
EN 60900 and scale.

VDE verstelbare moersleutel
Chroom-Vanadium, verchromd,
met geïsoleerde greep volgens
DIN EN 60900 en schaal aanduiding.

Clé à molette VDE
Chrome-Vanadium, chromé, avec poignée
isolée conforme norme EN 60900.

VDE llaves ajustables
Cromo Vanadio, cromado, con mango
para aislamiento según EN 60900
y Skala.



Bestell-No./Order-No.	Art. No.	mm	CLD "	MM/AF	g	
* 50839001088	50839 - VDE	255	10	0 - 30 0 - 1.1/4"	540	5

* Auslauf / Discontinued

5081221

Automatische Abisolierzange
Zum Abisolieren von Elektrodrähten,
Litzenleitern und Kabeln.

Automatic wire stripping plier
For stripping of electric wires, stranded
wires and cables.

Automatische kabelstriptang
Voor strippen van elctradraad en kabels.

Pince à dénuder automatique
Pour le dénudage de fils électriques, fils
torsadés et câbles.

Pinzas pelacables automáticos
Para pelar aâmbres elétricos,
conductores trenzados y cables.

Abisolierbereich PVC-isolierte Leiter 0,2 - 6 mm² Querschnitt,
einstellbare Abisolierlänge bis 18 mm, Drahtschneider bis 4 mm².
For PVC-insulated cables 0,2 - 6 mm² cross-section, adjustable
stripping plier up to 18 mm, perfect insulation trough automatic
adjustment to insulation thickness, with wire cutter up to 4 mm².



Bestell-No./Order-No.	Art. No.	CLD mm	g	
50812211900	5081221	200	390	1

5081668

Kabel-Klappmesser
Mit 2-K Griff, für schnelle Kabel- und
Drahtabisolierung, rostfreie Klinge.

Cable folding knife
With 2-K handle, for quick stripping of
cables and wires, blade of stainless steel.

Inklapbaar kabelmes
Met 2 componenten greep, voor snel
kabel- en draadstrippen, rvs lemmeet.

Couteau d'électricien
Bimatière, pour le dénudage rapide des
fils et câbles, lame en acier inoxydable.

Navajas de electricista
Para cables con 2 mangos componentes
para pelar los alambres y los cables de
forma rápida, hoja de acero inoxidable.



Bestell-No./Order-No.	Art. No.	CLD mm	g	
50816680000	5081668	115 - 195	75	1

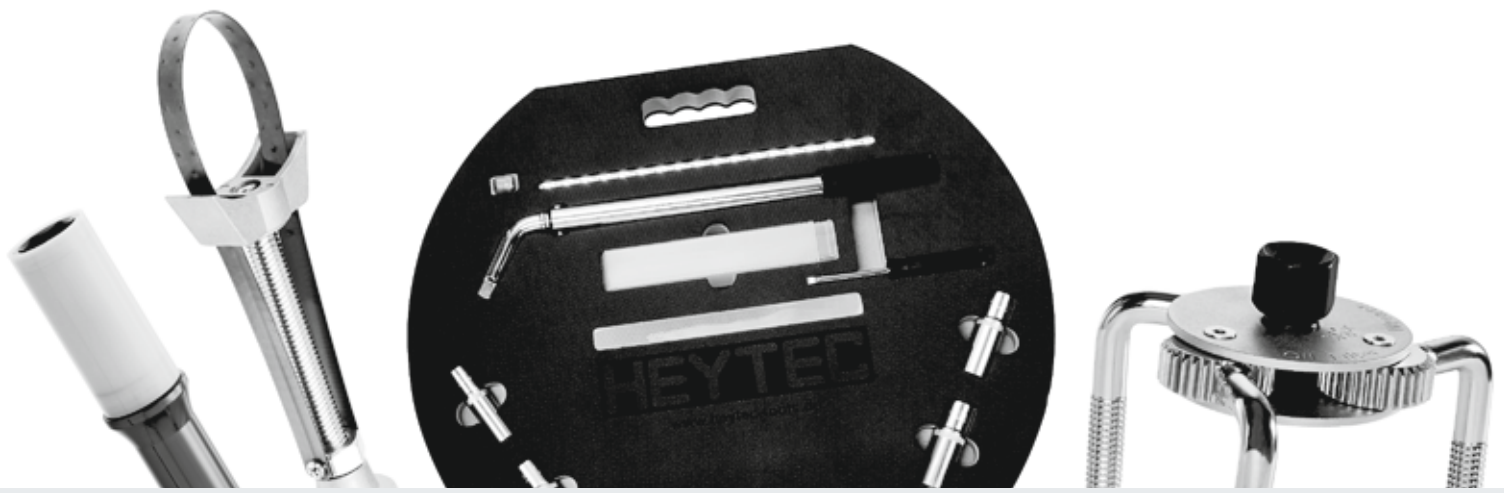

13 KAPITEL CHAPTER

KFZ-WERKZEUGE

AUTOMOBILE TOOLS

GEREEDSCHAP VOOR MOTORVOERTUIGEN

OUTILLAGE AUTOMOBILE

HERRAMIENTAS PARA AUTOMÓVILES

5082016

8-tlg./pcs./-dlg./pces./pzs.

Radwechsel-Werkzeugsatz

Für den schnellen und einfachen Radwechsel am PKW, zur Aufbewahrung in der Ersatzradmulde im Kofferraum.

Wheel changing tool set

For quick application to remove a tyre, insert for storage in the trunk.

Wielwessel gereedschapset

Gereedschapset voor het snel en eenvoudig wisselen van wielen bij personenauto's.

Kit démontage de roues



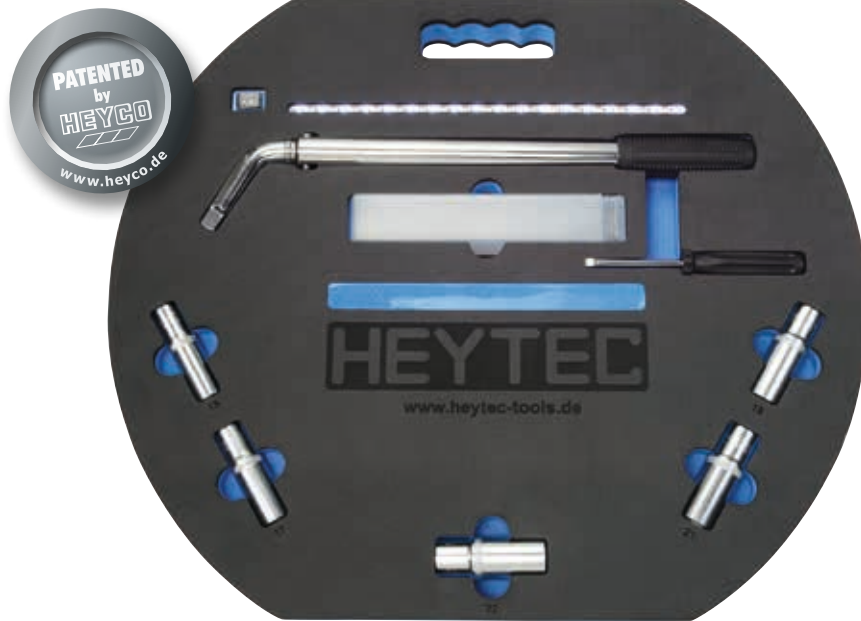

Kit pour changement rapide et facile de roues de voitures..

Juego de herramientas para cambio de rueda

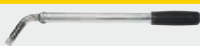

Facilita un cambio rápido de neumáticos, para guardar en el maletero.

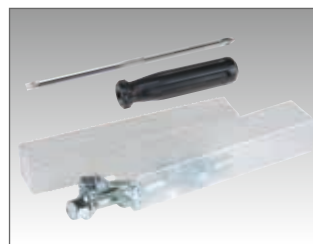
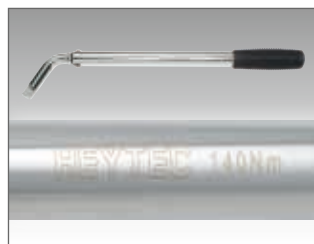

- Drehmomentschlüssel, Festwert 140 Nm, 1/2" - Antrieb
- Extra lange Steckschlüsseleinsätze, Chrom-Vanadium Stahl
- Aufbewahrungsbox leer, für Felgenschloss/Radschrauben
- Umsteckschraubendreher
- Lichtstreifen 18 LED mit Schalter, spritzwassergeschützt
- 4 Batterien 1,5 V AA inklusive
- Sicherheitsreflektor, beidseitig
- Integriertes Kniebrett
- Batteriefach rückseitig, spritzwassergeschützt
- Hochwertiger 2-K Schaumstoff
- Fixed torque wrench, 140 Nm, 1/2" drive
- Extra deep chrome Vanadium sockets
- Empty storage box for rim lock/wheel bolt
- Reversible screwdriver
- Light pad with 18 LED, splash-proof
- 4 batteries 1.5 V AA included
- Reflective strips on front/back side
- Integrated kneeboard
- Battery compartment on the back, splash-proof
- High grade 2 components foam

enthaltend/containing	
 CL ⇄ 410 mm	Drehmomentschlüssel / Torque wrench, 140 Nm
 CL ⇄ 75 mm	MM 15/17/19/21/22
 CL ⇄ 160 mm	+
 CL ⇄ 200 mm	Radmutterbox / Wheel nut box



Bestell.No./Order-No.	Art. No.	Maße · Dimensions		
* 50820160900	5082016	L 550 x B 470 x H 40 mm	2500	1

* Auslauf / Discontinued

5086300 - 5086300-19

Impact-Steckschlüssel

Chrom-Molybdän-Stahl, mit Kunststoffhülse und Kunststoffeinsteck zum Schutz von Alufelgen. Mit Kugelfangrinne und Bohrung, für Hand- und Schlagschraubetrieb.

Impact sockets

Chrome-molybdenum steel for protection of alloy wheels, with ball retaining groove and bore hole for manual operation or impact and power driven tools.

Krachttop

Chroom-Molybdeenstaal, met kunststof huls en kunststof inleg ter bescherming van aluminium velgen met kogelvanggroef en boring, hand- en slagschroevendraaiergebruik.

Douilles impact

Chrome-Molybdène, avec gaine plastique de protection des jantes en aluminium, avec élément de retenue de la bille, pour utilisation à main et à choc.

Llaves de vaso de impacto

Acero al cromo molibdeno, con protectores de plástico para no dañar llantas de aluminio, con ranura y agujero para su fijación, para apriete manual y a máquina.



5086300



5086300-19



Bestell-No./Order-No.	Art. No.			mm			
50863001760	5086300	17	85	216	1		
50863001960	5086300	19	85	227	1		
50863002160	5086300	21	85	255	1		

Bestell-No./Order-No.	Art. No.			mm			
50863191760	5086300-19	17	150	375	1		
50863191960	5086300-19	19	150	400	1		
50863192160	5086300-19	21	150	440	1		

Impact-Steckschlüsselsatz

Impact sockets set

Kracht dopsleutelset

Composition de douilles impact

Llaves de vaso de impacto

5086300-3

3-tlg./pcs./-dlg./pces./pzs.

Mit Kunststoffhülse in Box.

In box, with plastic sleeves and plastic inserts.

Met kunststof hulzen in box.

Avec gaine plastique en boîte.

Con protectores de plástico, en estuche.



Bestell-No./Order-No.	Art. No.			mm			
50863000300	5086300-3	17/19/21	85	820	1		

5086300-19-3

6-tlg./pcs./-dlg./pces./pzs.

Mit Kunststoffhülse in Box, extra lang für Tiefbetfelgen, SW 17, 19, 21 mm + 3 Ersatz Kunststoffschonhülsen.

In box, including, 3 spare sleeves, extra long for full drop center rims, 17, 19, 21 mm.

Met kunststof hulzen in box, extra lang voor brede velgen SW 17, 19, 21 mm + drie reserve kunststof hulzen.

Avec gaine plastique en boîte, extralongues pour jantes à base creuse 17, 19, 21 mm et 3 gaines plastiques de rechange.

Con protectores de plástico, en estuche, extra largas para llantas con asientos de tornillo profundos, bocas exagonales de 17, 19 y 21 mm, con 3 protectores de plástico de recambio.



Bestell-No./Order-No.	Art. No.			mm			
50863190300	5086300-19-3	17/19/21	150	1460	1		

50801329

Ø 65-120 mm

Ölfilterspinne

Spezialstahl, geschmiedete Ausführung, Oberfläche verzinkt, universell zu verwenden, für 1/2" und 3/8" Antriebe, SW 22, rechts + links Lauf.

Self-gripping oil filter wrench

Special steel, forged pattern, zinc plated for 3/8" and 1/2" square drive, SW 22.

Oliefiltertang

Speciaalstaal, gesmede uitvoering, opervlakte verzinkt, universeel toepasbaar, voor 1/2" en 3/8" aansluiting, SW 22, rechts en links draaiend.

Croisillon pour filtre à huile

Acier spécial, modèle forgé, surfaces galvanisées, utilisation universelle, pour entraînements 1/2" et 3/8", SW 22.

Filtro de aceite araña

Acero especial, modelo de acero forjado, superficie galvanizada uso universal para accionamiento de 1/2" y 3/8", SW 22.

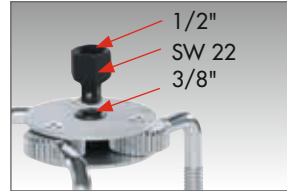

Bestell-No./Order-No.	Art. No.		
50801329080	50801329	563	1

5081500

Montiereisen

Mit auswechselbarer Kunststoffschiene. Die auswechselbare Kunststoffschiene schützt Aluminium- und lackierte Felgen vor Beschädigung.

Tyre lever

The exchangeable plastic cover protects aluminium and painted wheels from damage. The exchangeable plastic cover protects aluminium and painted wheels from damage.

Bandenlichter

Met verwisselbare kunststof beschermkap. De verwisselbare kunststof kap beschermt aluminium en gelakte velgen tegen beschadigingen.

Démonte-pneus

Avec gaine plastique amovible. La gaine en plastique amovible protège les jantes alu et en tôle.

Desmontable

ACon regla de plástico intercambiable. La regla de plástico protege llantas de aluminio o pintadas de raspaduras.



Bestell-No./Order-No.	Art. No.	Ø mm		
50815003880	5081500	380	415	1
50815005080	5081500	500	775	1

5081501

Ersatzschiene für Montiereisen

Spare cover for tyre lever

Beschermkappen voor bandenlichters

Gaine plastique de rechange pour démonte-pneus

Regla de recambio para desmontable



Bestell-No./Order-No.	Art. No.	Ø mm		
50815013800	5081501	380	55	1
50815015000	5081501	500	105	1

50801329

Ø 65-120 mm

Ölfilter-Bandschlüssel

- Stufenlos verstellbar durch Drehknopf
- Stahlband auswechselbar
- Kompakte Bauform

Geeignet zum Lösen und Festziehen von Ölfiltern. Speziell für enge und schwer zugängliche Bereiche.

Oil filter strap wrench

- Infinitely adjustable with rotary knob
- Replaceable steel strap
- Compact design

Suitable for loosening and tightening oil filters. Especially for narrow and hard-to-reach areas.

Oliefiltersleutel

- Traploos verstelbaar door draaiknop.
- Vervisselbare stalen band.
- Compacte bouwvorm.

Geschikt voor vast en losmaken van oliefilters. Speciaal voor nauwe en moeilijk bereikbare plekken.

Clé à sangle pour filtre à huile

- Réglable en continu par bouton rotatif
- Bande d'acier interchangeable
- Forme compacte

Geeignet zum Lösen und Festziehen von Ölfiltern. Speziell für enge und schwer zugängliche Bereiche.

Llave de correa para filtro de aceite

- Ajuste continuo mediante botón giratorio
- Banda de acero reemplazable
- Diseño compacto

Adecuada para aflojar y apretar filtros de aceite. Especialmente para zonas estrechas y de difícil acceso.



Bestell-No./Order-No.	CLD mm		
50801329100	210	210	1



14 KAPITEL CHAPTER

BAU-WERKZEUGE

CONSTRUCTION TOOLS

BOUWGEREEDSCHAPPEN

OUTILS DE CONSTRUCTION

HERRAMIENTAS DE CONSTRUCCIÓN

Gerüstbauknarre

Scaffolding ratchet

Werfpuntratel

Cliquet pour échafaudage avec arrache-clous

Carraca de andamio con extractor de clavos

50740

Das Ende des Handgriffs ist als Dorn ausgeführt und ermöglicht somit ein schnelles Justieren der Bauteile.

With „rat-tail“ handle for aligning construction parts.

Uitgevoerd met centreerpunt voor het snel justeren van boutgaten.

L'extrémité de la poignée est conçue en forme de pointe et permet ainsi un ajustement rapide des éléments à assembler.

El mango termina en cono para un ajuste rápido de los elementos del andamio. Bolso de cinturón.

50742

mit Nagelzieher

Mit integriertem ausklappbarem Nagelzieher. Das Ende des Handgriffs ist als Dorn ausgeführt und ermöglicht somit ein schnelles Justieren der Bauteile, umschaltbar.

with nail puller

With integrated fold-out nail puller. With rat-tail handle for aligning construction parts, reversible

met spijkertrekker

Met geïntegreerde, uitklapbare spijkertrekker. Het einde van de greep is als doorn uitgevoerd en maakt snel uitlijnen van bouwdeelen mogelijk, schakelbaar.

avec arrache-clous

Avec arrache clous pliable intégré. L'extrémité de la poignée est conçue en forme de pointe et permet ainsi un réglage rapide des composants, réversible.

con extractor de clavos

Con extractor de clavos plegable integrado. El mango termina en cono para el alineamiento rápido de los elementos del andamio, reversible.

50743

mit Nagelzieher

Chrom-Vanadium
Vielseitig einsetzbar, inklusive Nagelzieher und Hammer am Kopf, gesenkgeschmiedet, umschaltbar.

with nail puller

Chrome vanadium
Versatile in use, including nail puller and hammer at the head, drop-forged, reversible

met spijkertrekker

Chroom-vanadium
Veelzijdig gebruik, inclusief spijkertrekker en hamer op de kop, gesmeed, omkeerbaar.

avec arrache-clous

Chrome vanadium
Utilisable de manière polyvalente, y compris arrache-clou et marteau sur la tête, forgé à la matrice, réversible.

con extractor de clavos

Cromo vanadio
Versátil en su uso, incluye sacaclavos y martillo en la cabeza, forjado, reversible.

Chrom-Vanadium, verchromt.
Extrem stabile Modelle, mit Umschaltknarre und einem Durchlass für den Gewindebolzen.

Chrome-Vanadium, chromium plated.
Extremely robust products with reversible ratchet and pass-through feature for threaded bolts.



Bestell-No./Order-No.	Art. No.	CLØ mm	ØMM	g	Stk
50740192236	50740	315	19 x 22	435	2



Bestell-No./Order-No.	Art. No.	CLØ mm	ØMM	g	Stk
50742192280	50742	315	19 x 22	500	2



Bestell-No./Order-No.	Art. No.	CLØ mm	ØMM	g	Stk
50743192280	50743	315	19 x 22	570	2

50812453100

Drillapparat

- zum Verdrillen von Seilen und Drähten
- besonders geeignet zum Rödeln von Beton-Stahlbewehrung
- mit automatischem Rücklauf

Automatic Wire Twister

- for twisting wires and ropes
- specifically suitable for twisting of concrete reinforcement
- with automatic return

Zakkensluiter

- voor het draaien van touwen en draden
- Bijzonder geschikt voor het walsen van beton-staal wapening
- met automatische terugloop

Semoir

- pour torsader les câbles et les fils métalliques
- convient particulièrement pour relier les fils du béton armé
- avec recul automatique

Aparato de perforación

- para retorcer alambres y cuerdas
- especialmente adecuado para la torsión de armaduras de hormigón
- con retorno automático

NEU
NEW



Bestell.-No./Order-No.	Ø mm	g	mm
50812453100	310	420	1

88104

3-tlg./pcs./-dlg./pces./pzs.

Gerüstbauer-Werkzeugsatz

- Inklusive Halterung für Gerüstbauknarren
- Ideal für Zimmerleute und Gerüstbauer
- Angenehmer Tragekomfort durch rückseitige Polsterung

Scaffolding tool set

- Including holder for scaffolding ratchets
- Extremely robust products with reversible ratchet and pass-through feature for threaded bolts

Steigerbouw gereedschapset

- Met houder voor werfpunratel
- Ideaal voor timmerlui en steigerbouwers
- Aangenaam draagcomfort door polstering aan de achterzijde

Jeu d'outils pour échafaudeurs

- Support pour cliquet d'échafaudage inclus
- Idéal pour les charpentiers et les monteurs d'échafaudages
- Agréable à porter grâce au rembourrage au dos

Kit de herramientas para andamios

- Incluye soporte para trinquetes de andamio
- Con hebilla de seguridad para el cinturón
- Gran comodidad gracias al acolchado en la espalda



NEU
NEW

- Mit schwenkbarem Stahlbügel
- Tasche aus hochwertigem Polyester
- Mit Sicherungsschnalle für den Gürtel

- with swivelling steel clevis
- made from hard-wearing nylon
- Bag with safety buckle for the belt

- Met zwenkbare stalen beugel
- Uit hoogwaardig nylon
- Met veiligheidskoord voor de riem

- Avec poignée pivotante en acier
- Sac en polyester de haute qualité
- Avec boucle de sécurité pour la ceinture
- Con soporte de acero pivotante
- Bolsa fabricada en poliéster de alta calidad
- Ideal para carpinteros y andamios

enthaltend/containing



315 mm
Ø 19 x 22



330 mm
600 g



280 x 170 x 90 mm



Bestell.-No./Order-No.	Maße · Dimensions	Ø mm	g	mm
88104001200	280 x 170 x 90	19 x 22	1575	1

50745

4 in 1 Gerüstbauknarre

4 in 1 Scaffold ratcheting wrench

4 in 1 Werfpunratel

Cliquet pour échafaudage

4 en 1

Carraca de andamio 4 en 1

NEU
NEW



- Chrom-Vanadium, umschaltbar, Schaft geschmiedet
- Chrome vanadium, reversible, forged shaft
- Chroom vanadium, schakelbaar, gesmede schacht
- Chrome vanadium, réversible, tige forgée
- Cromo vanadio, reversible, eje forjado



Bestell.-No./Order-No.	Art. No.	Ø mm	MM	g	mm
50745142280	50745	290	14/17/19/22	540	1

50744

Gerüstbauschlüssel

- Chrom-Vanadium
- für die Montage von Gerüsten
- schwere Ausführung
- durch die abgerundeten Kanten liegt er besonders gut in der Hand
- hohe Festigkeit und Belastbarkeit

Double ended ring wrench

- Chrome vanadium
- for the assembly of scaffolding
- Heavy-duty design
- due to the rounded edges it lies particularly well in the hand
- high strength and resilience

Ringsleutel voor steigerbouw

- Chrom vanadium
- voor de montage van steigers
- Zwaar ontwerp
- De afgeronde hoeken maken het bijzonder comfortabel om vast te houden
- Hoge sterkte en draagkracht

Clé d'échafaudage

- chrome vanadium
- pour le montage d'échafaudages
- modèle lourd
- grâce à ses bords arrondis, elle tient particulièrement bien dans la main
- grande solidité et capacité de charge

Llave de andamio

- Cromo vanadio
- para el montaje de andamios
- Diseño resistente
- gracias a sus bordes redondeados, se adapta especialmente bien a la mano
- alta resistencia y elasticidad

NEU
NEW



Schwere Ausführung, 100% mehr Material, dadurch besonders langlebig (im Vergleich: ein herkömmlicher Dopperringenschlüssel wiegt ca. 300 gr., der Gerüstbauschlüssel liegt bei 630 gr., die Stärke des Halses liegt bei 14 mm im Vergleich zu 7 mm bei einem Standard Dopperringenschlüssel)

Heavy-duty design, 100% more material, thus particularly durable (in comparison: a standard double ring spanner weighs approx. 300 gr., the scaffolding spanner is 630 gr., the thickness of the blade is 14 mm compared to 7 mm for a standard double ring spanner)

Zwaar ontwerp, 100% meer materiaal, daarom bijzonder duurzaam (in vergelijking: een conventionele dubbele ringsleutel weegt ca. 300 g, de steigersleutel is 630 gr, de dikte van de steel is 14 mm ten opzichte van vergeleken met 7 mm met een standaard dubbele ringsleutel)

Modèle lourd, 100% plus de matériel, donc particulièrement durable (en comparaison: une clé à double anneau traditionnelle pèse environ 300 gr., la clé d'échafaudage est de 630 gr., l'épaisseur du brin est de 14 mm contre 7 mm pour une clé à double anneau standard)

Diseño resistente, 100% más material, por lo tanto especialmente duradera (en comparación: una llave estándar de doble anillo pesa aprox. 300 gr., la llave para andamios es de 630 gr., el grosor de la hoja es de 14 mm frente a los 7 mm de una llave estándar de doble anillo)

Bestell-No./Order-No.	Art. No.	Ø mm	mm	g	
50744212280	50744	325	21 x 22	630	1

50740

Sicherheitsleine für Werkzeuge

Aus strapazierfähigem Nylon, 2-fache Sicherheitshaken aus Aluminium. ANSI/ISEA 121:2018 konform. Belastbar bis 4,5 kg / 10 lbs.

Safety leash for tools

Made of durable nylon, 2-fold aluminium safety hooks. Conform to ANSI/ ISEA 121:2018. Resilience up to 4.5 kg / 10 lbs.

Vanglijn voor gereedschap

Gemaakt van slijtvast nylon, 2 aluminium veiligheidshaken aluminium veiligheidshaken. Voldoet aan ANSI/ ISEA 121:2018. Belastbaar tot 4,5 kg.

Câble de sécurité pour outils

En nylon résistant, 2 crochets de sécurité en aluminium. Conforme à la norme ANSI/ISEA 121:2018. Peut supporter jusqu'à 4,5 kg / 10 lbs.

Cabo de seguridad para herramientas

De nylon resistente, ganchos de seguridad de aluminio de 2 pliegues. Conforme a ANSI/ ISEA 121:2018. Resistencia hasta 4,5 kg / 10 lbs.

NEU
NEW

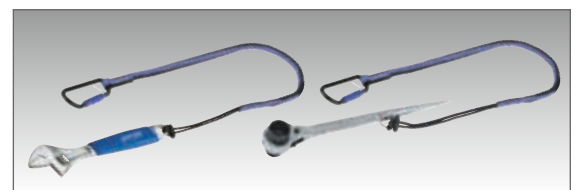

Bestell-No./Order-No.	Art. No.	Ø mm	bis kg/lbs	g	
50740109000	50740	900 - 1400	4,5 / 10	80	1

50815770900
50815771200

Hebel- und Montageeisen

Aus Spezial-Werkzeugstahl für maximale Beanspruchung: Das innovative Oval Doppel-T Profil bietet höchste Festigkeit und einen festen und sicheren Griff. Gewalzte Struktur, geschmiedete Enden.

Pry bar

Made from special tool steel for heavy-duty applications: The innovative, oval double-T profile provides highest strength and a particularly safe and secure grip. Forged steel, rolled structure, forged ends.

Koevoet

Uit speciaal gereedschapsstaal voor zware toepassingen: het innovatieve, ovale dubbele T-profiel biedt de grootste kracht en stevige grip. Gewalste structuur, gesmede uiteinden.

En acier à outils spécial pour un maximum de sollicitation: l'innovant ovale profilé en double T offre une résistance et une prise ferme et sûre. Structure laminée, extrémités forgées.

Palanca y plancha de montaje

Fabricado en acero especial para herramientas, para una máxima durabilidad. El innovador perfil ovalado en doble T ofrece la máxima resistencia y un agarre firme y seguro. Estructura laminada, extremos forjados.

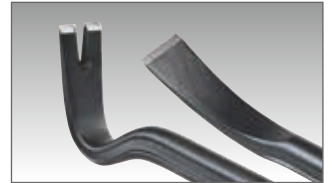

Präzises und sicheres Arbeiten: Die Form der geschmiedeten Enden garantiert hohe Festigkeit und Hebelwirkung, vor allem geeignet für enge Spalten und Bauräume. Besonders geeignet für Demontage, Abriss, Beton-, Straßen- und Schienenbau – für maximale Hebelkräfte und Belastungen.

For ultra-heavy-duty applications: The shape of the forged tails guarantees high strength and leverage, especially suitable for use in narrow gaps and tight spaces. Particularly suitable for dismantling and demolition work and in concrete, road and railway construction. Suitable for maximum leverage and strain.



Bestell-No./Order-No.	mm	CLD	"	g	mm
50815770600	600 mm		24"	1980	6
50815770900	900 mm		36"	2990	6
50815771200	1200 mm		48"	4130	6

5081839-3

Bandmaß, 3 m

ABS Kunststoff Gehäuse. Softgrip Gummibeschichtung für sicheren Halt. Magnetischer Endhaken, verschiebbar für Innen- und Außenmessung. Stopfunktion. Gürtelclip. Handschlaufe.

Measuring tape, 3 m

ABS plastic housing. Softgrip rubber coating for a secure grip. Magnetic hook, moveable for internal and external gauging. Stopping function. Belt clip. Hand strap.

3 meter rolbandmaat

ABS kunststof huis. Softgrip rubberen mantel voor stevige grip. Magnetische haak, verstelbaar voor binnen- en buitenmeting. Stopfunctie. Riemclip. Polskoord.

Mesure de poche, 3 m

Boîtier en plastique ABS revêtu softgrip pour une bonne prise en main. Crochet magnétique, réglable pour mesure intérieure et extérieure. Fonction d'arrêt. Clip ceinture.

Flexómetro de 3 metros

Caja de plástico ABS. Recubierto de goma blanda para un agarre seguro. Gancho imantado ajustable para medición interior y exterior. Función de parada. Clip para el cinturón. Con asa para colgar de la muñeca.



Bestell-No./Order-No.	Art. No.	Messbereich · Measuring range	g	mm
50818393000	5081839-3	3 m	125	1
* 50818393200	5081839-12	3 m	1500	12

*Lieferung im Verkaufsdisplay • Delivery in sale display

5081730

Stirnleuchte mit LED-Licht

3 Helligkeitsstufen schaltbar, zusätzlich Blinklicht bei Volllicht, verstellbare elastische Haltebänder, inkl. Batterien.

LED Headlamp

3 lighting degree, as well winking at full intensity, adjustable elastic support, incl. batteries.

Hoofdlamp met LED licht

3 lichtsterktes instelbaar, knipperfunctie bij volledige sterkte, verstelbare, elastische helmband, inkl. Batterien.

Lampe frontale „LED“

3 intensités d'éclairage, en plus, lumière clignotante en position maximale, support élastique réglable. Piles incluses.

Linterna para casco LED

3 intensités d'éclairage, fonction clignotant en position maximale, sangles élastiques réglables, piles incluses.



Lieferung ohne Helm
Delivery without safety helmet
Levering zonder helm
Livrée sans casque de chantier
Suministro sin casco



5081835

Wasserwaage

Aus 2-K Kunststoff mit Schutz durch Weichkomponente und Aluminiumsockelleiste, magnetisch, für eine exakte Auflage.

Spirit Level

Made of 2-K plastic protected through soft component and aluminium base board, magnetic, plumb vial.

Waterpas

Van 2 componenten kunststof met bescherming door soft componenten en aluminium bodemstrip, magnetisch.

Niveau à bulle

En plastique à 2 composantes avec protection par matières souples et profil en aluminium, magnétique, pour un appui précis.

Nivel de agua

Hecho en plástico de dos componentes protegido mediante componente blando y rodapié de madera, magnético.

Bestell-No./Order-No.	Art. No.		
5081730000	5081730	120	1



Libellen für waagrecht, senkrecht und 45° Messungen. Prismatische Messfläche.
Horizontal vial, vial for 45° measurements, prismatic measurement surface.
Libel voor horizontale, verticale en 45° metingen prismatisch meetoppervlak.
Niveau à bulle d'air pour mesure horizontale, verticale et à 45°, surface de mesure prismatique.
Nivel de burbuja para mediciones en horizontal, vertical y en 45°, superficie de medición prismática.

Bestell-No./Order-No.	Art. No.		
5081835000	5081835	230	1

5081835-1

Wasserwaage, 400 mm

3 Libellen. Starkes Alu-Rechteckprofil mit Verstärkungsrippen, Pulverbeschichtung, Stoßdämpfende Endkappen und Messkala.

Spirit Level, 400 mm

3 vials. Strong aluminium rectangular profile with reinforcing fins, powder coating, shock-absorbing end caps and measurement scale.

Waterpas, 400 mm

3 libellen. Robuust aluminium kokerprofiel met versterkingsribben, poedercoating, schokabsorberende einkappen en maatverdeling.

Niveau à bulle, 400 mm

3 libellules. Profil rectangulaire renforcé par les rainures. Profil fort rectangulaire au nervures de renfort rectangulaire. Embouts anti-choc, avec graduation.

Nivel de agua, 400 mm

3 ampollas. Perfil rectangular robusto de aluminio, con nervios de reforzamiento, pintado en epoxy, topes de protección y escala de medición.



Bestell-No./Order-No.	Art. No.		
50818350100	5081835-1	400	1

50818360300

300 mm

Präzisions-Maßstab, 300 mm

Aus Aluminium, mit Aufhängeloch,
metrische und Zoll Skala.

Precision rule,
300 mm

Made of aluminium, with hanging hole,
metric and inch scale.

Maatlat,
300 mm

Van aluminium, met ophangoog,
metrische en inch maatverdeling.

Réglet de précision,
300 mm

En aluminium, avec perforation
d'accroche, échelle métrique et en pouce.

Regla de precision,
300 mm

Escala de aluminio, con agujero para
colgar, escala métrica y en pulgadas.



Bestell-No./Order-No.	CLD mm / "	Maße · Dimensions	g	1
50818360300	300 / 11,8	320 x 25 x 2 mm	30	1

5081836

Zimmermannswinkel

- Hochwertiger Zimmermannswinkel aus Aluminium mit Lineal aus rostfreiem Stahl
- Anschlagsschenkel mit Gehrung zum Anreißen von 45° und 90° Linien

Carpenter's square

- High-quality aluminium Carpenter's Square with stainless steel blade ruler
- Handle with integrated 45°-angle for easy marking of 45°- and 90°-lines

Schrijfhaak

- Hoogwaardige aluminium schrijfhaak met rvs lineaal
- Handgreep met geïntegreerde 45° hoek voor het eenvoudig aangeven van 45° en 90° lijnen

Equerre de menuisier

- Equerre de menuisier de haute qualité en aluminium avec règle en acier inoxydable
- Poignée intégrée angle 45° pour marquage facile de lignes à 45° et 90°

Escuadra de carpintero

- Aluminio de alta calidad, escuadra de carpintero con hoja de acero inoxidable
- Mango con ángulo de 45° integrado, para facilitar el marcado en 45° y 90°



Skalierung:
· Vorderseite in mm (300)
· Rückseite in Zoll (11,8)

Scale printing:
· Front in mm (300)
· Back in inches (11,8)

Praktische Bohrung zum Aufhängen (8 mm)
Blade with pin hole (8 mm)



Bestell-No./Order-No.	Art. No.	CLD mm / "	g	1
50818360000	5081836	300 / 11,8	250	1

5081052-5

50-tlg./pcs./-dlg./pces./pzs.

Dachdecker-Sortiment im Rucksack

Hochwertiger Rucksack mit separater Innentasche für Werkzeuge aller Art.

Slater assortment in backpack

High quality backpack with separate inner pocket for all kinds of tools.

Dakdekkers gereedschapset in rugzak

Hoogwaardige rugzak met apart binnenvak voor diverse gereedschappen.

Assortiment pour couvreur en sac à dos

Sac à dos de haute qualité avec poche intérieure séparée pour toute sorte d'outils.

Juego de herramientas para trabajos en tejados



Mochila de alta calidad con bolsillo interior separado para herramientas de todo tipo.



enthaltend/containing

-  5 m
-  195 - 570 mm
-  230 mm
-  200 mm
-  260 mm
-  400 mm
-  200 mm
-  200 mm
-  200 mm / 8"
-  400 mm
-  Geprüft nach DIN EN 166 F
-  CE/EN 388-4131
-  Gr. 18 mm
-  600 g
-  300 mm / 11,8"
-  17+22er Zahnung
teeth per inch
-  315 mm
Ø 19 x 22
-  



Bestell-No./Order-No.	Art. No.	Maße · Dimensions		
50810525000	5081052-5	460 x 350 x 180 mm	8100	1



15 KAPITEL CHAPTER

ALLGEMEINER WERKSTATTBEDARF

PRODUCTS FOR WORKSHOP

WERKPLAATS BENODIGDHEDEN

FOURNITURES GÉNÉRALES D'ATELIER

SUMINISTROS PARA TALLERES

5082250

Multifunktions-Abziehersatz

In Kunststoffbox. Grundplatte aus Spezialguß, Abzugsarme und Spindel aus Chrom-Molybdän-Stahl, verwendbar als 2- und 3-armige Innen-/Außenabzieher in 8 Varianten, Belastung als 2-armiger Abzieher: 25000 N - VPA getestet.

Multifunction pullers

In plastic box. Bridge made of special cast iron, puller legs and screw axis made of chrom-molybdenum, usable in 8 options with 2 or 3 legs for internal or external applications stability under load: 25000 N - VPA tested.

Multifunctionele trekkerzet

In kunststof koffer. Brug van speciaal gietijzer, haken en spindel van chrom-molybdeenstaal, te gebruiken als 2- en 3-armige binnen-/buitentrekker in 8 varianten belasting als 2-armige trekker: 25000 N - VPA getest.

Jeu d'extracteurs multifonctions

En coffret plastique. Support en fonte spéciale, bras extracteurs et axe en acier au chrome-molybdène, utilisable en 8 variantes avec 2 ou 3 bras en prise extérieure ou intérieure, stabilité sous charge 25000 N - Testé VPA.

Juego de extractores multifunción

En estuche de plástico. Placa base de fundición especial, brazos y husillo de acero al cromo molibdeno, sirve como extractor interior y/o exterior de 2 y 3 brazos en 8 variables. Estabilidad bajo carga como extractor de dos brazos verificado VPA - 25000 N.



Patentierte Rasterfunktion
Patented notching function

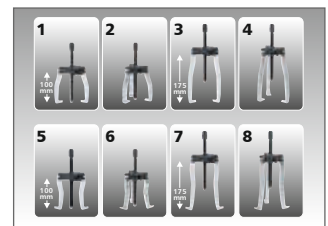

1 Abzieherbrücke
1 Gewindespindel
Je 3 Abzieharme

1 Support bridge
1 Screw axis
Each 3 puller legs

1 Trekkerbrug
1 Draadspindel
elk 3 trekhaken

1 Portique de support
1 Axe fileté
3 bras extracteurs de chaque

1 Puente de amarre
1 Husillo
3 brazos de extracción de cada

Bestell-No./Order-No.	Art. No.		
50822500780	5082250	2635	1

5081490

16-tlg./pcs./-dlg./pces./pzs.

HSS-Gewindeschneidsatz

Chrom-Vanadium, verchromt, in Metallkasten, mit 2-K Schaumstoffeinlagen.

HSS Die cutting set

Chrome-Vanadium, chromium plated, in metal case, with 2 components foam inserts.

HSS tap- en draadsnijset

Chroom-Vanadium, verchromd, in metalen kist, met 2 componenten schuimvulling.

Coffret de filetage HSS

Chrome-Vanadium, chromées, en coffret métallique, avec intérieur mousse bicolore.

Set de rosca cortante de acero HSS

Cromo Vanadio, cromadas, en caja metálica con material de espuma 2 componentes alta gama.



Bestell-No./Order-No.	Art. No.	Maße - Dimensions		
50814900000	5081490	220 x 110 x 45 mm	435	1

Bestell-No./Order-No.	Art. No.	Maße - Dimensions		
50814922000	5081492-20	M3 - M10	149	1
50814912000	5081491-20	M3 - M8	52	1
50814913000	5081491-30	M5 - M10	83	1
50814910400	5081491-04	M4	5	1
50814910500	5081491-05	M5	6	1
50814910600	5081491-06	M6	10	1
50814910800	5081491-08	M8	16	1
50814911000	5081491-10	M10	23	1
50814920400	5081492-04	M4	26	1
50814920500	5081492-05	M5	26	1
50814920600	5081492-06	M6	24	1
50814920800	5081492-08	M8	22	1
50814921000	5081492-10	M10	20	1
50825018083	50825-00-18	1/4"	146	5

Ø 25 mm

Ersatzteile

Spare parts

Onderdelen

Pièces de rechange

Piezas de repuesto

5081720

Stablampe mit LED-Licht

Stufenlos ausziehbar, mit magnetischem Leuchtkopf, inkl. Batterien.

LED Torchlight

Progressively extensible, with lighting magnetic head, incl. batteries.

Zaklantaarn met LED licht

Traploos uitschuifbaar, met magnetische kop, incl. batterijen.

Lampe torche „LED“

Extensible, avec tête magnétique éclairante. Piles incluses.

Linterna LED

Extensible sin escalones, con cabezal luminoso magnético, incluyendo baterías.



Bestell-No./Order-No.	Art. No.	CLD mm	U	g	
5081720000	5081720	170 - 500	600 g	100	1

50817210300

Arbeitslampe

Zur optimalen Ausleuchtung von dunklen Arbeitsbereichen. Gehäuse aus ABS-Kunststoff mit gummierter Oberfläche für sicheren Halt in der Hand, inkl. Batterien (3 x AA 1,5 V).

Working lamp

For perfect illumination of dark areas, weight 200 g. ABS-plastic housing with rubberised surface, incl. batteries (3 x AA 1,5 V).

Werklamp

Voor het optimaal belichten van donkere werkplekken. Behuizing van ABS met rubberen oppervlak voor stevige grip, incl. batterijen (3 x AA 1,5 V).

Lampe d'atelier

Pour un éclairage optimal des coins sombres. Boîtier en ABS avec revêtement soft grip pour une meilleure haptique. Piles incluses (3 x AA 1,5 V).

Lámpara de trabajo

Para una iluminación óptima de las zonas de trabajo oscuras. Carcasa de plástico ABS con superficie de goma para un agarre seguro en la mano, incluye pilas (3 x AA 1,5 V).



180° schwenkbare Griffstück, selbstarretierend. Starker Magnet am Fußteil. Umschaltbar von Haupt- auf Frontlicht. COB LED Hauptlicht (400 lm)/ SMD LED Frontlicht (120 lm).

180° draaibare handgreep, zelfvergrendelend. With strong magnet, top and main light. COB LED main light (400 lm)/SMD LED top light (120 lm).

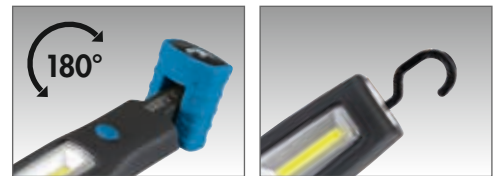

Bestell-No./Order-No.	Maße · Dimensions	g	
50817210300	220 x 55 x 32 mm	200	1

5081732

CE/EN 352-1 2003

Kapsel-Gehörschutz

Hoher Dämmwert SNR 30 dB. Einfaches Anpassen an jede Kopfform durch vielfältige Verstellmöglichkeiten. Kompakt zusammenfaltbar für einfachen Transport.

Foldable ear muff

High attenuation SNR value 30 dB. Easy adaption to any head shape by versatile adjustability. Compactly foldable for easy transport.

Gehoorbekkermer

Hoge demping SNR 30 dB. Eenvoudig in grootte aanpasbaar dankzij de vele verstelmogelijkheden. Compact opvouwbaar voor eenvoudig transport.

Protecteur auditif

Valeur d'isolation élevée SNR 30 dB. Facile à adapter à n'importe quelle forme de tête grâce à un ajustement multiple. Se plie de manière compacte pour un transport facile.

Cascos de protección del oído

Alto valor aislante SNR 30db. Fácil adaptación a cualquier forma de cabeza, gracias a múltiples posibilidades de ajuste. Plegable para facilitar su transporte.

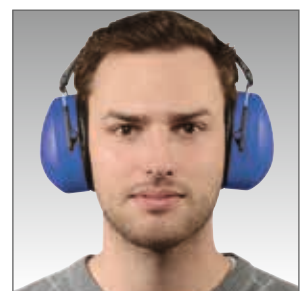

Kunstleder Kopfband. Kunstleder gepolsterte Ohrmuschel. PVC headband. Ear cups with soft PVC cushions.

Bestell-No./Order-No.	Art. No.	g	
50817320000	5081732	240	1

5081731

DIN EN 166 F

Schutzbrille

Protective glasses

Veiligheidsbril

Lunettes de protection

Lafas protectoras



Bestell-No./Order-No.	Art. No.			
50817310000	5081731		70	1

5081733

CE/EN 388-4131

Arbeitshandschuhe

Aus atmungsaktivem, strapazierfähigem Nylonmaterial. Handinnenflächen Nitril Schaum beschichtet. Hervorragende Beständigkeit gegen Öle und Fette.

Protective gloves

Made of breathable, sturdy nylon material. Palms coated with nitrile foam. Excellent resistance to oil and grease.

Werkhandschoenen

Van ademend, duurzaam nylon. Voorzien van Nitril coating. Uitstekend bestand tegen oliën en vetten.

Gants de travail

En nylon durable et respirant. Paume enduite de nitrile. Excellente résistance contre les matières grasses.

Guantes de trabajo

De nylon, transpirables y resistentes. Superficies en la palma, recubiertas de espuma de nitrilo. Resistente a aceites y grasas.

EN 388



4131



Ausgezeichnete Passform. Sehr gutes Tastempfinden. Hohe Griffsicherheit bei Feuchtigkeit. Excellent fit. Very good sense of touch. Providing good grip under humid working conditions.

Bestell-No./Order-No.	Art. No.	Größe - Size		
50817330800	50817-33-08	8"	30	12
50817330900	50817-33-09	9"	30	12

5081734

CE/EN 388-2131x, DIN 388

Mechaniker

Arbeitshandschuhe

Aus atmungsaktivem, strapazierfähigem Mikrofaser. Handinnenflächen aus hochwertigem Kunstleder. Ausgezeichnete Passform und leichtes Tragegefühl.

Mechanic work gloves

Made from breathable, robust microfibre. Palms made from high-quality synthetic leather. Excellent fit and lightweight feel.

Monteurs-werkhandschoenen

Van ademend, duurzaam microvezel. Handpalmzijde van hoogwaardig kunstleer. Perfecte pasvorm en licht draaggevoel.

Gants de travail

pour mécaniciens
En microfibre respirante et résistante. Paume de la main en cuir synthétique de haute qualité. Excellente tenue et sensation de légèreté.

Guantes de mecánico

De microfibra transpirable y resistente. Palma de piel sintética de alta calidad. Excelente ajuste y sensación de ligereza.

NEU
NEW



Bestell-No./Order-No.	Art. No.	Größe - Size		
50817340800	50817-34-08	8/M	100	10
50817340900	50817-34-09	9/L	100	10
50817341000	50817-34-10	10/XL	100	10

16 KAPITEL CHAPTER

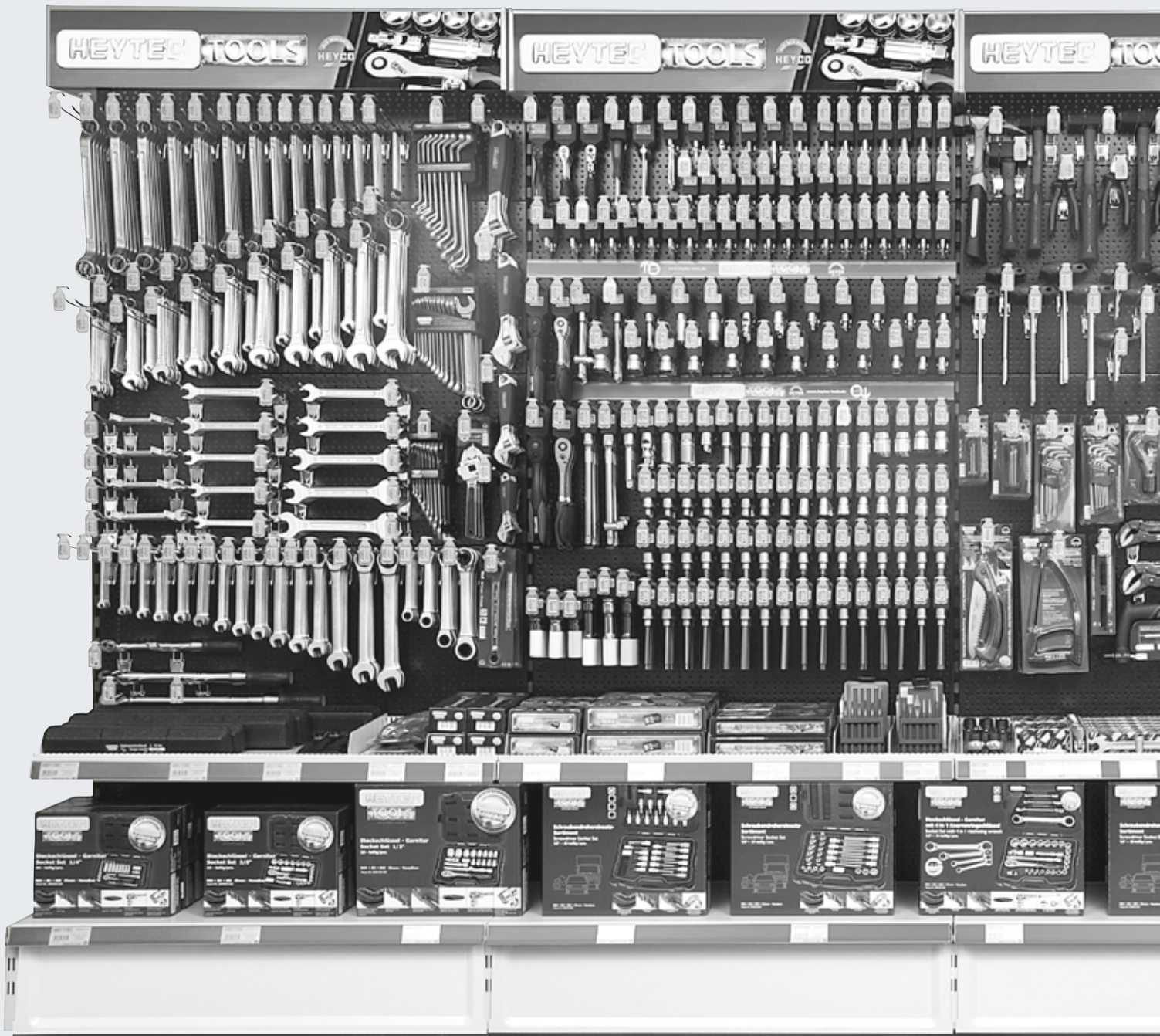

PRÄSENTATIONSSYSTEME
 PRESENTATION SYSTEMS
 PRESENTATIESYSTEMEN
 SYSTÈMES DE PRÉSENTATION
 SISTEMAS DE PRESENTACIÓN



**5 Bausteine
 für erfolgreiche Warenpräsentation:**

- Top-modisches Design
- Anschauliche Anwendungsbeispiele
- Herausgestellte Besonderheiten
- Bedarfsgerechte Bestückung
- Einheitliches Erscheinungsbild

**5 elements
 for successfull presentation:**

- Advanced design
- Examples for applications
- Exposed features
- Assortment as per market demand
- Consistent appearance

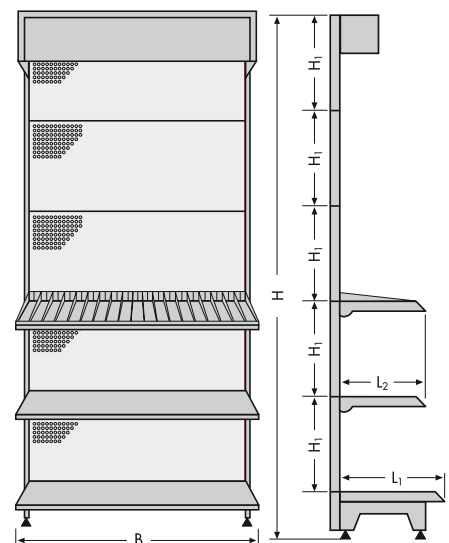

- B = 665 · 1000 · 1250 · 1333 mm
 H = 1410 · 1610 · 2010 · 2210 · 2410 mm
 H₁ = 400 mm
 L₁ = 570 mm
 L₂ = 250 · 300 · 370 · 470 mm



50880-1

Einsatzspender, leer

Zur Aufbewahrung und Präsentation von Steckschlüsseinsätzen und Schraubendrehereinsätzen aller Art. Variable Einteilung durch Trennsystem. Zusammenstellung von Sortimenten nach eigenem Belieben möglich.

Socket dispenser, empty

For storage and presentation of sockets. Variable system of partitions permits composition of different assortments to choice.

Dopsleuteldisplay, leeg

Voor het opbergen en presenteren van dopsleutels en schroevendraaierdopsleutels. Variabele indeling door verdeelschotten. Assortiment naar eigen wens samen te stellen.

Présentoir métallique, vide

Pour la présentation de douilles et douilles tournevis. Un système variable de cloisonnement permet des compositions différentes au choix.

Expositor combinado, vacío

Para el almacenamiento y presentación de llaves de vaso y vasos con destornillador. Separaciones ajustables por sistema de listones que permiten componer los surtidos a elección del usuario.

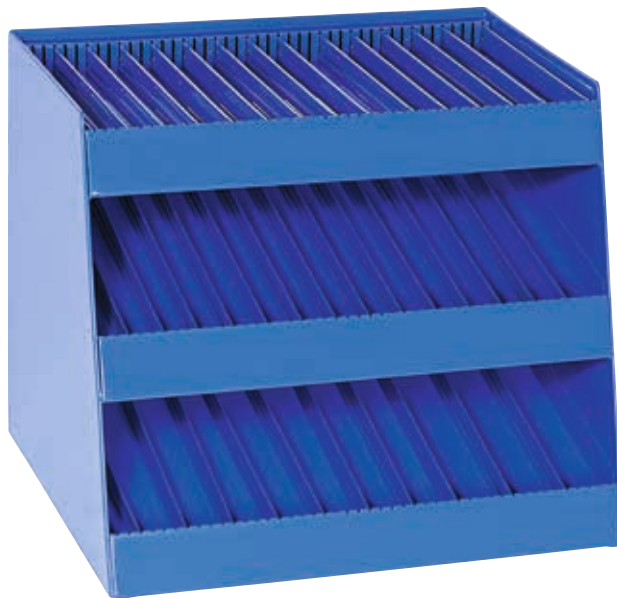

Bestell-No./Order-No.	Art. No.	Maße · Dimensions		
5088000020	50880-1	350 x 420 x 350 mm	9700	1

50825-65

1/4"

Einsatzspender

mit 1/4" Sortiment, 491-tlg.

Socket dispenser

with 1/4" assortment, 491 pcs.

Dopsleuteldisplay

met 1/4" assortiment, 491-dlg.

Présentoir équipé

avec assortiment 1/4", 491 pcs.

Expositor combinado

con 1/4" surtido, 491 pzs.



enthaltend/containing

je 10 Stk./pcs. MM 4/4,5/5/5,5/6/7/8/9/10/11/12/13	37 mm / je 10 Stk./pcs.
je 10 Stk./pcs. MM 6/7/8/9/10/11/12/13	50 mm / je 10 Stk./pcs.
je 10 Stk./pcs. E 4/5/6/7/8/10	100 mm / je 10 Stk./pcs.
je 10 Stk./pcs. 4/5,5	115 mm / je 10 Stk./pcs.
je 10 Stk./pcs. PH 1/2	150 mm / je 10 Stk./pcs.
je 10 Stk./pcs. PZ 1/2	150 mm / je 10 Stk./pcs.
je 10 Stk./pcs. MM 3/4/5/6	
je 10 Stk./pcs. TT 10/15/20/25/27/30/40	

Abbildung enthält Sonderausstattung · Picture shows extras

Bestell-No./Order-No.	Art. No.	Maße · Dimensions		
50825006583	50825-65	350 x 420 x 350 mm	21300	1



50850-65

1/2"

Einsatzspender

mit 1/2" Sortiment, 332-tlg.

Socket dispenser

with 1/2" assortment, 332 pcs.

Dopsleuteldisplay

met 1/2" assortiment, 332-dlg.

Présentoir équipé

avec assortiment 1/2", 332 pces.

Expositor combinado

con 1/2" surtido, 332 pzs.



enthaltend/containing

je 10 Stk./pcs.	MM 8/9/10/11/12/13/14/15/16	je 7 Stk./pcs.	MM 6/8/10/12/14
je 10 Stk./pcs.	MM 17/18/19/20/21/22/23/24/	je 7 Stk./pcs.	T 25/27/30/40/45
je 7 Stk./pcs.	27/30/32	je 7 Stk./pcs.	M 6/8/10/12
je 7 Stk./pcs.	E 10/11/12/14/16/18		

Abbildung enthält Sonderausstattung · Picture shows extras

Bestell-No./Order-No.	Art. No.	Maße · Dimensions		
50850006583	50850-65	350 x 420 x 350 mm	36600	1

50825-5065

1/4" + 1/2"

Einsatzspender

mit 1/4" + 1/2" Sortiment, 442-tlg.

Socket dispenser

with 1/4" + 1/2" assortment, 442 pcs.

Dopsleuteldisplay

met 1/4" + 1/2" assortiment, 442-dlg.

Présentoir équipé

avec assortiment 1/4" + 1/2", 442 pces.

Expositor combinado

con 1/4" + 1/2" surtido, 442 pzs.

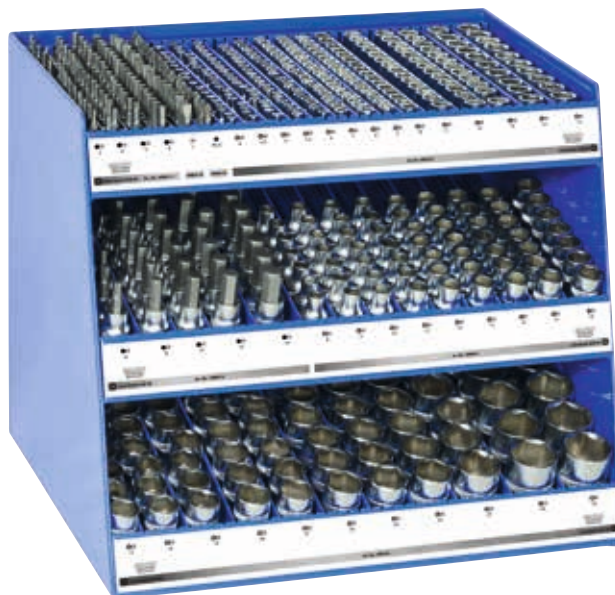

enthaltend/containing

je 10 Stk./pcs.	MM 4/4,5/5/5,5/6/7/8/9/10/11/12/13/14/15	je 10 Stk./pcs.	MM 8/9/10/11/12/13/14/15/16/17/18/19/20/21/22/23/24
je 10 Stk./pcs.	7	je 7 Stk./pcs.	27/30/32
je 10 Stk./pcs.	PH 2	je 10 Stk./pcs.	MM 6/8/10/12/14
je 10 Stk./pcs.	MM 3/4/5/6		

Abbildung enthält Sonderausstattung · Picture shows extras

Bestell-No./Order-No.	Art. No.	Maße · Dimensions		
50825506583	50825-5065	350 x 420 x 350 mm	33300	1

Nummernliste, Numerical list, Nummerlijst, Liste des references, Lista de referencias

Code	EAN 4024089 +	Code	EAN 4024089 +	Code	EAN 4024089 +	Code	EAN 4024089 +
01128110200	172041	50725022080	170030	50800131580	325829	50805202280	324280
50214500100	394252	50725024080	170047	50800131780	325836	50805212380	324297
50214500200	394269	50725027080	364903	50800141580	170634	50805242780	324303
50253320834	058260	50725030080	364910	50800161780	170641	50805252880	324310
50720008080	123869	50725032080	364927	50800161880	325843	50805303280	324327
50720009080	123852	50725600080	174571	50800171980	173680	50805420680	347494
50720010080	123845	50725600180	174588	50800181980	170658	50805420780	347500
50720011080	123838	50725600280	174953	50800192280	325850	50805420880	347517
50720012080	123821	50725600380	304428	50800202280	170665	50805420980	347524
50720013080	123814	50725600580	392944	50800212380	170672	50805421080	347531
50720014080	123807	50730081383	348224	50800242780	170689	50805421180	347548
50720015080	123791	50730091583	348231	50800252880	170696	50805421280	347555
50720016080	123784	50730101983	363166	50800273080	173673	50805421380	347562
50720017080	123777	50730161983	348248	50800303280	170702	50805425580	347487
50720018080	123760	50730202483	348255	50800323680	370652	50805429080	356267
50720019080	123753	50730600183	348262	50800330683	332353	50805644080	347654
50720022080	364866	50740109000	452204	50800364180	370669	50805747080	331844
50720024080	364873	50740192236	166941	50800414680	391428	50805944080	324334
50720027080	364897	50742192280	394047	50800644080	345902	50805947080	324341
50720600080	125818	50743192280	451238	50800747080	334012	50807694500	346633
50720600180	128895	50744212280	451221	50800844080	174168	50807696100	416282
50720600280	133394	50745142280	451245	50800944080	171198	50807696200	416275
50720600380	325560	50750010080	061956	50800947080	171181	50807740100	416244
50725008080	169911	50750010080	061956	50801329080	364859	50807740200	416237
50725009080	169928	50750010180	061963	50801329100	417869	50807740300	416220
50725010080	169935	50750010180	061963	50805060780	324204	50807740400	416312
50725011080	169942	50780809580	339086	50805080980	324228	50807764600	363357
50725012080	169959	50800021200	334005	50805101180	324235	50807892000	384956
50725013080	169966	50800060780	170597	50805101380	340570	50810000680	331776
50725014080	169973	50800080980	170603	50805121380	324242	50810003080	331769
50725015080	169980	50800081080	325805	50805141580	324259	50810004080	331745
50725016080	169997	50800101180	170610	50805161780	324266	50810004180	331738
50725017080	170009	50800101380	173697	50805171980	340587	50810005080	331752
50725018080	170016	50800111380	314014	50805181980	324273	50810006080	170917
50725019080	170023	50800121380	170627	50805192280	386554	50810007080	170900

Code	EAN 4024089 +	Code	EAN 4024089 +	Code	EAN 4024089 +	Code	EAN 4024089 +
50810008080	170894	50810063880	331691	50812082088	370522	50813448280	386936
50810009080	170887	50810064180	331707	50812092042	345230	50813470080	347593
50810010080	170870	50810064680	331714	50812092088	370492	50813471080	347395
50810011080	170863	50810065080	331721	50812121842	345254	50813471580	347401
50810011380	408072	50810065580	406627	50812121888	370508	50813472080	347418
50810012080	170856	50810066080	406634	50812131642	345247	50813472580	347425
50810013080	170849	50810131080	329254	50812131688	370485	50813472780	347432
50810014080	170832	50810140180	394214	50812201688	370515	50813473080	347449
50810015080	170825	50810520000	405279	50812211900	370775	50813474080	347456
50810016080	170818	50810525000	409031	50812412213	332179	50813474580	347463
50810017080	170801	50810525000	409031	50812412513	388190	50813475080	347470
50810018080	170795	50810529200	409024	50812422013	385960	50813486280	347050
50810019080	170788	50810540000	457650	50812453100	452983	50813488280	347043
50810020080	170771	50810541400	461121	50812501750	448436	50813498280	386943
50810021080	170764	50810542600	459883	50812590000	376470	50814240050	306682
50810022080	170757	50810549100	461114	50812590100	380347	50814260000	368833
50810024080	170740	50810627380	345896	50812591200	379211	50814280000	394245
50810027080	170733	50810724280	325188	50812650000	393316	50814400000	356762
50810030080	170726	50810727180	307986	50812670000	393323	50814800080	452198
50810032080	170719	50810727280	307962	50812802550	356144	50814900000	369076
50810036080	370676	50810729480	339574	50813301020	358995	50814910400	368840
50810041080	371291	50810824280	174175	50813301520	359008	50814910500	368857
50810061980	331578	50810827180	174151	50813311020	386127	50814910600	368864
50810062180	331585	50810924280	171143	50813311520	386011	50814910800	368871
50810062280	331592	50810927180	171150	50813380080	347586	50814911000	368888
50810062380	331608	50810927280	311105	50813380280	347319	50814912000	368949
50810062480	331615	50810929080	171167	50813380380	347333	50814913000	368956
50810062680	331622	50810929480	171174	50813380480	347340	50814920400	368895
50810062780	331639	50811320120	459579	50813380580	347357	50814920500	368901
50810062980	331646	50811322600	461886	50813380680	347364	50814920600	368918
50810063080	331653	50811322700	461893	50813380880	347371	50814920800	368925
50810063280	331660	50811330120	459586	50813381080	347388	50814921000	368932
50810063480	406610	50812001842	345261	50813382580	347326	50814922000	368963
50810063580	331677	50812001888	370539	50813406280	347067	50815003880	334357
50810063680	331684	50812082042	345223	50813438280	347074	50815005080	364972

Nummernliste, Numerical list, Nummerlijst, Liste des references, Lista de referencias

Code	EAN 4024089 +	Code	EAN 4024089 +	Code	EAN 4024089 +	Code	EAN 4024089 +
50815013800	334364	50816403200	359626	50817341000	459500	50825080083	329919
50815015000	364989	50816404200	359640	50817560100	380231	50825101680	382303
50815160021	353747	50816430100	353419	50817900120	428148	50825101783	392203
50815160120	365139	50816430100	353419	50817910000	373387	50825111583	365887
50815180000	442939	50816430200	359848	50817910100	373394	50825121083	323948
50815181021	331547	50816430200	359848	50817910200	386912	50825150183	394160
50815182021	442946	50816430300	361872	50817910300	390629	50825190683	329926
50815230021	326208	50816431500	361643	50817912200	387292	50825190783	329933
50815250021	326215	50816432200	359633	50817912300	390636	50825190883	329940
50815280021	326222	50816464200	380071	50817919000	374674	50825190983	329957
50815302700	371239	50816470000	380064	50817919100	377804	50825191083	329964
50815303500	371208	50816473500	380057	50818350000	360592	50825191183	329971
50815312700	371277	50816480000	380422	50818350100	402353	50825191283	329988
50815313500	371284	50816480200	380439	50818360000	406658	50825191383	329995
50815322700	371253	50816680000	370553	50818360300	448443	50825191483	331028
50815323500	371260	50816680000	370553	50818393000	386356	50825200483	345933
50815770600	462449	50816690000	362633	50818393200	386417	50825200583	345940
50815770900	434583	50816691200	362640	50820064600	416213	50825200683	345957
50815771200	434590	50816700800	386929	50820077100	416206	50825200783	345964
50816100000	361933	50816752000	359961	50820077200	416190	50825200883	345971
50816101000	361919	50816762000	359978	50820160900	404876	50825201083	345988
50816102000	361926	50816772000	359985	50820176200	416183	50825201183	345995
50816110100	404340	50816782000	359992	50822500780	356786	50825300383	330007
50816120000	361940	50816792000	360004	50825006583	395495	50825300483	330014
50816121000	361896	50816800500	360011	50825015083	329872	50825300583	331035
50816122000	361902	50816852000	435788	50825017083	364088	50825301583	328646
50816130000	423327	50817200000	356847	50825018083	369045	50825310183	330021
50816131000	423334	50817210300	448412	50825018083	369045	50825310283	330038
50816132000	423341	50817300000	356830	50825030083	331011	50825310383	330045
50816133000	423358	50817310000	380248	50825040083	329889	50825310483	330052
50816140000	443103	50817320000	385847	50825050083	329896	50825310583	450736
50816152400	449617	50817330800	386875	50825055083	350104	50825320183	331042
50816154200	449624	50817330900	386882	50825056083	369052	50825320283	331059
50816210132	356410	50817340800	459487	50825057083	369069	50825320383	331066
50816402500	359664	50817340900	459494	50825060083	329902	50825330183	331103

Code	EAN 4024089 +	Code	EAN 4024089 +	Code	EAN 4024089 +	Code	EAN 4024089 +
50825330283	331097	50829000380	332117	50830000000	356854	50840060083	330281
50825330383	331110	50829000480	332100	50831603034	452181	50840101783	392210
50825350183	330069	50829000500	332124	50831617534	452150	50840121383	323955
50825350283	330076	50829000880	332162	50831624034	452167	50840140083	330298
50825350383	331127	50829000980	332155	50831630034	452174	50840140183	394177
50825370883	331141	50829001033	332292	50833010080	379235	50840150083	330328
50825371083	331134	50829001100	332094	50833010080	379235	50840150083	330328
50825371583	330083	50829001283	332193	50833046500	387315	50840150183	394184
50825372083	330090	50829001383	332209	50833200000	327465	50840190183	330335
50825372583	330106	50829001483	332285	50833201000	390711	50840190383	330953
50825372783	330113	50829001542	348163	50833300000	381528	50840301583	328653
50825373083	330120	50829001680	350241	50833300100	381535	50840600883	330359
50825374083	331158	50829001783	350654	50833400000	387407	50840600983	330366
50825501583	328639	50829001800	381283	50833401200	390704	50840601083	330373
50825506583	395518	50829001800	381283	50833500000	404357	50840601183	330380
50825600483	330137	50829001986	386431	50833501000	404364	50840601283	330397
50825600583	330144	50829003083	346602	50834000000	368970	50840601383	330403
50825600683	330151	50829003100	346572	50834000100	368987	50840601483	330410
50825600783	330168	50829003200	346589	50834300700	369014	50840601583	330427
50825600883	330175	50829003380	346619	50834310800	369021	50840601683	330434
50825600983	330182	50829003480	346596	50834320400	369007	50840601783	330458
50825601083	330199	50829003580	346626	50834350200	369038	50840601883	330472
50825601183	330205	50829005000	394757	50834370900	368994	50840601983	330489
50825601283	330212	50829005100	394801	50835000000	402377	50840602083	331196
50825601383	330229	50829005200	394795	50839000100	202571	50840602183	330496
50825601483	330236	50829005300	394825	50839000680	176940	50840602283	330502
50825601583	331165	50829005400	394771	50839000880	176933	50840602483	331202
50825604583	330243	50829005500	394764	50839001080	177206	50842301583	388206
50825605583	330250	50829005600	394788	50839001088	371680	50845110133	375633
50825710083	435030	50829005700	394863	50839001280	313512	50845110180	326468
50825711983	435047	50829301683	381009	50839900480	365870	50845110233	375626
50825713783	435054	50829301783	353099	50840015083	330267	50845110280	326475
50825719983	435061	50829301883	365658	50840030083	332360	50845110333	375619
50828301583	369649	50829301983	389975	50840040083	330274	50845120133	332261
50829000280	332131	50829302083	423211	50840041083	331189	50845120180	409406
						50845120233	332278

Nummernliste, Numerical list, Nummerlijst, Liste des references, Lista de referencias

Code	EAN 4024089 +	Code	EAN 4024089 +	Code	EAN 4024089 +	Code	EAN 4024089 +
50845120280	409413	50850055583	394030	50850310583	339840	50850331683	349863
50845120333	375640	50850060083	330557	50850310683	339857	50850332183	349733
50845151080	409260	50850101680	382310	50850310783	349290	50850332283	349740
50845151580	409277	50850101783	392227	50850310883	349306	50850332383	349757
50845152080	409284	50850121983	323962	50850310983	349313	50850332483	349764
50845152580	409291	50850140183	394191	50850311083	350159	50850332583	349771
50845152780	409307	50850141083	331219	50850311183	339987	50850332683	349788
50845153080	409314	50850141083	331219	50850311283	339970	50850332783	349795
50845154080	409321	50850150183	394207	50850311383	350128	50850340183	349528
50845300480	326437	50850160183	442137	50850311483	339956	50850340283	349535
50845305580	326444	50850190183	330564	50850311583	339963	50850340383	349542
50845306580	326451	50850190383	330571	50850311683	350135	50850340483	349559
50845361033	332230	50850190483	433913	50850311783	350142	50850340583	349566
50845361233	332247	50850191083	330588	50850311883	339994	50850340683	349573
50845367533	332223	50850191383	330595	50850311983	350166	50850340783	349580
50845500033	387995	50850191483	330601	50850312283	350173	50850342183	349597
50845600080	409338	50850191583	330618	50850312483	350180	50850342283	349603
50845640080	387988	50850191783	330625	50850312583	350197	50850342383	349610
50846000033	369113	50850191983	330632	50850312683	350203	50850342483	349627
50847000033	373677	50850192283	331226	50850312783	350210	50850342583	349634
50848002600	381252	50850192483	331233	50850312883	434705	50850342683	349641
50848002700	381238	50850201083	346008	50850312983	434729	50850342783	349658
50848010000	380088	50850201183	346015	50850313083	434712	50850360383	349825
50848010400	461138	50850201283	346022	50850313183	435016	50850360483	349832
50849000900	449648	50850201483	346039	50850313283	435023	50850360683	349849
50849001400	377842	50850201683	346046	50850330183	349665	50850360883	349856
50849401680	410419	50850201883	346053	50850330283	349672	50850361083	349429
50850006583	395501	50850202083	346060	50850330383	349689	50850361183	349436
50850015083	330519	50850202283	346077	50850330483	349696	50850361283	349443
50850030083	332377	50850202483	346084	50850330583	349702	50850361383	349450
50850040083	330526	50850310083	349276	50850330683	349719	50850361483	349467
50850045083	350081	50850310183	349283	50850330783	349726	50850361583	349474
50850050083	330540	50850310283	339819	50850331283	349894	50850361683	349481
50850055083	350098	50850310383	339826	50850331483	349900	50850361783	349498
50850055483	394023	50850310483	339833	50850331583	349917	50850361883	349504

Code	EAN 4024089 +	Code	EAN 4024089 +	Code	EAN 4024089 +	Code	EAN 4024089 +
50850361983	349511	50850601683	330823	50863000300	331790	50895100080	371413
50850362083	349320	50850601783	330717	50863001436	459845	50895311380	371321
50850362583	349337	50850601883	330724	50863001760	332001	50895311480	371338
50850362783	349344	50850601983	330731	50863001960	332018	50895311780	371345
50850363083	349351	50850602083	330748	50863002160	332025	50895311880	371352
50850364083	349368	50850602183	330755	50863190300	331806	50895312280	371376
50850364583	349375	50850602283	330762	50863191436	459838	50895312480	371383
50850365083	349382	50850602383	331301	50863191760	332032	50895312780	371390
50850365583	349399	50850602483	330779	50863191960	332049	50895313080	371406
50850366083	349405	50850602783	330786	50863192160	332056	50895632036	451252
50850367083	349412	50850603083	330793	50863311036	459821	50895635036	451269
50850372083	340020	50850603283	330816	50863361036	459814	50896101360	443035
50850372583	340037	50850603483	433890	50865001036	459852	50896111260	443042
50850372783	340044	50850603683	433906	50865191036	459869	50897000400	461862
50850373083	331240	50850631983	382143	50867500000	395228	50897000500	461862
50850374083	331257	50850632183	382150	50867500100	450187	50898101260	339550
50850374583	331264	50850632383	382167	50867626000	453119	50899000560	441918
50850375083	331271	50850632583	382174	50872301583	348590	50958171980	144185
50850375583	349801	50850632783	382181	50879000080	364811	58103000100	164336
50850376083	349818	50850632983	382198	50880000020	395488	88104001200	370348
50850530083	346367	50850633183	382204	50880000080	348156	90050160083	074857
50850540083	346374	50850633383	382211	50880700100	364774	90050160083	074857
50850550083	346381	50850633483	382228	50880700200	364781	90050400080	142389
50850551283	346398	50850633583	382235	50880700300	364798	90833120305	331530
50850560283	346428	50850633783	382242	50880700400	364804	90880701500	331486
50850580083	405798	50850633883	382259	50881000600	390490	90950103220	144192
50850590083	346411	50850633983	382266	50882000080	307337	90955020020	144215
50850600883	331288	50850634083	382273	50883301683	381030	91132800120	459777
50850600983	331295	50850634183	382280	50885000080	176957	91132800220	459784
50850601083	330649	50850790083	388558	50886000080	371307	91132800320	459791
50850601183	330656	50851301583	328677	50888021080	444728	91132800420	459807
50850601283	330670	50852201683	381016	50888035080	444735	98076080020	089257
50850601383	330687	50853301583	328660	50889694400	448405	98263060080	090949
50850601483	330694	50854301683	381023	50890300200	339567	98718500000	387841
50850601583	330700	50860301580	318913	50890300300	381269		

Inhaltsverzeichnis

Artikel	
A	
Abzieher	167
Adapter 1/2"	35
Adapter 1/4"	21/24
Adapter 3/4"	49
Adapter 3/8"	29-30
Arbeitshandschuhe	169
Arbeitslampe	168
Architekten-Bauschlüssel	109
Automatische Abisolierzange	152
B	
Bandmaß	162
Bauhandsäge	118
Bit Adapter	21/24
Bit-Box-Sätze	111-112
C	
Crimpzange	151
Cuttermesser	115
D	
Dämmstoffmesser	118
Doppelmaulschlüssel	7
Doppelringschlüssel	10
Drahtsäge Set	133
Drehmomentschlüssel	85-86
Dreikant-Rohrsteckschlüssel	109
Dreikant-Steckschlüssel	108
Drillapparat	160
Durchsteckknarre	32/48/135
E	
Eckrohrzangen	89
Einmaulschlüssel	9
Einsatzspender	172-173
Einsteckknarre	87
Einsteckmaulschlüssel	87
Elektriker Koffer	142
Elektriker Rucksack	141
Elektrikertasche	143
Express-Schlüssel	134
F	
Feinmechaniker- Sätze	102
Flachrundzange	91
Fugenabzieher	129
G	
Gerüstbauer-Werkzeugsatz	160
Gerüstbauknarre	159-160
Gerüstbauschlüssel	161
Gewindeschneidsatz	167
Gleitstück	29/35
Griff mit Gleitstück 1/2"	34

Artikel	
Griff mit Gleitstück 1/4"	18
Griff mit Gleitstück 3/4"	48
Griff mit Gleitstück 3/8"	29
Gripzange	95
H	
Hämmer	97-99
Hammer Ersatzköpfe	99
Handfeile	115
Handhebelbrett	130
Handsäge	116-117
Hebel- und Montageeisen	162
Hebelblechschere	95
Hebelumschaltknarre 1/2"	33
Hebelumschaltknarre 1/4"	16-17
Hebelumschaltknarre 3/8"	28
I	
IMPACT-Schraubendrehereinsatz	51
IMPACT-Steckschlüssel	155
IMPACT-Steckschlüsseleinsätze	52/53
J	
Japansäge	116
K	
Kabel-Klappmesser	114/152
Kantenzange	93
Kapsel-Gehörschutz	168
Kardangelenk 1/2"	35/136
Kardangelenk 1/4"	19
Kardangelenk 3/8"	29
Kartuschenpistole	128-130
Knarren-Ringmaulschlüssel	11-13
Knarren-Ringschlüssel	14
Knarrenrohrabschneider	132
Kneif-/Rabitzzange	92
Kombinationszange	91
Kraftseitenschneider	92
Kugelpopf-Winkelschraubendrehersatz	106
Kupferrohrbürste	134
L	
L-Boxx	71
M	
Magnet Bithalter	21/104
Maßstab	164
Metallbügelsäge	119
Mini-Bit-Knarre	18
Montage Werkzeugkasten	68-70
Montage Werkzeugkoffer	72-73
Montage Werkzeugsortiment im Rucksack	75-78
Montage Werkzeugsortiment in Umhängetasche	80
Montagezangen-Satz	93

Inhaltsverzeichnis

Artikel	
Montiereisen	156
Multifunktionszange	94
O	
Ölbrennerschlüssel	137
Ölfilter-Bandschlüssel	157
Ölfilterspinne	156
R	
Radwechsel-Werkzeugsatz	154
Ringmaulschlüssel	8
Rohrabschneider	131/133
Rohrentgrater	132
Rohrsteckschlüssel	137
Rucksack	74/77-78
S	
Sägeblätter	117
Sanitär Werkzeugkasten	123
Sanitär-Garnitur	136
Sanitärkreuzschlüssel	138
Sanitär-Werkzeugsätze	121-122
Sanitär-Werkzeugsortiment für L-Boxx®	125-127
Saugheber	131
Schere	93
Schlauchschnidezange	95
Schraubendreher	103/105
Schraubendreher-Einsätze	20/23/38-39
Schraubendrehereinsatz-Sortimente 1/2"	45-47
Schraublocher	139
Schutzbrille	169
Seitenschneider	92
Sicherheitsleine	161
Spannungsprüfer	148/150
Spannungstester	150
Splinttreibersatz	100
Stablampe	168
Standhahnmutternschlüssel	138
Steckgriff	19
Steckschlüssel	104
Steckschlüssel- und Bitsgarnitur 1/4"	26-27
Steckschlüssel- und Ringmaulschlüsselgarnitur 1/2"	47
Steckschlüsseleinsätze 1/2"	37
Steckschlüsseleinsätze 1/4"	19-20/22-23
Steckschlüsseleinsätze 3/4"	49
Steckschlüsseleinsätze 3/8"	30
Steckschlüsselgarnitur 1/2"	40-44
Steckschlüsselgarnitur 1/4"	25-26
Steckschlüsselgarnitur 3/4"	50
Steckschlüsselgarnitur 3/8"	31
Steckschlüsselsatz	104
Stirnleuchte	163
Stufenschlüssel	135-136

Artikel	
T	
Taschen	81-83
Teleskop-Rohrabschneider	132
T-Griff mit Ratschenfunktion	17
T-Griff Steckschlüssel-Garnitur	25
TORX®-Schraubendreher	103/106-108
U	
Umhängetaschen	79
Umschaltknarre 3/4"	48
V	
VDE Abisolierzange	147
VDE Einmaulschlüssel	152
VDE Flachrundzange	146
VDE Kombinationszange	146
VDE Kraftseitenschneider	147
VDE Schraubendreher	148
VDE Seitenschneider	147
VDE-Elektrikersatz	144-145
VDE-Werkzeugsatz	149
VDE-Werkzeugsortiment	145
Verbindungsvierkant	32/135
Verlängerungen 1/2"	34
Verlängerungen 1/4"	18
Verlängerungen 3/4"	49
Verlängerungen 3/8"	29
W	
Wasserpumpenzange	89-90
Wasserwaage	163
Werkstattfeilen	114
Werkstattwagen	55-57
Werkstattwagen Module	59-66
Werkstattwagen Zubehör	58-59
Werkzeugkasten „JUNIOR“	70
Werkzeugrolltasche	81
Werkzeugsatz mit Meißel, Körner, Splint- und Durchtreiber	100
Winkelschraubendrehersatz	105
Z	
Zimmermannswinkel	164
Zündkerzeneinsätze	31/37

Index

Article	
A	
Adapter 1/2"	35
Adapter 1/4"	21/24
Adapter 3/4"	49
Adapter 3/8"	29-30
Adjustable wrenches	9
Architects' Construction Key	109
Automatic wire stripping plier	152
Automatic Wire Twister	160
B	
Backpacks	74/77-78
Bags	81-83
Basin wrench	138
Bit adapter	21/24
Bit-box-sets	111-112
C	
Cable folding knife	114/152
Carpenter's square	164
Caulking gun	128-130
Chisel and pin punch set	100
Circlip plier set	93
Combination plier	91
Combination ratchet wrenches	11-13
Combination ratchet wrenches	14
Combination stepped key	135-136
Combination wrenches	8
Construction hand saw	118
Construction tool case	72-73
Copper tube pouch	134
Crimping tool	151
D	
Diagonal cutting nipper	92
Diagonal cutting nipper	92
Die cutting set	167
Double ended open jaw wrenches	7
Double ended ring wrench	161
Double ended ring wrenches	10
Double ended tubular socket wrenches	137
E	
Elbow pipe wrenches	89
Electrician's backpack	141
Electrician's bag	143
Electrician's toolcase	142
End cutting plier	93
Engineers' files	114
Extensions 1/2"	34
Extensions 1/4"	18
Extensions 3/4"	49
Extensions 3/8"	29

Article	
F	
Foldable ear muff	168
G	
Grip pliers	95
H	
Hacksaw	119
Hammer spare heads	99
Hammers	97-99
Hand file	115
Handsaw	116-117
Handy screeding pads set	129
Headlamp	163
Hose cutting pliers	95
I	
IMPACT screw driver socket set	51
IMPACT socket sets	52/53
IMPACT sockets	155
Installation tool set in backpack	75-78
J	
Japanese Saw	116
K	
Knife for insulating material	118
L	
L-Boxx	71
LED Torchlight	168
Lever plate shear	95
Lever type reversible ratchet 3/4"	48
M	
Magnetic bitholder	21/104
Measuring tape	162
Mini-bit ratchet	18
Multifunction plier	94
N	
Nut spinner	104
Nut spinner set	104
O	
Oil burner key	137
Oil filter strap wrench	157
Oil filter wrench	156
Open ended jaw wrench insert tools	87
P	
Pin punches set	100
Precision sets	102
Profi caulking gun	130
Protective glasses	169
Protective gloves	169
Pry bar	162
Pullers	167

Index

Article	
R	
Ratchet	32/48/135
Ratchet tube cutter	132
Ratchets 1/2"	33
Ratchets 1/4"	16-17
Ratchets 3/8"	28
Reversible ratchet heads	87
Rule	164
S	
Safety leash	161
Sanitary cross wrench	138
Sanitary tool box	123
Sanitary tool set	136
Sanitary tool set for L-Boxx	125-127
Sanitary tool sets	121-122
Sanitary wrench	134
Saw blades	117
Scaffold ratcheting wrench	159-160
Scaffolding tool set	160
Scissors	93
Screw Hole Punch	139
Screwdriver socket set 1/2"	45-47
Screwdriver sockets	20/23/38-39
Screwdrivers	103/105
Set of ball head hexagonal wrenches	106
Set of hexagonal head wrenches	105
Shoulder bags for tools	79
Sliding T-handle 1/2"	34
Sliding T-handle 1/4"	18
Sliding T-handle 3/4"	48
Sliding T-handle 3/8"	29
Sliding T-head	29/35
Snipe nose plier	91
Socket- and bit-set 1/4"	26-27
Socket dispenser	172-173
Socket sets 1/2"	40-44
Socket sets 1/4"	25-26
Socket sets 3/4"	50
Socket sets 3/8"	31
Sockets 1/2"	37
Sockets 1/4"	19-20/22-23
Sockets 3/4"	49
Sockets 3/8"	30
sockets and combination wrenches set	47
Spark plug sockets	31/37
Spinner handle	19
Spirit Level	163
Square coupler	32/135

Article	
T	
Telescopic tube cutter	132
T-Handle socket set	25
T-handle with ratchet	17
Tool assortment in shoulder bag	80
Tool box „JUNIOR“	70
Tool box, cantilever type	68-70
Tool wallet	81
Torque wrenches	85-86
TORX®-Screwdrivers	103/106-108
Tower pincers	92
Tube cutter	131/133
Tube trimming tool	132
Tubular triangular wrench	109
Tubular triangular wrench	108
Tyre lever	156
U	
Universal joint 1/2"	35/136
Universal joint 1/4"	19
Universal joint 3/8"	29
Utility knife	115
V	
Vacuum lifting pad	131
VDE Adjustable wrench	152
VDE Combination plier	146
VDE Diagonal cutting nipper	147
VDE Diagonal cutting nipper	147
VDE Electricians-set	144-145
VDE Screwdriver	148
VDE Snipe nose plier	146
VDE Tool set	149
VDE Tool set	145
VDE Wire stripping pliers	147
Voltage tester	148/150
Voltage tester	150
W	
Water pump pliers	89-90
Wheel changing tool set	154
Wire saw set	133
Working lamp	168
Workshop trolley	55-57
Workshop trolley accessories	58-59
Workshop trolley modules	59-66

Verkaufs-, Lieferungs- und Zahlungsbedingungen

1. Anerkennung der Verkaufs-, Lieferungs- und Zahlungsbedingungen

Unsere Verkäufe basieren auf den nachstehenden Bedingungen, wobei jeweils nur die neuesten Verkaufsunterlagen Gültigkeit besitzen. Abweichungen oder mündlich getroffene Nebenabsprachen bedürfen unserer schriftlichen Bestätigung. Bedingungen der Besteller können wir nicht anerkennen, auch dann nicht, wenn von uns nicht ausdrücklich widersprochen wird. Der Besteller erkennt durch die Erteilung seines Auftrages unsere Bedingungen an. Vertragsgültigkeit wird erst durch unsere schriftliche Auftragsbestätigung erreicht.

2. Angebote

Unsere Angebote sind freibleibend, Katalog und Preisliste sind Bestandteile unseres Angebotes. Maß- und Gewichtsangaben sowie Abbildungen, Leistungsbeschreibungen, technische Zeichnungen und Daten sind unverbindlich, sofern sie nicht ausdrücklich als verbindlich bestätigt werden, sie können jederzeit und ohne besondere Anzeige geändert werden.

3. Schutzrechte

Werkseigene Zeichnungen, Abbildungen, Photos und sonstige Unterlagen bleiben auch nach Weitergabe an den Besteller oder an Dritte unser Eigentum und unterliegen dem Urheberrecht. Ohne unsere Erlaubnis dürfen diese weder vervielfältigt noch anderen zugänglich gemacht werden. Sie sind an einem sicheren Ort aufzubewahren und auf Verlangen an uns zurückzugeben. Werden bei der Anfertigung von Waren nach Zeichnungen, Mustern bzw. sonstigen Angaben des Bestellers Schutzrechte Dritter verletzt, so stellt dieser uns von sämtlichen Ansprüchen frei.

4. Sonderanfertigungen

Bei Sonderanfertigungen behalten wir uns das Recht einer Mehr- bzw. Minderlieferung bis zu 10 % vor. Hierzu zählen ebenfalls Serienteile, die auf ausdrücklichen Wunsch des Bestellers besonders zu zeichnen sind. Der Besteller kann nicht vom Auftrag zurücktreten; besonders hergestellte oder gezeichnete Ware wird von uns nicht zurückgenommen.

Im Falle von Zahlungsunfähigkeit bzw. Konkurs des Bestellers behalten wir uns das Recht vor, die Ware direkt zu verkaufen. Bei Herstellung nach Unterlagen des Bestellers haftet dieser für die Richtigkeit seiner Zeichnungen, Muster, Lehren usw. Muster werden grundsätzlich nur gegen Berechnung geliefert.

5. Preise

Unsere Preise sind freibleibend in EUR und als unverbindliche Preisempfehlung anzusehen. Sie verstehen sich ausschließlich Mehrwertsteuer, wobei der am Tage der Lieferung gültige Mehrwertsteuersatz Anwendung findet.

Eine Berichtigung unserer Preise behalten wir uns vor, sofern bis zum Tage der Lieferung Änderungen in den Grundkosten, wie Rohmaterial, Energie, Löhne usw. eintreten. Lieferungen erfolgen grundsätzlich in den im Katalog genannten Verpackungseinheiten. Kleinere oder durch die Verpackungseinheiten nicht teilbare Mengen werden lose in Papier verpackt und mit einem Aufschlag von 25 % belastet, sofern in unseren Verkaufsunterlagen kein anderweitiger Vermerk gemacht wird.

6. Zahlungsbedingungen

Unsere Rechnungen sind zahlbar Inland: 10 Tage nach Rechnungsdatum abzüglich 2 % Skonto oder 30 Tage nach Rechnungsdatum netto, falls keine anderen Vereinbarungen getroffen wurden.

Ausland: Nach besonderen Vereinbarungen; maßgebend ist der Zahlungsvermerk auf dem jeweiligen Angebot, der Proforma-Rechnung bzw. der Rechnung. Beträge unter EUR 25,- netto sind grundsätzlich nicht skontoberechtigt. Wechsel werden nur nach vorheriger Vereinbarung hereingenommen. Die Kosten der Diskontierung und Einziehung trägt grundsätzlich der Besteller. Bei Zahlungsverzug oder Stundung belasten wir Zinsen in Höhe von 2 % über dem zu diesem Zeitpunkt gültigen Diskontsatz der Deutschen Bundesbank. Die Wertstellung eingegangener Schecks und Wechsel erfolgt zu dem Tag, an dem wir über den Gegenwert verfügen können. Sollten uns nach Vertragsabschluß Umstände bekannt werden, welche die Kreditwürdigkeit des Kunden beeinträchtigen, sind wir berechtigt, Vorauszahlung oder andere Sicherheitsleistungen zu verlangen. Eine Zurückhaltung der Zahlung wegen Minderungs-, Wandlungs-, oder eventueller anderer Gegenansprüche, sowie die Aufrechnung mit solchen ist nicht zulässig.

7. Lieferung und Versand

Wenn nicht anders vereinbart, liefern wir grundsätzlich ab Werk ausschließlich Verpackung und Versand der Ware auf Gefahr des Bestellers erfolgen. Versicherungen gegen Diebstahl, Transportschäden usw. erfolgen nur auf Wunsch und Kosten des Bestellers. Falls keine besondere Vorschrift gegeben wird, wählen wir den günstigsten Versandweg.

Waren, die zu einem vereinbarten Termin versandbereit gemeldet werden, müssen umgehend abgerufen werden, da wir andernfalls berechtigt sind, diese auf Kosten und Gefahr des Bestellers zu lagern und als geliefert zu berechnen. Für Verladungen setzen wir Netto - Mindestauftragswerte wie folgt voraus: Inland - EUR 100,- Ausland - EUR 500,-, sofern in unseren Verkaufsunterlagen kein anderweitiger Vermerk gemacht wird. Wir behalten uns vor, Aufträge unter dieser Grenze entweder bis zum Erreichen des Mindestauftragswertes zurückzustellen oder mit einer Bearbeitungsgebühr von EUR 10,- zu belasten.

8. Eigentumsvorbehalt

Die gelieferte Ware bleibt bis zur endgültigen Bezahlung ohne Rücksicht auf den Rechtsgrund unser Eigentum. Für den Fall der Bezahlung auf Scheck-Wechselbasis bleibt der Eigentumsvorbehalt bis zur Einlösung des Wechsels durch den Besteller bestehen.

Der Besteller ist, so lange er sich nicht in Verzug oder in Zahlungsschwierigkeiten befindet, zur Veräußerung der Ware im ordnungsgemäßen Geschäftsverkehr berechtigt. Veräußert der Besteller die in unserem Vorbehaltseigentum stehende Ware, werden die durch die Veräußerung entstehenden Forderungen schon jetzt an uns abgetreten, ohne daß es im Falle der Veräußerung einer ausdrücklichen Bestätigung bedarf. Er ist nicht berechtigt, die Vorbehaltswaren zu verpfänden oder zur Sicherheit an Dritte zu übereignen.

Bis zur endgültigen und vollständigen Bezahlung der Ware steht uns das Recht zu, auch ohne Ausübung des Rücktritts und ohne Nachfristsetzung auf Kosten des Bestellers die einstweilige Herausgabe der Vorbehaltsware zu verlangen, die Räumlichkeiten des Bestellers zu betreten und die Ware nötigenfalls wieder an uns zu nehmen.

Wird eine Be- oder Verarbeitung bzw. untrennbare Vermischung der Vorbehaltsware mit anderen, nicht dem Lieferer gehörenden Gegenständen vorgenommen, so erwerben wir das Miteigentum an der neuen Sache im Verhältnis des Rechnungswertes der Vorbehaltsware zu den anderen verarbeiteten oder vermischten Gegenständen zum Zeitpunkt der Verarbeitung oder Vermischung. Wird die gelieferte Ware vom Besteller oder dessen Beauftragten verändert oder als Teil größerer Einheiten verwendet, so geht unser Eigentum anteilmäßig automatisch auf die veränderte Ware oder die entstandenen größeren Einheiten über. Der Besteller verwahrt das Eigentum oder Miteigentum für den Lieferer und ist verpflichtet, diese gegen Feuer, Diebstahl und Wasser zu versichern. Etwaige Entschädigungsansprüche, die aus Schäden vorgenannter Art gegen Versicherungsgesellschaften oder sonstige Ersatzverpflichtete zustehen, werden in Höhe unserer Forderungen an uns abgetreten. Pfändungen oder andere Beeinträchtigungen unseres Eigentums sind uns unverzüglich mitzuteilen.

Ohne die bisher dargelegten Bedingungen einzuschränken, geht das Risiko für die gelieferte Ware vom Tage der Lieferung auf den Besteller über.

9. Lieferzeit, Liefermöglichkeit

Lieferfristenangaben sind annähernd und ohne Verbindlichkeit für uns. Verzugsespesen und Schadenersatzansprüche bei Lieferverzögerungen können gegen uns in keinem Falle geltend gemacht werden. Die Lieferzeit beginnt nach Klärung sämtlicher kaufmännischer und technischer Einzelheiten. Wir sind berechtigt, Teillieferungen durchzuführen.

10. Höhere Gewalt

Streik und Aussperrung, Katastrophen, Betriebsstörungen, Materialmängel, Verkehrsmängel oder andere Ereignisse höherer Gewalt, ganz gleich ob sie bei uns oder bei unseren Vorlieferanten eintreten, entbinden uns von allen Verpflichtungen.

11. Mängelrügen

Beanstandungen werden nur entgegengenommen, wenn sie schriftlich und umgehend, d. h. sofort nach Erhalt der Sendung, angezeigt werden. Ein Recht auf Wandlung oder Minderung steht dem Besteller nicht zu. Über den Warenwert hinausgehende Ansprüche können nicht gestellt werden. Transportschäden sind stets beim Frachtführer zu reklamieren.

12. Garantie, Gewährleistung

Alle HEYTEC-Werkzeuge werden in unseren Werken sorgfältig überprüft und unterliegen voll der Garantie.

Wir ersetzen jedes Werkzeug kostenlos, das Material- oder Fertigungsfehler aufweist. Eine weitere Haftung ist ausgeschlossen. Kostenloser Ersatz erfolgt nicht, wenn die Untersuchung in unserem Werk ergibt, daß das Werkzeug unsachgemäß behandelt worden ist oder ein natürlicher Verschleiß vorliegt.

13. Haftung

Schadenersatzansprüche aus Fehlen zugesicherter Eigenschaften, Verzug, Unmöglichkeit der Leistung, schuldhafter Verletzung vertraglicher Nebenpflichten, sowie aus Verschulden bei Vertragsabschluß und aus unerlaubter Handlung werden ausgeschlossen, es sei denn, sie beruhen auf Vorsatz oder grober Fahrlässigkeit unserer gesetzlichen oder sonstigen uns zuzurechnenden Vertreter.

14. Erfüllungsort und Gerichtsstand

Erfüllungsort der Lieferung und Zahlung ist Remscheid. Gerichtsstand ist Remscheid. Es gilt das Recht der Bundesrepublik Deutschland.

15. Export und Re-Export

HEYTEC-Ware darf nur mit unserer schriftlichen Genehmigung exportiert oder re-exportiert werden.

Terms of sale, delivery and payment

1. Acceptance of terms of sale, delivery and payment

Our sales are based on the following terms and conditions whereby only the latest issue of our sales literature is valid.

Any variations to these and verbal arrangements require our confirmation in writing. Conditions of the buyer shall not be binding to us, also if not expressly objected by us. The placing of an order contract with us implies acceptance of our conditions. Validity of contract is only reached with our written order confirmation.

2. Quotations

Our offers are without obligation. Catalogue and pricelist form part of our offers. Weights and dimensions, illustrations, performance details, technical drawings and data are subject to change without prior notice, unless contracted and confirmed otherwise.

3. Copyright

All drawings, illustrations, photographs and other documents supplied by us to customers or third parties remain our property and are subject to copyright. They are not to be reproduced or made available to others without our written consent; they are to be stored in a safe place and must be returned to us on demand. Should production of merchandise to drawings, samples or other customer's specification involve an infringement of third party copyrights the customer indemnifies us from and against all claims.

4. Special manufacture

We reserve the right to modify the quantities ordered for special production by plus or minus 10 %, also normal production items, which are marked or finished to buyer's special requirements. Such orders cannot be cancelled once accepted by us. We are unable to accept the return of such items for credit or allowance.

If the customer becomes insolvent or bankrupt we reserve the right to sell this merchandise directly. For production to customer's documents the customer shall be solely responsible for the accuracy of drawings, samples, gauges etc. On principle samples are only supplied against invoice.

5. Prices

We reserve the right to adjust prices in case there should be changes in basic production costs, such as raw material, power, wages etc. up to date of delivery. Parts ordered will only be shipped in packing units identified in our sales literature. Smaller quantities or quantities, which are not divisible by packing units will be packed in paper only and levied with an increase of 25 % provided no other information has been given in our sales literature.

6. Terms of payment

Our invoices are payable Home market: 10 days after date of invoice less 2 % cash discount or 30 days after date of invoice net, provided no other arrangements have been agreed. Export markets: According to special arrangements, which are stated on our quotations, proforma invoices, order confirmations and/or invoices.

On principle invoice values below EUR 25,- net do not qualify for cash discount. Drafts will only be accepted after prior arrangements and all charges are to buyer's account. In the event of delayed payments or respites we shall charge interests at a rate of

2 % above the bank rate of the Deutsche Bundesbank being in force at the relevant time.

The credit values of cheques and drafts received are entered for that day, when their value is at our disposal. In case we should learn about circumstances restricting the creditworthiness of the customer after a contract has been concluded, we are permitted to ask for payment in advance or other satisfactory securities.

Retention of payment due to claims of diminution, transformation or other eventual counterclaims as well as settling of accounts incorporating the above is not permissible.

7. Dispatch and delivery

Unless arranged and confirmed to the contrary delivery is effected ex works, packing excluded. Goods are delivered at buyer's risk. Insurance against theft, damages in transit etc. can be arranged on specific request and to customer's account. We reserve the right to choose the most economic method of transport unless particular instructions are given.

Goods, which have been packed to be ready for dispatch for an agreed date must be called off immediately, as otherwise we are entitled to store same at buyer's risk and cost and to invoice shipment as delivered.

For shipments our minimum net order values are - Home market EUR 100,- Export markets EUR 500,-, unless no other terms are quoted in our sales literature. Terms of Sale, Delivery and Payment. For orders with smaller values we reserve the right to postpone shipment until minimum order value is reached or to charge a handling fee amounting to EUR 10,00.

8. Title to the goods

Goods delivered remain our property until payment is received in full. It is expressly reserved that any law contradicting this clause shall not impair our rights concerning our goods. The buyer may dispose of the goods in the usual businesslike manner provided he is not insolvent or in default. Should the customer sell goods, which are still our property respective credit is due to our account automatically without express confirmation. The buyer is not entitled to distract or, as security to third parties, assign goods which are still our property.

Until paid for in full we are entitled to demand the release of goods and to enter buyer's premises with the object of re-taking possession of the goods. We are not obliged to execute withdrawal and to award postponement at customer's costs.

In case processing, further treatment or inseparable blending of provisogoods is effected with other merchandise or parts not belonging to us, we automatically gain partial ownership on the processed goods to such value as it is in relation to the processed or blended merchandise at the moment of processing or blending. Should supplied goods through buyer or on behalf of buyer be subjected to alterations or be used as part of larger units, then automatically partial ownership is transferred to the changed merchandise or the produced larger units. The buyer storing seller's property or partial property is obliged to secure same against fire, theft and water. Eventual claims for damages against insurance companies resulting from damages mentioned before are to be assigned to us representing the amount of our claim. Distraints and/or any other limitation, which might be imposed on our property despite the reservations outlined in the proceeding sentences must be reported immediately.

Notwithstanding the conditions outlined above, goods are at the entire risk of the buyer from the date of delivery.

9. Time of delivery and delays

All information given in respect of delivery period is approximate and without obligation. Liability in case of delay in delivery, interest for delay and/or damages cannot be accepted. The time of delivery begins only after clarification of all clerical and technical details. We are permitted to effect part shipments.

10. Force majeure

Force majeure, such as strike and lock-out, catastrophes of any kind, breakdown in supply of any kind, delivery of faulty material or other restrictions through force majeure shall release us from our liabilities, no matter if occurred with us or our sub-suppliers.

11. Claims

Claims must be made immediately on receipt of the goods and in writing, as otherwise such claims will not be accepted by us. Amendments to or deductions from invoices will not be accepted. The customer is not entitled to make claims above the nominal value of the goods involved. Damages in transit are to be claimed with the carrier.

12. Guarantee, warranty

All HEYTEC tools are carefully tested before leaving our works and are fully guaranteed. We shall replace free of charge any tool indicating faults of material and workmanship. Any further liability is excluded. Tools returned as faulty, which on inspection/test prove to have failed due to abuse, incorrect use or fair wear and tear are excluded from this guarantee and replacement will be charged.

13. Liability

Claims for compensation due to missing of promised features, delays, impossibility of performance, guilty violation of contractual secondary obligations, faults with conclusion of contract as well as unauthorized action are excluded save where our legal representatives are shown to have acted on purpose or negligently.

Liability even for careless violation is limited to compensation, which is foreseeable at the moment of conclusion of contract.

14. Settling place and place of competency

Remscheid is the settling place for delivery, payment and competency of justice in case of dispute. Only the law of the Federal Republic of Germany shall govern.

15. Export and re-export

Only with our written approval HEYTEC goods may be exported or re-exported.

Abkürzungen, Symbole, Hinweise

Alle Katalogartikel werden technisch ständig optimiert; daher sind Änderungen jederzeit und ohne Ankündigung möglich. Unsere Katalogpreise sind Grundpreise ohne Mehrwertsteuer.

Sie sind bei Weiterverkauf durch den Handel als unverbindliche Preisempfehlung anzusehen und nicht zur Weitergabe bestimmt. Der Nachdruck dieses Kataloges oder Teilen daraus, die Vervielfältigung, Speicherung und Übermittlung jedweder Art, auch durch Datenverarbeitungsanlagen, sind nur mit unserer schriftlichen Genehmigung gestattet.

Abbreviations, symbols, notes

All catalogue articles are continuously updated to the latest technical standards. As a result, specifications are subject to change without prior notice. Our catalogue prices are gross-prices, excluding value added tax. They are to be considered as recommended retail prices. Reprint of this catalogue or parts thereof, reproduction, storage in retrieval systems, unauthorized utilization and transmission in any form or by any means including computer systems is only permitted with our prior consent in writing.

Afkortingen, symbolen, verwijzingen

Alle artikelen in deze catalogus worden in technisch opzicht voortdurend verbeterd; daarom zijn wijzigingen te allen tijde en zonder aanzegging mogelijk.









































Nadruk van deze catalogus of delen ervan, vermenigvuldiging, opslag en overdracht van welke aard dan ook, ook door gegevensverwerkende installaties, zijn alleen toegestaan met onze schriftelijke toestemming.

























































Abréviations, symboles, indications

Les produits du catalogue étant soumis à des améliorations techniques permanentes, le fabricant se réserve le droit de modifier leurs caractéristiques à tout moment et sans préavis. Les prix indiqués dans ce catalogue sont des prix de base hors T.V.A. Ils sont donnés à titre indicatif aux revendeurs et ne sont pas destinés à être divulgués. Toute reproduction, copie ou diffusion totale ou partielle que ce soit, notamment par photocopie ou par équipement informatique, est interdite sans notre autorisation écrite.

Abreviaturas, símbolos, información

Todos los artículos del catálogo están sometidos a perfeccionamiento continuo. Por eso, están sujetos a posibles modificaciones sin previo aviso. Observen que los datos contenidos en las tablas están solamente en alemán e inglés. Para condiciones de venta, envío y pago, índice alfabético véanse catálogos en vigor. El presente catálogo – tarifa refleja precios de venta al público recomendados, por pieza/juego, I.V.A. no incluido. La reproducción íntegra o parcial de este catálogo, su copia, registro o retransmisión de cualquier tipo, incluso por medios informáticos, requieren obligatoriamente nuestra autorización escrita.



 Packeinheit	 packing unit
 Länge	 length
 Durchmesser	 diameter
 metrische Schlüsselweiten für Schrauben und Muttern mit Außensechskant	 spanner openings in metric for hexagon head screws, bolts and nuts
 metrische Schlüsselweiten für Innensechskantschrauben	 sizes in metric for hexagon socket screws and bolts
 Schlüsselweite bei TORX®-Schrauben	 size in millimetres for TORX®-screws
 Innensechskant Schon-Profil	 inside hexagon (profile saver)
 Innen-Doppelsechskant Schon-Profil	 inside bihexagon (profile saver)
 für Außen-TORX®-Schrauben	 for TORX®-head screws
 Innenvierkant	 inside square
 Außenvierkant	 outside square
 Außensechskant u. für Innensechskantschrauben	 outside hexagon – for hexagon socket screws
 für Schlitzschrauben	 for plain slot screws
 für Kreuzschlitzschrauben PHILLIPS-RECESS	 for cross slot screws PHILLIPS-RECESS
 für Kreuzschlitzschrauben POZIDRIV®	 for cross slot screws POZIDRIV®
 für Innen-Keilprofil-Schrauben RIBE CV	 for fluted socket screws RIBE CV
 für Innenvielzahn-Schrauben XZN	 for multi-spline socket screws XZN
 für Innen-TAMPER-TORX®-Schrauben	 for TAMPER-TORX®-socket screws
 für Innen-TORX®-Schrauben POZIDRIV® eingetragenes Warenzeichen der Firma European Industrial Services Ltd.	 for TORX®-socket screws POZIDRIV® Registered trade mark of European Industrial Services Ltd.
 eingetragenes Warenzeichen der Firma CAMCAR/TEXTRON INC.	 Registered trade mark of CAMCAR/TEXTRON INC.

 verpakkingseenheid	 unité d'emballage	 unidad de envase
 lengte	 longueur	 longitud
 diameter	 diamètre	 diámetro
 metrische sleutelwijdte voor bouten en moeren met buitenzeskant	 ouvertures métriques pour vis et écrous hexagonaux	 medidas métricas para tornillos y tuercas con hexágono exterior
 metrische sleutelwijdte voor binnenzeskant-bouten	 ouvertures métriques pour vis 6 pans creux	 medidas métricas para tornillos con hexágono interior
 sleutelwijdte bij TORX®-bouten	 ouvertures métriques pour vis TORX®	 medidas para tornillos TORX®
 Innensechskant Schon-Profil	 6 pans intérieur – profil d'usure	 hexágono interior, perfil protector
 binnenzeskant	 12 pans intérieur – profil d'usure	 estrella interior, perfil protector
 voor buiten-TORX®-schroeven	 pour vis TORX® extérieures	 para tornillos TORX® exteriores
 binnenvierkant	 carré femelle	 cuadradillo interior
 buitenvierkant	 carré mâle	 cuadradillo exterior
 buitenzeskant	 6 pans mâle	 hexágono exterior
 voor sleufschroeven	 pour vis à fente	 para tornillos ranurados
 voor kruiskopschroeven PHILLIPS-RECESS	 pour vis cruciformes PHILLIPS-RECESS	 para tornillos PHILLIPS-RECESS
 voor kruiskopschroeven POZIDRIV®	 pour vis cruciformes POZIDRIV®	 para tornillos POZIDRIV®
 voor spiebaanbouten RIBE CV	 pour vis à empreinte à créneaux RIBE CV	 para tornillos RIBE CV
 voor binnenvleelandsbouten XZN	 pour vis denture multiple XZN	 para tornillos XZN
 voor binnen-TAMPER-TORX®-schroeven	 pour vis TAMPER-TORX® intérieures	 para tornillos TAMPER-TORX® interiores
 voor binnen-TORX®-schroeven	 pour vis TORX® intérieures	 para tornillos TORX® interiores
POZIDRIV® gedeponerd handelsmerk van de firma European Industrial Services Ltd.	POZIDRIV® marque déposée par la société European Industrial Services Ltd.	POZIDRIV® marca registrada de European Industrial Services Ltd.
TORX® gedeponerd handelsmerk van de firma CAMCAR/TEXTRON INC.	TORX® marque déposée par la société CAMCAR/TEXTRON INC.	TORX® marca registrada de CAMCAR/TEXTRON INC.



HEYCO Qualitätswerkzeuge
GmbH & Co. KG
Birgden III/1
42855 Remscheid
Germany

Tel. +49 (0) 2191 205-0
Fax +49 (0) 2191 205-266
info@heyco.de
heyco-qualitaetswerkzeuge.de

  Folgen Sie uns
@heyco_qualitaetswerkzeuge