

HEYCO





PERFEKTION IM FOKUS FOCUS ON PERFECTION

Beste Qualität zu bieten, bestimmt maßgeblich unser Handeln und ist ein wichtiger Baustein unserer Firmenphilosophie. Für uns als verantwortungsvolles Familienunternehmen und für unsere Mitarbeiter ist dies eine Selbstverständlichkeit. Zertifizierungen nach international höchsten Standards bestätigen deshalb das HEYCO Qualitätsdenken. Unter Berücksichtigung der Kundenwünsche entstehen an den Produktionsstandorten auf dieser Grundlage qualitativ anspruchsvolle, technisch und wirtschaftlich ausgereifte Produkte.

In der über 80-jährigen Unternehmensgeschichte haben wir uns zu einem der führenden Werkzeughersteller entwickelt. Unser Fokus richtet sich darauf, unseren Kunden Produkte anzubieten, die gekennzeichnet sind durch ein Höchstmaß an Qualität und Gebrauchsnutzen. Dabei steht unser Name für Kompetenz, Innovationskraft und Flexibilität. Darauf vertrauen unsere Kunden und schätzen uns als zuverlässigen Partner. Auch zukünftig werden wir uns dafür einsetzen, mit innovativen Ideen den Anwender für unsere Werkzeuge zu begeistern.

Offering best quality is an important cornerstone of our corporate philosophy and is an essential factor all facets of our business activities. As a responsible family owned and managed company, this is a matter of course for us and our employees. Certification in accordance with the most stringent international standards underlines HEYCO's active commitment to quality. On this basis, technically mature and cost-effective products are manufactured in premium quality at the production sites under consideration of customer wishes.

In our company's more than 80-year history, we have developed to become one of the leading tool manufacturers. Our focus is set on offering our customers products that are distinguished by exceptional quality and usability. Due to this, our name has become a synonym for expertise, innovation and flexibility. Our customers place their trust in this and appreciate us as a reliable partner. We are actively committed to the ongoing development of innovative ideas that fire the enthusiasm of users for our tools.



Remscheid ist das Herz der deutschen Werkzeugindustrie. Dort wo einst durch Wasserkraft getriebene Werkzeuge geschmiedet wurden, erkannten die Brüder Max und Ernst Heynen die Chancen des Fortschritts. Mit Forschergeist und der Liebe zum Werkzeug legten sie 1937 den Grundstein für das Unternehmen HEYCO. Mit eigener Schmiede und dem Hammerwerk überzeugten sie von Anfang an durch ausgeprägtes Qualitätsdenken.

So wuchs das Stammhaus mit Verwaltung, Zentrallager und Versand beständig bis zu seiner heutigen Größe und liefert ihre Produkte weltweit in mehr als 70 Länder.

Neben der ursprünglichen Fertigung von Handwerkzeugen wurde ab 1980 das Fertigungsspektrum erweitert und HEYCO entwickelte sich zu einem führenden Lieferanten von Kunststoff- und Schmiedeteilen für die Automobilindustrie. Bei unseren Kunden sind wir als kompetenter Entwicklungspartner für das Modul- und Systemgeschäft anerkannt und für unsere Prototypenfertigung geschätzt. Mit stetiger Forschungs- und Entwicklungsarbeit schafft HEYCO die Voraussetzungen für die weitere Expansion im Sinne der Kunden.



Remscheid is the heart of the German toolmaking industry. Where water-wheels once drove the trip hammers and tools, the brothers Max and Ernst Heynen recognised the opportunities offered by progress. In 1937, their pioneering spirit and passion for tools led them to lay the foundation stone for HEYCO. Their absolute dedication to the quality of the products produced in their own forge and hammer mill convinced their customers from the start.

With the building of administration, warehousing and shipping facilities on the original site, the company constantly grew to its present size and shipped its products to more than 70 countries around the world.

In 1980, HEYCO began to diversify its portfolio as a manufacturer of hand tools and developed to become a leading supplier of plastic and forged components for the automotive industry. Our customers recognise us as a professional partner for development in the module and system sector and the construction of prototypes. HEYCO establishes the conditions for further expansion to the benefit of its customers with ongoing research and development activities.



Remscheid, Germany
Head office and administration
tool delivery, administration

Remscheid, Deutschland
Hauptsitz und Verwaltung
Werkzeugauslieferung, Administration

Ballina, Irland
Metall- und Kunststoffproduktion
Metal and plastics production

Titting, Deutschland
Metall- und Kunststoffproduktion, technische Entwicklung
Metal and plastics production, technical development

Bergisch-Born, Deutschland
IML- und Kunststoffproduktion IML
and plastics production

Pisek, Tschechien
Metall- und Kunststoffproduktion
Metal and plastics production

Emporia, USA Kunststoffproduktion/plastics production

Greenville, USA Verwaltung/administration



TRADITION TRIFFT FORTSCHRITT

TRADITION MEETS INNOVATION

Qualitätswerkzeuge
Quality tools

Schmiedekomponenten
Forged components

Technische Kunststoffprodukte
Technical plastic products

IML – In Mould Labeling
IML – In Mould Labeling

HEYCO-WERK Heynen GmbH & Co. KG , Remscheid
Hauptsitz und Verwaltung: Werkzeugauslieferung, Administration
Head office and administration: tool delivery, administration



8-29

Seite/page

SCHRAUBENSCHLÜSSEL
WRENCHES
CLÉS
LLAVES



30-99

Seite/page

STECKSCHLÜSSEL-PROGRAMM
SOCKETS
CLÉS À DOUILLES
LLAVES DE VASO



100-145

Seite/page

WERKZEUGSORTIMENTE
TOOL ASSORTMENTS
ASSORTIMENTS D'OUTILS
SURTIDOS DE HERRAMIENTAS

INHALT

CONTENTS

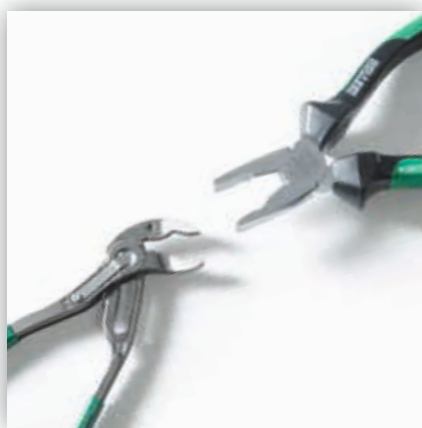

146-167

Seite/page

ZANGEN
PLIERS
PINCES
ALICATES



168-201

Seite/page

SCHRAUBENDREHER
SCREWDRIVERS
TOURNEVIS
DESTORNILLADORES



202-241

Seite/page

ALLGEMEINER WERKSTATTBEDARF
PRODUCTS FOR WORKSHOP
FOURNITURES GÉNÉRALES D'ATELIER
SUMINISTROS PARA TALLERES

242-249

Seite/page

PRÄSENTATIONSSYSTEME
PRODUCT PRESENTATION
SYSTÈMES DE PRÉSENTATION
SISTEMAS DE PRESENTACIÓN

250-267

Seite/page

INFORMATIONEN
INFORMATION
INFORMATIONS
INFORMACIONES

SCHRAUBENSCHLÜSSEL

WRENCHES

10-13 Seite/page

Doppelmaulschlüssel

Double ended open jaw wrenches
Clés à fourche
Llaves fijas de dos bocas abiertas

13-15 Seite/page

Einmaulschlüssel

Single ended open jaw wrenches
Clés à fourche simples
Llaves fijas de una boca abierta

16-21 Seite/page

Ringmaulschlüssel

Combination wrenches
Clés mixtes
Llaves combinadas

22-25 Seite/page

Doppelringschlüssel

Double ended ring wrenches
Clés polygonales
Llaves de estrella planas, de dos bocas

26-29 Seite/page

Spezialschlüssel

Special wrenches
Clés spéciales
Llaves especiales





350

DIN 3110 / ISO 1085

Doppelmaulschlüssel

Chrom-Vanadium

CP = verchromt, Köpfe poliert

Double ended open jaw wrenches

Chrome-Vanadium

CP = chromium plated, polished heads

Clés à fourche

Chrome-Vanadium

CP = chromées, têtes polies

Llaves fijas de dos bocas abiertas

Cromo Vanadio

CP = cromado, cabezas pulidas espejo

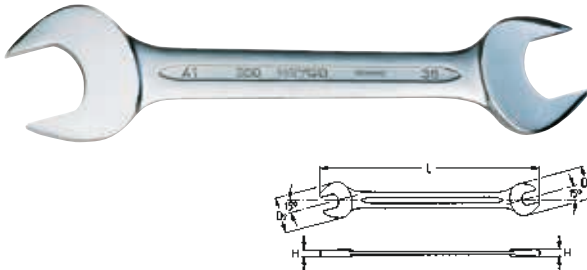

Code	⊗MM	←L→ mm	H mm	D ₁ mm	D ₂ mm	g		EAN
00350040582	4 x 5	103	3,3	11,6	13,7	10	10	008265
00350055582	5 x 5,5	104	3,3	13,7	14,7	10	10	008289
00350055782	5,5 x 7	122	3,6	15,7	17,7	20	10	008302
00350060782	6 x 7	122	3,6	15,7	17,7	20	10	008333
00350080982	8 x 9	140	3,9	20,8	22,9	32	10	008388
00350081082	8 x 10	140	3,9	20,8	22,9	31	10	008418
00350101182	10 x 11	156	4,8	23,9	26,9	54	10	008456
00350101282	10 x 12	156	4,8	23,9	26,9	53	10	008487
00350101382	10 x 13	172	5,3	24,0	30,0	67	10	008517
00350111382	11 x 13	172	5,3	28,0	31,0	65	10	008548
00350121382	12 x 13	172	5,3	28,0	31,0	61	10	008562
00350121482	12 x 14	172	5,3	28,0	31,0	59	10	008593
00350131482	13 x 14	190	5,7	32,5	34,9	92	10	008616
00350131582	13 x 15	190	5,7	32,5	34,9	91	10	008647
00350131682	13 x 16	190	5,7	32,5	34,9	90	10	008661
00350131782	13 x 17	204	5,9	32,1	38,2	110	10	008692
00350141582	14 x 15	190	5,7	32,5	34,9	90	10	008722
00350141782	14 x 17	204	5,9	32,1	38,2	105	10	008753
00350161782	16 x 17	204	5,9	36,1	39,2	105	10	008777
00350161882	16 x 18	204	5,9	36,1	39,2	105	10	008791
00350171982	17 x 19	223	6,5	40,2	42,3	155	10	008821
00350181982	18 x 19	223	6,5	40,2	42,3	150	10	008845
00350182182	18 x 21	236	6,8	40,2	46,4	180	10	008869
00350192282	19 x 22	236	6,8	44,9	48,4	190	10	008890
00350192482	19 x 24	250	7,3	42,3	52,5	230	10	008913
00350202282	20 x 22	236	6,8	44,9	48,4	185	10	008937
00350212382	21 x 23	250	7,3	47,4	51,5	265	5	008951
00350212482	21 x 24	250	7,3	47,4	51,5	260	5	008975
00350222482	22 x 24	250	7,3	47,4	51,5	260	5	009002
00350242682	24 x 26	265	7,8	52,5	58,6	320	5	009026
00350242782	24 x 27	265	7,8	52,5	58,6	310	5	009057
00350252882	25 x 28	280	8,1	55,2	61,3	350	5	009095
00350272982	27 x 29	280	8,1	58,6	64,4	360	5	009118
00350273082	27 x 30	280	8,1	58,6	64,4	355	5	009132
00350273282	27 x 32	302	8,6	59,7	69,9	455	5	009156
00350303282	30 x 32	302	8,6	64,8	70,3	480	5	009187
00350303482	30 x 34	302	8,6	64,8	72,9	510	5	009200
00350303682*	30 x 36	325	8,8	63,0	74,5	540	5	009224
00350323682	32 x 36	325	8,8	66,5	74,5	550	5	009231
00350364182	36 x 41	358	8,8	74,5	84,0	730	5	009248
00350414682	41 x 46	400	9,8	84,0	93,5	1000	5	009255
00350465082	46 x 50	450	10,8	93,5	105,0	1470	3	009262

Code	⊗AF	←L→ mm	H mm	D ₁ mm	D ₂ mm	g		EAN
00350660682	1/4 x 5/16	130	3,9	17,7	20,8	28	10	009279
00350660982	5/16 x 3/8	140	3,9	20,8	22,9	32	10	009286
00350661382	3/8 x 7/16	156	4,8	23,9	26,9	55	10	009293
00350661782	7/16 x 1/2	172	5,3	28,0	31,0	67	10	009316
00350661982	1/2 x 9/16	190	5,7	32,5	34,9	92	10	009323
00350662282	9/16 x 5/8	190	5,7	32,5	34,9	91	10	009347
00350662582	19/32 x 11/16	204	5,9	36,1	39,2	110	10	009354
00350662782	5/8 x 11/16	204	5,9	36,1	39,2	105	10	009361
00350662882	5/8 x 3/4	223	6,5	40,2	42,3	155	10	009378
00350663082	11/16 x 3/4	223	6,5	40,2	42,3	150	10	009385
00350663582	3/4 x 25/32	236	6,8	44,9	48,4	190	10	009392
00350663782	3/4 x 7/8	236	6,8	44,9	48,4	185	10	009408
00350664182	13/16 x 7/8	236	6,8	44,9	48,4	180	10	009415
00350664382	7/8 x 15/16	250	7,3	47,4	51,5	260	5	009422
00350664682	15/16 x 1	265	7,8	52,5	58,6	310	5	009439
00350665082	1 x 1.1/8	280	8,1	55,7	61,3	345	5	009453
00350665382	1.1/16 x 1.1/4	302	8,6	59,7	69,9	460	5	009460
00350665882*	1.3/16 x 1.5/16	302	8,6	64,8	70,3	470	5	009484
00350666082*	1.1/4 x 1.3/8	325	8,8	66,5	74,5	555	5	009507
00350666482*	1.5/16 x 1.1/2	325	8,8	66,5	74,5	540	5	009514
00350666882*	1.7/16 x 1.5/8	358	8,8	74,5	84,0	725	5	009521

B 350

Doppelmaulschlüssel-Satz

in Kartonverpackung

Double ended open jaw wrench set

in cardboard-carton

Jeux de clés à fourche

en carton à fenêtre

Juegos de llaves fijas de dos bocas abiertas

en estuche de cartón



Code	No.	MM				=1	g	EAN
00350844082	B 350-8-M	6 x 7	8 x 9	10 x 11	12 x 13	700	094350	
		14 x 15	16 x 17	18 x 19	20 x 22			

HP 350

Doppelmaulschlüssel-Satz

im Kunststoffhalter

Double ended open jaw wrench set

in plastic holder

Jeux de clés à fourche

sur présentoir-support en plastique

Juegos de llaves fijas de dos bocas abiertas

en clip de plástico



Code	No.	MM				=1	g	EAN
00350644082	HP 350-8-M	6 x 7	8 x 9	10 x 11	12 x 13	812	340006	
		14 x 15	16 x 17	18 x 19	20 x 22			

K 350



Doppelmaulschlüssel-Sätze

Double ended open jaw wrench sets

Jeux de clés à fourche

Juegos de llaves fijas de dos bocas abiertas



Code	No.	MM	 = 1	 g	EAN
00350942082	K 350-6-M-1	6 x 7 8 x 9 14 x 15 16 x 17	10 x 11 12 x 13 14 x 15	365	009675
00350942182	K 350-6-M-2	8 x 9 10 x 11 16 x 17 18 x 19	12 x 13 14 x 15	495	009682
00350942282	K 350-6-M-3	10 x 11 12 x 13 18 x 19 20 x 22	14 x 15 16 x 17	645	009699
00350943482	K 350-7-M	6 x 7 8 x 9 14 x 15 17 x 19	10 x 11 12 x 13 20 x 22	600	009712
00350943582	K 350-7-M-1	5,5 x 7 8 x 10 14 x 15 17 x 19	11 x 13 16 x 18 20 x 22	1345	129199
00350944082	K 350-8-M	6 x 7 8 x 9 14 x 15 16 x 17	10 x 11 12 x 13 18 x 19 20 x 22	700	009729
00350945582	K 350-10-M	6 x 7 8 x 9 14 x 15 16 x 17 21 x 23 24 x 27	10 x 11 12 x 13 18 x 19 20 x 22	1270	009736
00350945682	K 350-10-M-1	6 x 7 8 x 9 14 x 15 16 x 17 21 x 23 24 x 26	10 x 11 12 x 13 18 x 19 20 x 22	1280	163377
00350947082	K 350-12-M	6 x 7 8 x 9 14 x 15 16 x 17 21 x 23 24 x 27	10 x 11 12 x 13 18 x 19 20 x 22 25 x 28 30 x 32	2100	009743
00350947282	K 350-12-M-2	6 x 7 8 x 9 14 x 15 16 x 17 21 x 23 24 x 26	10 x 11 12 x 13 18 x 19 20 x 22 25 x 28 27 x 32	1995	366846
00350948082	K 350-13-M	6 x 7 8 x 9 14 x 15 16 x 17 21 x 23 24 x 26 30 x 32	10 x 11 12 x 13 18 x 19 20 x 22 25 x 28 27 x 32	2475	009750
00350948582	K 350-14-M	6 x 7 8 x 9 14 x 15 16 x 17 21 x 23 24 x 27 36 x 41 46 x 50	10 x 11 12 x 13 18 x 19 20 x 22 25 x 28 30 x 32	4300	009767
00350948682	K 350-14-M-1	6 x 7 8 x 9 14 x 15 16 x 17 21 x 23 24 x 26 36 x 41 46 x 50	10 x 11 12 x 13 18 x 19 20 x 22 25 x 28 30 x 32	4310	310559

K 350



Doppelmaulschlüssel-Sätze

Double ended open jaw wrench sets

Jeux de clés à fourche

Juegos de llaves fijas de dos bocas abiertas



Code	No.	AF	 = 1	 g	EAN
00350962082	K 350-6-AF-1	1/4 x 5/16 1/2 x 9/16 3/4 x 25/32	3/8 x 7/16 5/8 x 11/16 13/16 x 7/8	650	009774
00350962182	K 350-6-AF-2	3/8 x 7/16 5/8 x 11/16 13/16 x 7/8	1/2 x 9/16 3/4 x 25/32 15/16 x 1	935	009781
00350964082	K 350-8-AF	1/4 x 5/16 1/2 x 9/16 3/4 x 25/32 15/16 x 1	3/8 x 7/16 5/8 x 11/16 13/16 x 7/8 1.1/16 x 1.1/4	1420	009798
00350967082	K 350-12-AF	1/4 x 5/16 1/2 x 9/16 5/8 x 11/16 3/4 x 25/32 7/8 x 15/16 1 x 1.1/8	3/8 x 7/16 19/32 x 11/16 5/8 x 3/4 13/16 x 7/8 15/16 x 1 1.1/16 x 1.1/4	2290	009804

R 350

Doppelmaulschlüssel-Sätze

in Kunststoff-Rolltaschen, mit Riemen

Double ended open jaw wrench sets

in plastic wallets, with strap

Jeux de clés à fourche

en trousse plastique, avec lanière

Juegos de llaves fijas de dos bocas abiertas

en bolsas de plástico, con correa



Code	No.	MM	=1				g	EAN
00350744082	R 350-8-M	6 x 7 14 x 15	8 x 9 16 x 17	10 x 11 18 x 19	12 x 13 20 x 22	820	009644	
00350747082	R 350-12-M	6 x 7 14 x 15 21 x 23	8 x 9 16 x 17 24 x 27	10 x 11 18 x 19 25 x 28	12 x 13 20 x 22 30 x 32	2355	009651	
00350747182	R 350-12-M-1	6 x 7 14 x 15 21 x 23	8 x 9 16 x 17 24 x 26	10 x 11 18 x 19 25 x 28	12 x 13 20 x 22 30 x 32	2365	163735	

Code	No.	AF	=1		g	EAN
00350767082	R 350-12-AF	1/4 x 5/16 1/2 x 9/16 5/8 x 11/16 3/4 x 25/32 7/8 x 15/16 1 x 1.1/8	3/8 x 7/16 19/32 x 11/16 5/8 x 3/4 13/16 x 7/8 15/16 x 1 1.1/16 x 1.1/4		2545	009668

894

DIN 894 / ISO 3318

Einmaulschlüssel

PH = phosphatiert

Single ended open jaw wrenches

PH = phosphated

Clés à fourche simples

PH = phosphatées

Llaves fijas de una boca abierta

PH = fosfatado

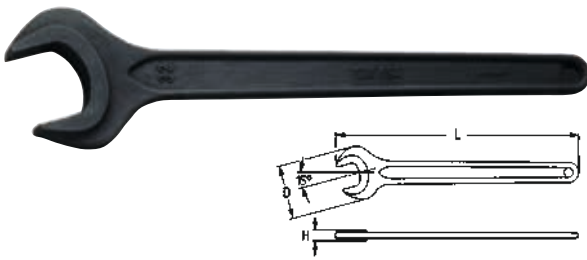

Code	MM	←L→ mm	H mm	D mm	g		EAN
00894006036	6	73	3,0	15,0	8	10	019537
00894007036	7	77	3,2	17,0	10	10	019544
00894008036	8	94	3,4	19,0	13	10	019551
00894009036	9	99	3,9	20,5	16	10	019568
00894010036	10	105	4,4	22,0	20	10	019575
00894011036	11	111	4,9	24,5	23	10	019582
00894012036	12	124	4,9	26,0	26	10	019599
00894013036	13	125	5,1	28,5	35	10	019605
00894014036	14	140	5,4	30,0	47	10	019612
00894015036	15	141	5,4	32,5	47	10	019629
00894016036	16	150	5,6	34,0	55	10	442922
00894017036	17	155	5,9	35,5	65	10	019636
00894019036	19	170	6,9	40,0	83	10	019650
00894022036	22	193	7,9	46,0	105	10	019667
00894024036	24	215	8,9	50,0	150	10	019674
00894027036	27	238	9,8	56,0	200	5	019681
00894030036	30	261	10,8	62,0	265	5	019698
00894032036	32	273	11,8	66,5	295	5	019704
00894034036	34	278	10,8	63,5	334	5	442649
00894036036	36	300	12,8	74,0	425	5	019711
00894038036	38	301	13,3	78,0	440	5	019728
00894041036	41	335	13,8	83,5	560	5	019735
00894046036	46	369	14,8	93,0	710	5	019742
00894050036	50	401	15,8	101,0	950	5	019759
00894055036	55	445	16,8	111,5	1200	3	019766
00894060036	60	480	17,8	122,0	1450	1	019773
00894065036	65	518	18,7	131,5	1875	1	019780
00894070036	70	557	19,7	141,5	2275	1	019797
00894075036	75	595	20,7	152,0	2700	1	019803
00894080036	80	645	22,0	162,2	3000	1	435405
00894085036	85	690	23,0	173,0	3400	1	435443
00894090036	90	690	23,0	173,0	3200	1	435450
NEU 00894095036	95	670	16,0	182,0	3500	1	459999
NEU 00894100036	100	722	17,0	195,0	5500	1	460001
NEU 00894105036	105	722	25,0	217,0	5800	1	460018
NEU 00894110036	110	872			6000	1	460025

895

DIN 895 / ISO 3318

Doppelmaulschlüssel

PH = phosphatiert

Double ended open jaw wrenches

PH = phosphated

Clés à fourche

PH = phosphatées

Llaves fijas de dos bocas abiertas

PH = fosfatado

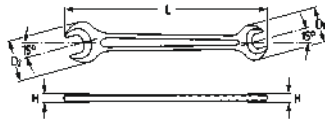

Code	MM	←L→ mm	H mm	D ₁ mm	D ₂ mm	g		EAN
00895060736	6 x 7	95	3,2	14,5	17,0	15	10	019933
00895080936	8 x 9	110	4,0	19,0	20,5	20	10	019957
00895081036	8 x 10	115	4,4	19,0	22,5	25	10	019964
00895091036	9 x 10	120	4,4	20,5	22,5	25	10	019971
00895091136	9 x 11	120	4,9	20,5	24,0	28	10	019988
00895101136	10 x 11	120	4,9	22,5	24,0	28	10	019995
00895101336	10 x 13	115	5,1	22,5	28,5	35	10	020014
00895101436	10 x 14	140	5,4	22,5	30,0	40	10	020045
00895111336	11 x 13	135	5,4	24,0	28,5	43	10	020052
00895121336	12 x 13	140	5,4	26,0	28,5	45	10	020069
00895121436	12 x 14	140	5,4	26,0	30,0	45	10	020076
00895131436	13 x 14	140	5,4	28,5	30,0	48	10	020083
00895131536	13 x 15	140	5,4	28,5	32,0	50	10	020090
00895131736	13 x 17	155	5,9	28,5	36,0	70	10	020106
00895141536	14 x 15	140	5,4	30,0	32,0	50	10	020113
00895141736	14 x 17	155	5,9	30,0	36,0	68	10	020120
00895161736	16 x 17	155	5,9	34,0	36,0	73	10	020137
00895161836	16 x 18	165	5,9	34,0	38,5	80	10	020144
00895171936	17 x 19	170	6,9	36,0	40,0	90	10	020151
00895172136	17 x 21	190	7,9	36,0	43,5	105	10	020168
00895172236	17 x 22	190	7,9	36,0	46,0	125	10	020175
00895192236	19 x 22	195	7,9	40,0	46,0	140	10	020182
00895192436	19 x 24	205	8,8	40,0	50,0	165	10	020199
00895212336	21 x 23	215	8,4	43,5	48,0	170	5	020205
00895222436	22 x 24	220	8,7	46,0	50,0	180	5	020212
00895222736	22 x 27	230	9,8	46,0	56,0	225	5	020229
00895242736	24 x 27	240	9,8	50,0	56,0	245	5	020236
00895242936	24 x 29	265	10,8	50,0	59,0	280	5	020243
00895243036	24 x 30	265	10,8	50,0	62,0	280	5	020250
00895273236	27 x 32	270	11,8	56,0	65,5	340	5	020267
00895303236	30 x 32	275	11,8	62,0	65,5	400	5	020274
00895303636	30 x 36	305	12,8	62,0	73,5	480	5	020281
00895323636	32 x 36	305	12,8	65,5	73,5	480	5	020298
00895364136	36 x 41	340	13,8	73,5	84,0	710	5	020304
00895414636	41 x 46	380	14,8	84,0	93,5	935	5	020311
00895465036	46 x 50	420	15,8	93,5	101,5	1210	3	020328
00895505536	50 x 55	460	16,8	101,5	111,0	1500	1	020335
00895556036	55 x 60	500	17,8	111,0	122,5	1860	1	020342
00895657020	65 x 70	580	20,0	132,0	142,0	2600	1	020359
00895758020	75 x 80	662	22,0	152,0	162,0	4100	1	020397

K 895

Doppelmaulschlüssel-Sätze

Double ended open jaw wrench sets

Jeux de clés à fourche

Juegos de llaves fijas de dos bocas abiertas



Code	No.	MM		g	EAN
00895942036	K 895-6-M-1	6 x 7 8 x 9 14 x 15 16 x 17	12 x 13	230	020403
00895942136	K 895-6-M-2	8 x 9 10 x 11 16 x 18 17 x 19	12 x 13 14 x 15	315	020410
00895942236	K 895-6-M-3	10 x 11 12 x 13 17 x 19 19 x 22	14 x 15 16 x 18	435	020427
00895944036	K 895-8-M	6 x 7 8 x 9 10 x 11 14 x 15 16 x 18 17 x 19	12 x 13 19 x 22	470	020434
00895947036	K 895-12-M	6 x 7 8 x 9 10 x 11 14 x 15 16 x 18 17 x 19	12 x 13 19 x 22 21 x 23 22 x 27 24 x 29 30 x 32	1545	020441

380

Klauenschlüssel

Chrom-Vanadium
C = verchromt
Betätigung mit Drehstift HEYCO 900

Crowfoot wrenches

Chrome-Vanadium
C = chromium plated
to be used with tommy bar HEYCO 900

Clés à griffe

Chrome-Vanadium
C = chromées
à utiliser avec broche HEYCO 900

Llaves de boca fija abierta, tipo garra

Cromo Vanadio
C = cromado
a usar con pasador HEYCO 900

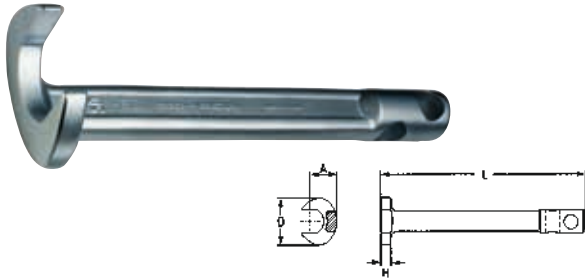

Code	Ø MM	←L→ mm	D mm	H mm	A mm	für/for	g	g	EAN
00380001380	13	160	28	5,5	16,5	900-8	100	5	009880
00380001480	14	160	28	5,5	17,5	900-8	100	5	009897
00380001780	17	200	33	6	20,0	900-10	150	5	009903
00380001980	19	200	37	7	22,0	900-12	250	5	009910
00380002280	22	200	46	8	26,0	900-12	300	5	009927
00380002480	24	250	46	9	28,5	900-14	450	5	009934
00380002780	27	250	52	10	32,0	900-14	500	5	009941
00380003080	30	250	57	11	34,0	900-16	650	5	009958
00380003280	32	250	61	12	37,0	900-16	700	5	009965
00380003680	36	315	68	13	42,5	900-18	1150	3	009989
00380004180	41	315	76	14	48,0	900-18	1230	3	009996
00380005080*	50	315	92	15	56,0	900-20	1600	1	010039

Die benötigten Drehstifte finden Sie auf Seite 99.
The required rotary pins can be found on page 99.

390

DIN 3117 A / 3117 B

Verstellbare Einmaulschlüssel

Chrom-Vanadium
PHS = phosphatiert, Kopf geschliffen
schwedisches Modell, linksgängig, Maulstellung 15°, DIN 3117 A

Adjustable wrenches

Chrome-Vanadium
PHS = phosphated, ground head
Swedish pattern, left hand movement, 15° head angle, DIN 3117A

Clés à molette

Chrome-Vanadium
PHS = phosphatées, tête meulée
modèle suédois, mouvement à gauche, angle de la tête 15°, DIN 3117A

Llaves ajustables

Cromo Vanadio
PHS = fosfatado, cabeza amolada
modelo sueco, giro a la izquierda, ángulo de boca 15°, DIN 3117 A

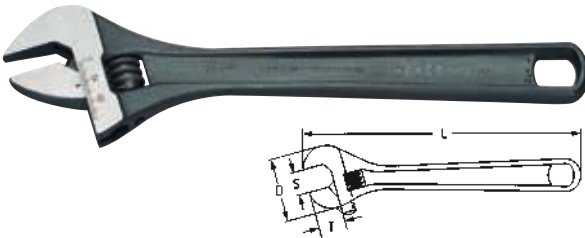

Code	PHS	←L→		S		T	D	g	g	EAN
		mm	"	mm	"					
00390000437		115	4	13	1/2	13,5	35,0	52	1	010084
00390001037*		259	10	34	1.3/8	28,0	74,0	430	1	010152
00390001237*		311	12	39	1.1/2	33,0	84,0	710	1	010176
00390001537*		386	15	43,12	1.11/16	42,5	106,0	1290	1	010190
00390001837*		462	18	53	2.1/8	51,0	124,0	2040	1	010213

390

DIN 3117 A / 3117 B

Verstellbare Einmaulschlüssel

Chrom-Vanadium, CP = verchromt, Kopf poliert
amerikanisches Modell, rechtsgängig, Maulstellung 22°, DIN 3117 B

Adjustable wrenches

Chrome-Vanadium, CP = chromium plated, polished head
American pattern, right hand movement, 22° head angle, DIN 3117 B

Clés à molette

Chrome-Vanadium, CP = chromées, tête polie
modèle américain, mouvement à droite, angle de la tête 22°, DIN 3117 B

Llaves ajustables

Cromo Vanadio, CP = cromado, cabeza pulida espejo
modelo americano, giro a la derecha, ángulo de boca 22°, DIN 3117 B

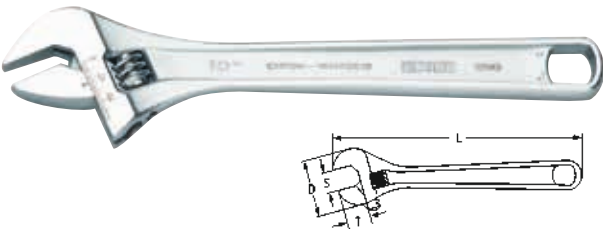

Code	CP	←L→		S		T	D	g	g	EAN
		mm	"	mm	"					
00390000482		115	4	13	1/2	13,5	35,0	52	1	010091
00390000682		161	6	24	15/16	19,5	50,0	130	1	010114
00390000882		207	8	30	1.3/16	24,0	62,0	265	1	010145
00390001082		259	10	34	1.3/8	28,0	74,0	430	1	010169
00390001282		311	12	39	1.1/2	33,0	84,0	710	1	010183
00390001582		386	15	43,12	1.11/16	42,5	106,0	1290	1	010206
00390001882		462	18	53	2.1/8	51,0	124,0	2040	1	010220

maxline 410

HERVORRAGEND IN FORM
UND HART IM NEHMEN

Klassische Legierungen haben einen guten Ruf. Ohne Zweifel. Gewohnt, Gutes immer wieder zu verbessern, schmieden wir hochwertigen Chrom-Vanadium-Stahl zur Schlüsselgeneration **maxline**. Ein starkes Stück Werkzeug, das bei aller Eleganz und Leichtigkeit selbst außergewöhnlichen Belastungen moderner Verschraubungstechniken spielend gewachsen ist.

Das Ergebnis liegt vor Ihnen. Leicht, schlank und bärenstark. Die sympathisch feine Oberfläche harmoniert aufs Beste mit der angenehmen, griff-sicheren Struktur.

Die nach DIN 899 geforderte Drehmomentbelastbarkeit haben wir nicht nur erreicht, sondern weit übertroffen. Mit viel Erfahrung, CAD, erstklassigem Werkstoff und den gewohnt präzisen Fertigungsverfahren.

Schraubenköpfe leben länger.

Das spezielle **maxline**-Profil setzt mit Doppel-Sechskant an den Flächen, nicht an den Kanten der Schraubenköpfe an. Dadurch werden zum einen die Schraubenkanten geschont, zum anderen sind Schlüssel und Schraube höher belastbar. Eine positive Auswirkung auf die erheblich längere Lebensdauer beider Beteiligten.



TOUGH TOOLS. TOMORROW'S DESIGN

Classic alloys have a good reputation, no doubt about it. We have a tradition of improving on good ideas. That's why we use top-quality chrome vanadium steel to forge **maxline**. The new generation of wrenches. Don't be fooled by good looks and light weight. These tough tools are more than a match for the high torque demands on today's bolted joints. See the following sections for more details.

You're looking at the result: light, trim, tough. So we gave these tools our new HEYCO finish. The tough abrasive surface blends in perfectly with the comfortable, non-slip grip.

We not only designed our tools to withstand the torque load required by DIN 899. We went a step further and practically doubled that torque. With a world of experience, CAD technology, first-class materials and the precision engineering we're famous for.

Bolt heads last longer.

With its double hex box design, the special **maxline** profile applies force to the full surface of the bolt head, not to the outer edges. This has the double advantage of reducing wear on the bolt while increasing the load tolerance of both wrench and bolt. And this makes it easier for everyone.

EN PLEINE FORME ET DURS À LA TÂCHE

Les alliages classiques ont bonne réputation. Sans aucun doute. Habitué à améliorer constamment ce qui est déjà bien, nous forgerons désormais **maxline**, la nouvelle génération de clés, à partir d'un acier de haute qualité au chrome-vanadium. Malgré son élégance et sa légèreté, cet outil puissant maîtrise facilement les sollicitations les plus extrêmes des techniques de vissage modernes. Vous en lisez plus ci-dessous. Réduction de la matière aux endroits peu sollicités, apport aux endroits critiques. Léger, mince et superpuissant. La surface à l'aspect sympathique et pur s'harmonise au mieux avec la structure antidérapante agréable au toucher.

Ce n'est pas seulement la capacité de sollicitation au couple exigée par la norme DIN 899 que nous avons atteinte, mais presque le double. Grâce à notre grande expérience, à la C.A.O., à une matière de toute première qualité et à la précision habituelle de nos procédés de fabrication.

Longévité accrue des têtes de vis

Avec son six pans double, le profil spécial de **maxline** saisit les têtes de vis par les faces et non par les angles. Cela permet de ménager les angles des têtes de vis tout en exerçant une sollicitation plus élevée sur la clé et sur la vis. Un effet positif pour une longévité accrue de la vis et de l'outil.

AVANZADO DISEÑO Y SUPERIOR RENDIMIENTO

Fiel a nuestra costumbre de constantes mejoras, forjamos la nueva línea **maxline** de acero al cromo vanadio extra, calidad. Una gran herramienta que a pesar de su forma estilizada aguanta los elevados pares de apriete exigidos incluso en condiciones extremas.

El resultado está a la vista: Una llave ligera, elegante y de superior resistencia.

Sustituyendo dos tipos de llaves, las de boca abierta y las de boca estrella acodada, le ahorran dinero y sitio en su caja de herramientas.

Pero nosotros no solamente cumplimos con los pares de apriete exigidos por la norma DIN 899, sino casi los doblamos, gracias a la experiencia de muchos años, diseño por ordenador, acero de calidad y técnicas de fabricación de gran precisión.

La vida de las tuercas se alarga.

El perfil especial **maxline** de la boca estrella ejerce la presión sobre los planos del exágono de la tuerca, no en los cantos. Gracias a ello, los cantos no se redondean, pudiéndose aplicar pares de apriete superiores. El resultado es una mayor duración tanto de la tuerca como de la llave.



410

DIN 3113 B/ISO 3318 · ISO 7738



Ringmaulschlüssel *maxline*

Hochwertiger Chrom-Vanadium-Stahl
CPP = verchromt, ganz poliert

Combination wrenches *maxline*

High-grade Chrome-Vanadium steel
CPP = chromium plated, fully polished

Jeux de clés mixtes *maxline*

Un acier au Chrome-Vanadium
CPP = chromées, entièrement polies

Juegos de llaves combinadas *maxline*

Acero al cromo vanadio
CPP = cromado, enteramente pulido espejo

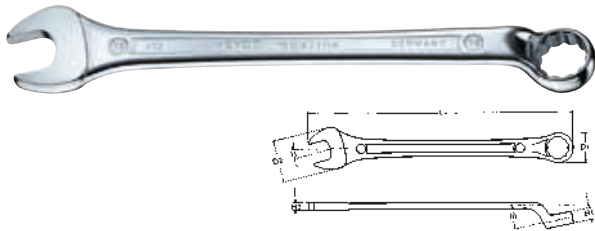

Code	MM	L mm	H ₁ mm	H ₂ mm	D ₁ mm	D ₂ mm	g	g	EAN
00410010083	10	149	6,9	4,9	15,7	21,9	49	10	097030
00410011083	11	161	7,4	5,2	16,8	23,9	60	10	097047
00410012083	12	173	7,8	5,5	18,1	25,9	74	10	097054
00410013083	13	185	8,3	5,9	19,4	28,0	88	10	097061
00410014083	14	197	8,8	6,1	20,7	30,0	100	10	097078
00410015083	15	209	9,2	6,4	21,9	32,1	120	10	097085
00410016083	16	221	9,7	6,7	23,1	34,2	145	10	097092
00410017083	17	233	10,2	7,0	24,3	36,1	165	10	097108
00410018083	18	245	10,7	7,3	25,7	38,2	185	10	097115
00410019083	19	257	11,2	7,6	27,1	40,3	215	10	097122
00410020083	20	269	11,6	7,8	28,4	42,3	245	10	097139
00410021083	21	281	12,0	8,2	29,7	44,4	275	5	097146
00410022083	22	293	12,5	8,5	31,1	46,3	315	5	097153
00410024083	24	317	13,5	9,1	33,8	50,4	390	5	097160
00410027083	27	352	14,8	9,9	37,8	56,1	530	5	097177
00410030083	30	388	16,3	10,9	41,8	61,6	675	5	097184
00410032083	32	412	17,2	11,4	44,5	65,5	830	5	097191
00410034083	34	436	18,2	12,0	47,3	69,3	1025	3	097207
00410036083	36	460	19,1	12,6	49,9	73,1	1145	3	097214
00410041083	41	520	21,5	14,1	56,6	82,6	1640	3	097221

K 410

DIN 3113 B/ISO 3318 · ISO 7738

Ringmaulschlüssel-Sätze *maxline*

Combination wrench sets *maxline*

Jeux de clés mixtes *maxline*

Juegos de llaves combinadas *maxline*



Code	No.	MM	g	EAN
00410945083	K 410-9-M	10 13 16 17 18 19 21 22 24	1830	100853
00410946083	K 410-11-M	10 13 16 17 18 19 21 22 24 27 30	3035	100860
00410948583	K 410-14-M	10 11 12 13 14 15 16 17 18 19 20 21 22 24	2440	100877

400

Ringmaulschlüssel

Chrom-Vanadium

DIN 3113 A/ISO 3318 · ISO 7738

CP = verchromt, Kopf und Ring poliert
5,5 – 50 mm · AF 1/4 – 2

DIN 3113 B/ISO 3318 · ISO 7738

C = verchromt

55 – 80 mm · AF 2.1/8 – 2.7/16

Combination wrenches

Chrome-Vanadium

DIN 3113 A/ISO 3318 · ISO 7738

CP = chromium plated, polished head and ring
5,5 – 50 mm · AF 1/4 – 2

DIN 3113 B/ISO 3318 · ISO 7738

C = chromium plated

55 – 80 mm · AF 2.1/8 – 2.7/16

Clés mixtes

Chrome-Vanadium

DIN 3113 A/ISO 3318 · ISO 7738

CP = chromées, têtes polies

5,5 – 50 mm · AF 1/4 – 2

DIN 3113 B/ISO 3318 · ISO 7738

C = chromées

55 – 80 mm · AF 2.1/8 – 2.7/16

Llaves combinadas

Cromo Vanadio

DIN 3113 A/ISO 3318 · ISO 7738

CP = cromado, cabezas pulidas espejo
5,5 – 50 mm · AF 1/4 – 2

DIN 3113 B/ISO 3318 · ISO 7738

C = cromado

55 – 80 mm · AF 2.1/8 – 2.7/16



DIN 3113 A/ISO 3318 · ISO 7738

CP



DIN 3113 B/ISO 3318 · ISO 7738

C

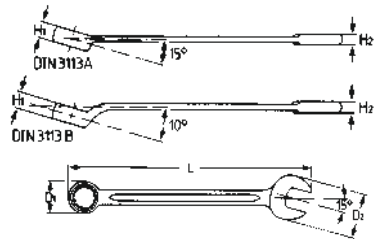

Code	CP	MM	L mm	H ₁ mm	H ₂ mm	D ₁ mm	D ₂ mm	g	g	EAN
0040005582		5,5	100	5,0	3,9	10,1	15,7	14	10	010282
0040006082		6	100	5,0	3,9	10,1	15,7	14	10	010299
0040007082		7	110	5,5	4,2	11,5	17,0	16	10	010312
0040008082		8	120	5,9	4,4	12,9	19,0	23	10	010336
0040009082		9	130	6,4	4,7	14,5	20,9	33	10	010350
00400010082		10	140	6,9	5,0	15,9	22,8	40	10	010381
00400011082		11	150	7,4	5,2	17,3	25,4	48	10	010404
00400012082		12	160	7,9	5,5	18,7	26,7	58	10	010435
00400013082		13	170	8,4	5,8	20,2	29,3	63	10	010466
00400014082		14	180	8,9	6,1	21,6	31,2	88	10	010497
00400015082		15	190	9,3	6,3	23,1	33,0	97	10	010527
00400016082		16	200	9,8	6,6	24,6	34,5	105	10	010558
00400017082		17	210	10,3	6,9	25,4	37,3	135	10	010589
00400018082		18	220	10,8	7,1	27,4	38,4	145	10	010602
00400019082		19	230	11,1	7,3	28,8	40,4	155	10	010633
00400020082		20	240	11,4	7,5	30,2	42,3	175	10	010657
00400021082		21	250	11,7	7,7	31,7	44,2	200	10	010664
00400022082		22	260	12,0	7,9	33,0	46,6	230	10	010695
00400023082		23	270	12,4	8,1	34,5	48,8	255	10	010701
00400024082		24	280	12,7	8,3	35,8	50,1	280	5	010718
00400025082		25	290	13,0	8,5	37,3	52,8	300	5	010725
00400026082		26	300	13,3	8,7	38,7	53,9	335	5	010732
00400027082		27	310	13,6	8,9	40,2	55,9	375	5	010749
00400028082		28	320	13,9	9,1	41,5	57,8	400	5	010756
00400029082		29	330	14,2	9,3	42,8	59,8	440	5	010763
00400030082		30	340	14,6	9,5	44,3	62,6	490	5	010770
00400032082		32	360	15,2	9,9	47,2	66,9	590	5	010787
00400034082		34	380	15,8	10,3	50,1	69,5	680	5	010794
00400036082		36	400	22,8	14,1	54,6	77,5	1090	5	010800
00400038082		38	400	22,8	14,1	54,6	77,5	1070	5	010817
00400041082		41	450	25,8	15,8	62,1	83,7	1450	3	010824
00400046082		46	500	28,8	17,5	69,6	93,1	1960	1	010831
00400050082		50	540	31,2	18,9	75,6	102,6	2600	1	010848

Code	C	MM	L mm	H ₁ mm	H ₂ mm	D ₁ mm	D ₂ mm	g	g	EAN
00400055080		55	610	28,2	18,0	84,5	113,0	2850	1	010855
00400060080		60	660	31,0	20,0	90,0	123,0	3600	1	010862
00400065080		65	710	33,0	22,0	98,0	133,0	4550	1	010879
00400070080		70	760	35,0	24,0	105,0	143,0	5800	1	010886
00400075080		75	810	38,0	26,0	110,0	153,0	6650	1	010893
00400080080		80	860	41,0	28,0	119,0	163,0	8500	1	010909

Code	CP	AF	L mm	H ₁ mm	H ₂ mm	D ₁ mm	D ₂ mm	g	g	EAN
00400631282		1/4	100	5,0	3,9	10,1	15,7	14	10	010916
00400631682		5/16	120	5,9	4,4	12,9	19,0	23	10	010923
00400631982		3/8	140	6,9	5,0	15,9	22,8	41	10	010947
00400632182		7/16	150	7,4	5,2	17,3	25,4	48	10	010961
00400632382		1/2	170	8,4	5,8	20,2	29,3	64	10	010985
00400632582		9/16	180	8,9	6,1	21,6	31,2	88	10	011005
00400632682		19/32	190	9,3	6,3	23,1	33,0	97	10	011012
00400632782		5/8	200	9,8	6,6	24,6	34,5	105	10	011029
00400632982		11/16	210	10,3	6,9	25,9	37,3	135	10	011043
00400633182		3/4	230	11,1	7,3	28,8	40,4	155	10	011050
00400633282		25/32	240	11,4	7,5	30,2	42,3	175	10	011067
00400633382		13/16	250	11,7	7,7	31,7	44,2	205	10	011074
00400633482		7/8	260	12,0	7,9	33,0	46,6	230	10	011081
00400633582		15/16	280	12,7	8,3	35,8	50,1	285	5	011098
00400633782		1	290	13,0	8,5	37,3	52,8	295	5	011104
00400633882		1.1/16	310	13,6	8,9	40,2	55,9	375	5	011111
00400633982		1.1/8	330	14,2	9,3	42,8	59,8	445	5	011128
00400634182		1.1/4	360	15,2	9,9	47,2	66,9	595	5	011135
00400634282		1.5/16	360	15,2	9,9	47,2	66,9	580	5	011142
00400634382		1.3/8	400	22,8	14,1	54,6	77,5	1165	5	011159
00400634482		1.7/16	400	22,8	14,1	54,6	77,5	1080	5	011166
00400634582		1.1/2	400	22,8	14,1	54,6	77,5	1060	3	011173
00400634782		1.5/8	450	25,8	15,8	62,1	83,7	1450	3	011180
00400634982		1.3/4	500	28,8	17,5	69,6	93,1	2020	1	011197
00400635082		1.13/16	500	28,8	17,5	69,6	93,1	1960	1	011203
00400635282		2	540	31,2	18,9	75,6	102,6	2600	1	011210

Code	C	AF	L mm	H ₁ mm	H ₂ mm	D ₁ mm	D ₂ mm	g	g	EAN
00400635580		2.3/16	610	31,2	18,0	84,5	113,0	2750	1	011234
00400635780		2.5/16	660	31,2	20,0	90,0	122,0	3700	1	011258
00400635880*		2.3/8	660	31,2	20,0	90,0	122,0	3600	1	011265

B 400

Ringmaulschlüssel-Sätze

in Kartonverpackung

Combination wrench sets

in cardboard-carton

Jeux de clés mixtes

en carton à fenêtre

Juegos de llaves combinadas

en estuche de cartón



Code	No.	MM	=1	g	EAN
00400824082	B 400-8-M	6 7 8 9 10 13 17 19		480	094374
00400827082	B 400-12-M	8 9 10 11 12 13 14 15 16 17 18 19		990	094381

K 400

Ringmaulschlüssel-Sätze

Combination wrench sets

Jeux de clés mixtes

Juegos de llaves combinadas



Code	No.	MM	=1	g	EAN
00400924082	K 400-8-M	6 7 8 9 10 13 17 19		480	011470
00400924382	K 400-8-M-2	10 12 13 14 17 19 22 24		1031	366853
00400925582	K 400-10-M	8 9 10 11 12 13 14 17 19 22		875	011487
00400927082	K 400-12-M	8 9 10 11 12 13 14 15 16 17 19 22		1075	011494
00400927282	K 400-12-M-2	6 7 8 9 10 11 12 13 14 17 19 22		905	011524
00400927582	K 400-12-M-3	10 11 12 13 14 17 19 22 24 27 30 32		2468	366877
00400928582	K 400-14-M	8 9 10 11 12 13 14 15 16 17 19 21 22 24		1527	366211
00400928982	K 400-15-M	6 7 8 9 10 11 12 13 17 19 22 24 27 30 32		2550	011548
00400928882	K 400-16-M	6 7 8 10 11 12 13 14 15 17 19 22 24 27 30 32		2524	366228
00400929082	K 400-17-M	6 7 8 9 10 11 12 13 14 15 16 17 18 19 20 21 22		1450	011555
00400929582	K 400-22-M	8 9 10 11 12 13 14 15 16 17 18 19 20 21 22 23 24 26 27 28 30 32		4320	011562
00400929882	K 400-26-M	6 7 8 9 10 11 12 13 14 15 16 17 18 19 20 21 22 23 24 25 26 27 28 29 30 32		5090	011579

Code	No.	AF	=1	g	EAN
00400932082	K 400-6-AF	3/8 7/16 1/2 9/16 5/8 3/4		500	011586
00400934082	K 400-8-AF	5/16 3/8 7/16 1/2 9/16 5/8 11/16 3/4		660	011593
00400935582	K 400-10-AF	5/16 3/8 7/16 1/2 9/16 5/8 11/16 3/4 13/16 7/8		1095	011609
00400937082	K 400-12-AF	5/16 3/8 7/16 1/2 9/16 5/8 11/16 3/4 13/16 7/8 15/16 1		1675	011616
00400939082	K 400-17-AF	1/4 5/16 3/8 7/16 1/2 9/16 19/32 5/8 11/16 3/4 25/32 13/16 7/8 15/16 1 1.1/16 1.1/4		2930	011623
00400939582	K 400-22-AF	1/4 5/16 3/8 7/16 1/2 9/16 19/32 5/8 11/16 3/4 25/32 13/16 7/8 15/16 1 1.1/16 1.1/8 1.1/4 1.5/16 1.3/8 1.7/16 1.1/2		7260	011630

HP 400

Ringmaulschlüssel-Satz

im Kunststoffhalter

Combination wrench set

in plastic holder

Jeux de clés mixtes

sur présentoir-support en plastique

Juegos de llaves combinadas

en clip de plástico



Code	No.	MM	=1	g	EAN
00400627382	HP 400-12-M	6 8 10 11 12 13 14 15 16 17 18 19		1070	340419

R 400

Ringmaulschlüssel-Sätze

in Kunststoff-Rolltaschen mit Riemen

Combination wrench sets

in plastic wallets, with strap

Jeux de clés mixtes

en trousse plastique, avec lanière

Juegos de llaves combinadas

en bolsas de plástico, con correa



Code	No.	MM	=1	g	EAN
00400724082	R 400-8-M	6 7 8 9 10 13 17 19		605	011388
00400727182	R 400-12-M-1	8 9 10 11 12 13 14 15 16 17 18 19		1160	113853
00400727282	R 400-12-M-2	6 7 8 9 10 11 12 13 14 17 19 22		1075	011395
00400728082	R 400-13-M	10 11 12 13 14 15 16 17 18 19 20 21 22		1725	011401
00400728182	R 400-13-M-2	6 7 8 9 10 11 12 13 14 15 17 19 22		1185	011418

Code	No.	AF	=1	g	EAN
00400734082	R 400-8-AF	5/16 3/8 7/16 1/2 9/16 5/8 11/16 3/4		785	011425
00400737082	R 400-12-AF	5/16 3/8 7/16 1/2 9/16 5/8 11/16 3/4 13/16 7/8 15/16 1		1840	011432
00400738082	R 400-13-AF	1/4 5/16 3/8 7/16 1/2 9/16 5/8 11/16 3/4 13/16 7/8 15/16 1		1875	011449

430

Starter- und Blockschlüssel

Chrom-Vanadium, CP = verchromt
Ringe poliert

Starter and manifold wrenches

Chrome-Vanadium, CP = chromium plated
polished rings

Clés polygonales demi-lune

Chrome-Vanadium, CP = chromées
têtes polies

Llaves de estrella de dos bocas, para motor de arranque

Cromo Vanadio, CP = cromado
cabezas pulidas espejo

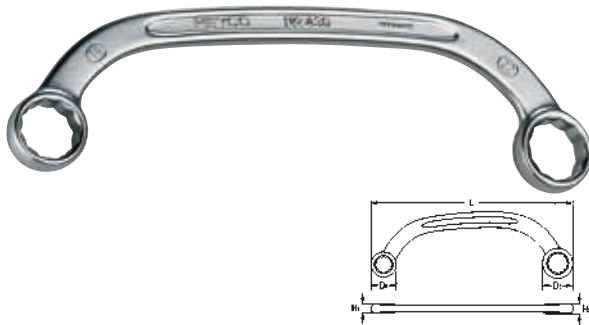

Code	MM	L mm	H ₁ mm	H ₂ mm	D ₁ mm	D ₂ mm	g	g	EAN
00430111382	11 x 13	150	6,8	7,0	17,9	20,8	70	5	011678
00430141682	14 x 16	185	8,2	8,4	23,8	26,7	110	5	011685
00430141782	14 x 17	185	8,2	8,4	23,8	26,7	105	5	011692
00430192282	19 x 22	235	11,3	11,0	29,8	34,3	225	5	011715

450

DIN 837 / ISO 1085

Doppelringschlüssel

Chrom-Vanadium, CP = verchromt, Ringe poliert
gerade

Double ended ring wrenches

Chrome-Vanadium, CP = chromium plated, polished rings
straight

Clés polygonales

Chrome-Vanadium, CP = chromées, têtes polies
droites

Llaves de estrella planas, de dos bocas

Cromo Vanadio, CP = cromado, cabezas pulidas espejo

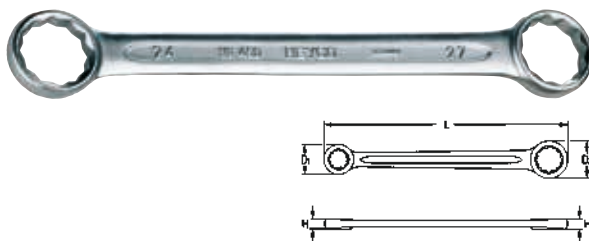

Code	MM	L mm	H mm	D ₁ mm	D ₂ mm	g	g	EAN
00450060782	6 x 7	95	4,2	10,0	11,5	10	10	011753
00450080982	8 x 9	110	4,8	13,0	14,0	15	10	011760
00450101182	10 x 11	120	5,4	16,0	17,0	23	10	011791
00450101382*	10 x 13	138	6,1	16,0	20,0	30	10	011821
00450121382	12 x 13	138	6,1	18,5	20,0	38	10	011838
00450131782	13 x 17	170	7,4	20,0	25,5	55	10	011869
00450141582	14 x 15	155	6,7	21,0	23,0	43	10	011876
00450141782*	14 x 17	170	7,4	21,0	25,5	55	10	011883
00450161782	16 x 17	170	7,4	24,5	25,5	60	10	011890
00450181982	18 x 19	190	8,2	27,0	28,0	85	10	011944
00450202282*	20 x 22	210	8,9	29,5	32,5	115	10	011982
00450212382	21 x 23	232	9,8	30,5	33,5	140	5	011999
00450222482*	22 x 24	232	9,8	32,5	35,5	145	5	012002
00450242782	24 x 27	255	10,7	35,5	39,0	185	5	012019
00450252882	25 x 28	278	11,6	36,5	41,0	220	5	012026
00450303282	30 x 32	305	12,3	43,5	46,0	300	5	012033
00450364182	36 x 41	365	14,3	51,5	59,0	500	5	012040

K 450

Doppelringschlüssel-Sätze

Double ended ring wrench sets

Jeux de clés polygonales

Juegos de llaves de estrella planas, de dos bocas



Code	No.	MM	g	EAN
00450944082	K 450-8-M	6 x 7 8 x 9 10 x 11 12 x 13 14 x 15 16 x 17 18 x 19 20 x 22	390	012057
00450947082	K 450-12-M	6 x 7 8 x 9 10 x 11 12 x 13 14 x 15 16 x 17 18 x 19 20 x 22 21 x 23 24 x 27 25 x 28 30 x 32	1235	012064

475

DIN 838 / ISO 1085



Doppelringschlüssel

Chrom-Vanadium

CP = verchromt, Ringe poliert,
C = verchromt (ab 55 x 60 mm)
tief gekröpft, lange Form

Double ended ring wrenches

Chrome-Vanadium

CP = chromium plated, polished rings
C = chromium plated, (as from 55 x 60 mm)
deep offset, long type

Clés polygonales

Chrome-Vanadium

CP = chromées, têtes polies
C = chromées (de 55 x 60 mm)
contre-coudées profondément, modèle long

Llaves de estrella acodadas, de dos bocas

Cromo Vanadio

CP = cromado, cabezas pulidas espejo
C = cromado (desde 55 x 60 mm)
acodado profundo, modelo largo

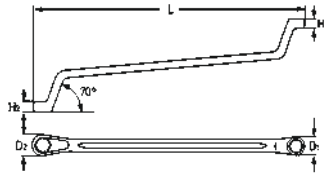
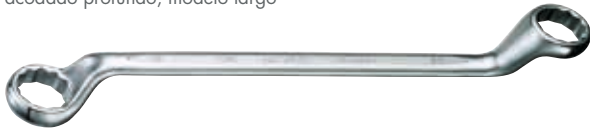

Code	CP	MM	L mm	H ₁ mm	H ₂ mm	D ₁ mm	D ₂ mm	g	g	EAN
00475055782		5,5 x 7	165	5,8	6,3	10,6	12,2	42	10	012194
00475060782		6 x 7	165	5,8	6,3	10,6	12,2	43	10	012200
00475070882		7 x 8	170	6,0	6,7	12,2	13,5	55	10	012217
00475080982		8 x 9	180	6,7	7,3	13,7	15,1	61	10	012224
00475081082		8 x 10	180	6,7	7,5	13,7	16,4	67	10	012231
00475091182		9 x 11	195	7,3	8,1	15,1	17,9	78	10	012248
00475101182		10 x 11	195	7,5	8,1	16,4	17,9	85	10	012255
00475101382		10 x 13	216	7,5	9,0	16,4	20,9	115	10	012279
00475111382		11 x 13	216	8,4	9,0	18,3	20,9	115	10	012286
00475121382		12 x 13	216	8,4	9,0	19,7	20,9	120	10	012293
00475121482		12 x 14	216	8,4	9,3	19,7	22,3	110	10	012309
00475131482		13 x 14	238	9,0	9,3	20,9	22,3	145	10	012316
00475131582		13 x 15	238	9,0	9,3	20,9	24,0	145	10	012323
00475131682		13 x 16	238	9,0	10,2	20,9	25,4	150	10	012330
00475131782		13 x 17	262	9,0	10,4	20,9	27,0	185	5	012347
00475141582		14 x 15	238	9,6	10,1	22,4	25,0	150	10	012354
00475141782		14 x 17	262	9,3	10,4	22,2	27,0	185	5	012361
00475161782		16 x 17	262	10,2	10,4	25,4	27,0	200	5	012378
00475171982		17 x 19	290	10,8	11,0	27,0	29,7	260	5	012415
00475181982		18 x 19	290	10,8	11,0	27,8	29,7	250	5	012422
00475182182		18 x 21	290	11,0	11,8	28,4	32,4	265	5	012439
00475192282		19 x 22	320	11,0	12,2	29,7	34,0	320	5	012453
00475192482		19 x 24	326	11,0	12,8	29,7	37,0	365	5	012477
00475202282		20 x 22	320	11,5	12,2	31,8	34,0	340	5	012484
00475212382		21 x 23	326	11,8	12,5	32,4	35,3	350	5	012491
00475212482		21 x 24	326	11,8	12,8	32,4	37,0	345	5	012507
00475222482		22 x 24	326	12,2	12,8	34,0	37,0	350	5	012521
00475242682		24 x 26	337	12,8	13,9	37,0	41,0	420	5	012538
00475242782		24 x 27	337	12,8	13,9	37,0	41,0	445	5	012552
00475243082		24 x 30	346	12,8	14,6	37,0	45,5	490	5	012569
00475252882		25 x 28	346	13,0	14,2	39,2	43,0	495	5	012576
00475272982		27 x 29	346	13,9	14,6	40,5	45,3	505	5	012583
00475273082		27 x 30	346	13,9	14,6	40,5	45,3	515	5	012590
00475273282		27 x 32	358	13,9	15,5	42,0	49,0	585	5	012606
00475303282		30 x 32	360	14,8	15,5	45,5	49,0	615	5	012620
00475303482		30 x 34	380	14,8	16,5	45,5	51,8	600	5	012637
00475303682		30 x 36	412	16,0	17,6	45,5	53,7	805	5	012644
00475323682		32 x 36	412	17,0	18,2	48,2	53,5	860	5	012651
00475364182		36 x 41	440	18,0	19,5	53,5	60,5	1140	3	012668
00475414682		41 x 46	476	19,7	21,4	63,0	70,0	1300	3	012675
00475465082		46 x 50	500	21,4	22,4	67,0	73,0	1660	1	012682

Code	C	MM	L mm	H ₁ mm	H ₂ mm	D ₁ mm	D ₂ mm	g	g	EAN
00475556080		55 x 60	612	25,0	26,0	86,0	94,0	3935	1	012699
00475657080*		65 x 70	688	27,0	28,0	103,0	110,0	5200	1	012705

Code	CP	AF	L mm	H ₁ mm	H ₂ mm	D ₁ mm	D ₂ mm	g	g	EAN
00475660682		1/4 x 5/16	170	6,0	6,7	12,2	13,5	55	10	012712
00475660982		5/16 x 3/8	180	6,7	7,5	13,7	16,4	64	10	012729
00475661382		3/8 x 7/16	195	7,5	8,1	16,4	17,9	87	10	012736
00475661782		7/16 x 1/2	216	8,4	9,0	18,3	20,9	110	10	012743
00475661982		1/2 x 9/16	239	9,0	9,3	20,9	22,3	145	10	012750
00475662282		9/16 x 5/8	239	9,3	9,7	22,3	25,0	145	10	012767
00475662782		5/8 x 11/16	262	10,2	10,4	25,4	27,0	190	5	012774
00475662882		5/8 x 3/4	290	10,2	11,0	25,4	29,7	230	5	012781
00475663082		11/16 x 3/4	290	10,8	11,0	27,8	29,7	265	5	012798
00475663582		3/4 x 25/32	290	11,0	11,4	29,7	31,8	260	5	012804
00475663782		3/4 x 7/8	320	11,0	12,2	29,7	34,0	305	5	012811
00475664182		13/16 x 7/8	320	11,5	12,2	31,8	34,0	315	5	012828
00475664382		7/8 x 15/16	326	12,2	12,8	34,0	37,0	350	5	012835
00475664682		15/16 x 1	337	12,8	13,9	37,0	41,0	445	5	012842
00475665082		1 x 1.1/8	346	13,0	14,2	39,2	43,0	500	5	012859
00475665382		1.1/16 x 1.1/4	358	13,9	15,5	42,0	49,0	600	5	012866
00475665582*		1.1/8 x 1.5/16	360	14,6	15,5	45,5	50,0	585	5	012873
00475665882*		1.3/16 x 1.5/16	360	14,6	15,5	45,5	50,0	590	5	012880
00475666082*		1.1/4 x 1.3/8	412	17,0	18,2	48,2	53,5	840	5	012897
00475666882*		1.7/16 x 1.5/8	440	18,0	19,5	53,5	60,5	1030	3	012910
00475667482*		1.11/16 x 1.7/8	476	19,7	21,4	63,0	70,0	1260	3	012927
00475667782*		1.13/16 x 2	500	21,4	22,4	67,0	73,0	1570	1	012934

K 475

Doppelringschlüssel-Sätze

Double ended ring wrench sets

Jeux de clés polygonales

Juegos de llaves de estrella planas, de dos bocas

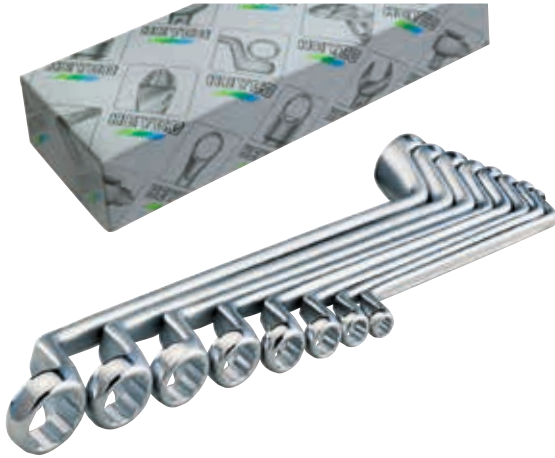

Code	No.	MM	g	EAN		
00475942082	K 475-6-M-1	6 x 7 14 x 15	8 x 9 16 x 17	10 x 11 12 x 13	660	013122
00475942182	K 475-6-M-2	8 x 9 16 x 17	10 x 11 18 x 19	12 x 13 14 x 15	865	013139
00475944082	K 475-8-M	6 x 7 14 x 15	8 x 9 16 x 17	10 x 11 18 x 19	1250	013160
00475947082	K 475-12-M	6 x 7 14 x 15 21 x 23	8 x 9 16 x 17 24 x 27	10 x 11 12 x 13 25 x 28	3155	013184
00475948582	K 475-14-M	6 x 7 14 x 15 21 x 23 36 x 41	8 x 9 16 x 17 24 x 27 46 x 50	10 x 11 12 x 13 25 x 28 30 x 32	5955	013207

Code	No.	AF	g	EAN	
00475962082	K 475-6-AF-1	1/4 x 5/16 1/2 x 9/16 3/4 x 25/32	3/8 x 7/16 5/8 x 11/16 13/16 x 7/8	1050	013214
00475962182	K 475-6-AF-2	3/8 x 7/16 5/8 x 11/16 13/16 x 7/8	1/2 x 9/16 3/4 x 25/32 15/16 x 1	1445	013221
00475964082	K 475-8-AF	1/4 x 5/16 1/2 x 9/16 3/4 x 25/32 15/16 x 1	3/8 x 7/16 5/8 x 11/16 13/16 x 7/8 1.1/16 x 1.1/4	2100	013238
00475967082	K 475-12-AF	1/4 x 5/16 1/2 x 9/16 5/8 x 3/4 3/4 x 7/8 7/8 x 15/16 1 x 1.1/8	3/8 x 7/16 5/8 x 11/16 3/4 x 25/32 13/16 x 7/8 15/16 x 1 1.1/16 x 1.1/4	3485	013245

HP 475-8

Doppelringschlüssel-Satz

im Kunststoffhalter

Double ended ring wrench set

in plastic holder

Jeux de clés polygonales

sur présentoir-support en plastique

Juegos de llaves de estrella planas, de dos bocas

en clip de plástico



Code	No.	MM	g	EAN		
00475644082	HP 475-8-M	6 x 7 14 x 15	8 x 9 16 x 17	10 x 11 12 x 13 18 x 19 20 x 22	1400	423235

R 475

Doppelringschlüssel-Sätze

in Kunststoff-Rolltaschen mit Riemen

Double ended ring wrench sets

in plastic wallets, with strap

Jeux de clés polygonales

en trousse plastique, avec lanière

Juegos de llaves de estrella planas, de dos bocas

en bolsas de plástico, con correa



Code	No.	MM	g	EAN		
00475744082	R 475-8-M	6 x 7 14 x 15	8 x 9 16 x 17	10 x 11 12 x 13 18 x 19 20 x 22	1375	013085
00475747082	R 475-12-M	6 x 7 14 x 15 21 x 23	8 x 9 16 x 17 24 x 27	10 x 11 12 x 13 25 x 28 30 x 32	3320	013092
00475747182	R 475-12-M-1	6 x 7 14 x 15 21 x 23	8 x 9 16 x 17 24 x 26	10 x 11 12 x 13 25 x 28 30 x 32	3310	163728

Code	No.	AF	g	EAN	
00475767082	R 475-12-AF	1/4 x 5/16 1/2 x 9/16 5/8 x 3/4 3/4 x 7/8 7/8 x 15/16 1 x 1.1/8	3/8 x 7/16 5/8 x 11/16 3/4 x 25/32 13/16 x 7/8 15/16 x 1 1.1/16 x 1.1/4	3650	013115

493

Doppel-Gelenksteckschlüssel

Verbesserte Ausführung mit Nietstiften Chrom-Vanadium
CP = verchromt, Köpfe poliert

Double ended swivel wrenches

Improved pattern, with rivet pin
Chrome-Vanadium, CP = chromium plated, polished heads

Clés à douilles articulées

Exécution améliorée, avec axe riveté Chrome-Vanadium
CP = chromées, douilles polies

Llaves de vaso articuladas, de dos bocas

Modelo mejorado, con remaches Cromo Vanadio
CP = cromado, vasos pulidos espejo



- 6 x 7 mm
- 8 x 9 – 21 x 23 mm
- AF 3/8 x 7/16 – 3/4 x 7/8

Code	MM	←L→ mm	D ₁ mm	D ₂ mm	g	g	EAN
00493080982*	8 x 9	186	12,0	13,5	68	10	013429
00493101182*	10 x 11	199	14,5	16,0	100	10	013443
00493141582*	14 x 15	229	20,0	21,5	210	10	013504
00493161782*	16 x 17	246	22,5	24,0	275	10	013528
00493181982*	18 x 19	265	25,0	26,5	350	5	013566

Code	AF	←L→ mm	D ₁ mm	D ₂ mm	g	g	EAN
00493661382*	3/8 x 7/16	199	14,5	16,0	100	10	013634
00493661982*	1/2 x 9/16	229	20,0	21,5	210	10	013658
00493662782*	5/8 x 11/16	246	22,5	24,0	275	10	013672
00493663782*	3/4 x 7/8	285	28,0	30,5	490	5	013719

495

Öldienstschlüssel

Chrom-Vanadium, C = verchromt

9 ■ für Innenvierkant-Schrauben / 1 ■ für Ölfaß-Schlitzschrauben

Drain plug wrenches

Chrome-Vanadium, C = chromium plated

9 ■ for hollow square screws / 1 ■ for slotted oil barrel plugs

Clés de vidange d'huile

Chrome-Vanadium, C = chromées

9 ■ pour vis à carré femelle / 1 ■ pour vis à tête fendue

Llaves para cárter

Cromo Vanadio, C = cromado

9 ■ para tornillos de cárter / 1 ■ para tornillos de barril de aceite



Code	←L→ mm	g	g	EAN
00495000080*	220	440	5	013771

497

DIN 3118

Offene Doppelringschlüssel

Chrom-Vanadium, C = verchromt

für Überwurfmutter an Rohrleitungs-Verschraubungen

8 x 10 – 13 x 14 mm, Köpfe 30° geschlitzt, 15° abgewinkelt

14 x 17 – 30 x 32 mm, Köpfe 15° geschlitzt, 15° abgewinkelt



Flare nut ring wrenches

Chrome-Vanadium, C = chromium plated

for caps and union nuts on pipe fittings

8 x 10 – 13 x 14 mm, rings with gap at 30°, angled at 15°

14 x 17 – 30 x 32 mm, rings with gap at 15°, angled at 15°



Clés à tuyauter

Chrome-Vanadium, C = chromées

pour écrous et vis à chapeau, pour fixation de raccords de tuyaux

8 x 10 – 13 x 14 mm, têtes fendues à 30°, coudées 15°

14 x 17 – 30 x 32 mm, têtes fendues à 15°, coudées 15°



Llaves de estrella abierta, de dos bocas

Cromo Vanadio, C = cromado

para tuercas y tornillos de racores

8 x 10 – 13 x 14 mm,

cabezas con abertura de 30°, inclinadas a 15°

14 x 17 – 30 x 32 mm,

cabezas con abertura de 15°, inclinadas a 15°

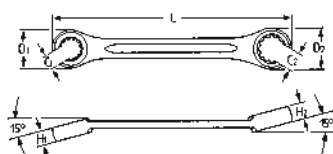

Code	C	MM	←L→ mm	H ₁ mm	H ₂ mm	D ₁ mm	D ₂ mm	C ₁ mm	C ₂ mm	g	g	EAN
00497081080		8 x 10	140	7,0	8,5	18,0	20,0	6,0	7,0	50	10	013801
00497091180		9 x 11	150	8,5	9,0	20,0	22,0	6,5	8,5	60	10	013818
00497101180		10 x 11	150	8,5	9,0	20,0	22,0	7,0	8,5	60	10	013825
00497111380		11 x 13	175	10,0	11,0	26,0	28,0	8,5	10,0	120	10	387322
00497121480		12 x 14	170	9,0	11,0	25,0	28,0	9,0	11,0	95	10	013849
00497131580		13 x 15	175	10,0	11,0	26,0	28,0	10,0	12,0	120	10	387339
00497141780●		14 x 17	200	11,0	12,0	28,0	30,0	11,0	14,0	140	5	013863
00497171980●		17 x 19	210	12,0	14,0	30,0	32,0	14,0	15,0	150	5	013870
00497192280●		19 x 22	220	14,0	16,0	32,0	38,0	15,0	17,0	205	5	013894
00497222480●		22 x 24	235	16,0	17,0	38,0	42,0	17,0	18,0	275	5	013900
00497242780●		24 x 27	255	17,0	18,0	42,0	46,0	18,0	20,0	315	5	013917
00497303280●		30 x 32	280	21,0	23,0	50,0	52,0	21,0	24,0	435	5	013924

800

DIN 1810 A

Hakenschlüssel mit Nase

B = brüniert
für Nutmuttern DIN 1804

Hook wrenches

B = gun-metal-finish
for slotted round nuts DIN 1804

Clés à ergots

B = brunies
pour écrous à encoches DIN 1804

Llaves de gancho con uña

B = pavonado
para tuercas con muesca según DIN 1804

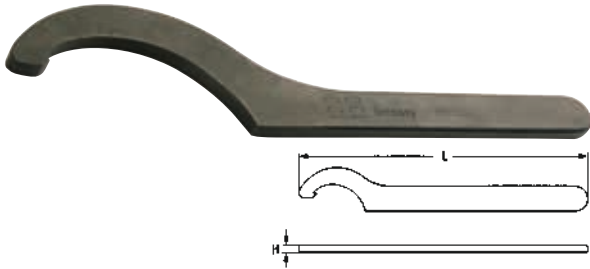

Code	MM	←L→ mm	H mm	g		EAN
00800001230	12/14	110	3,0	25	10	016321
00800001630	16/20	110	3,0	25	10	016338
00800002530	25/28	136	4,0	45	10	016345
00800003030	30/32	136	4,0	50	10	016352
00800003430	34/36	170	5,0	90	10	016369
00800004030	40/42	170	5,0	90	10	016376
00800004530	45/50	206	6,0	155	10	016383
00800005230	52/55	206	6,0	160	10	016390
00800005830	58/62	242	7,0	255	10	016406
00800006830	68/75	242	7,0	255	10	016413
00800008030	80/90	280	8,0	410	5	016420
00800009530	95/100	280	8,0	385	5	016437
00800011030	110/115	335	10,0	745	5	016444
00800012030	120/130	335	10,0	720	5	016451
00800013530	135/145	385	10,0	1000	5	016468
00800015530	155/165	385	10,0	965	5	016475
00800018030	180/195	470	10,0	1580	5	016482
00800020530	205/220	470	10,0	1580	5	016499
00800023030	230/245	560	10,0	2250	1	016505

808

DIN 3111 / ISO 3318

Eintringschlüssel

geölt, gerade

Single ended ring wrenches

oiled, straight

Clés polygonales simples

huilé, droit

Llaves de estrella, de una boca

aceitado, recto

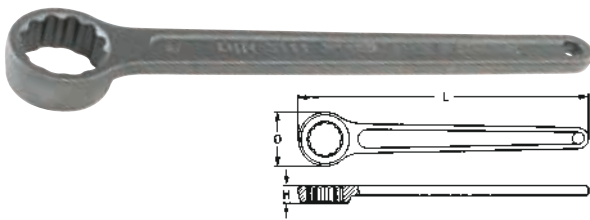

Code	MM	←L→ mm	D mm	H mm	g		EAN
00808001320	13	138	25,0	8,3	60	10	016727
00808001420	14	138	25,0	8,3	60	10	016734
00808001720	17	155	31,0	9,5	100	10	016741
00808001920	19	171	30,0	11,5	120	10	016758
00808002220	22	190	36,0	13,0	150	10	016765
00808002420	24	215	38,0	15,0	205	10	016772
00808002720	27	230	41,5	16,0	240	10	016789
00808003020	30	254	46,0	18,0	320	10	016796
00808003220	32	265	49,0	19,0	350	10	016802
00808003620	36	295	55,0	22,0	500	5	016819
00808004120	41	330	63,0	25,0	780	5	016826
00808004620	46	365	70,5	27,0	950	3	016833
00808005020	50	400	77,0	28,0	1240	3	016840
00808005520	55	442	83,5	29,5	1610	3	016857
00808006520	65	510	97,0	32,0	2210	1	016871

810

DIN 133

Schlag-Maulschlüssel

geölt
Andere Größen auf Anfrage

Slogging open jaw wrenches

oiled
Other sizes on request

Clés à fourche à frapper

huilé
D'autres dimensions sur demande

Llaves de golpe, de una boca abierta

aceitado
Otros tamaños sobre pedido

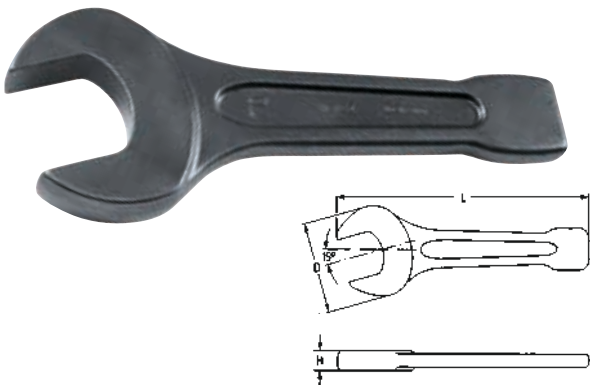

Code	MM	←L→ mm	H mm	D mm	g		EAN
00810002220	22	180	16,0	56	300	5	349023
00810002420	24	180	16,0	56	320	5	016949
00810002720	27	180	16,0	56	310	5	016956
00810003020	30	190	17,0	62	415	5	016963
00810003220	32	190	17,0	62	415	5	016970
00810003620	36	215	17,5	76	640	5	016987
00810003820	38	215	17,5	76	620	5	016994
00810004120	41	235	18,5	86	900	5	017007
00810004620	46	255	20,0	98	1400	3	017014
00810005020	50	275	21,0	105	1600	3	017021
00810005520	55	300	23,0	116	2100	3	017038
00810006020	60	320	24,5	128	2600	1	017045
00810006520	65	342	27,0	138	3400	1	017052
00810007020	70	375	30,0	154	4200	1	017069
00810007520	75	375	30,0	154	4100	1	017076
00810008020	80	408	34,0	174	6200	1	017083
00810008520	85	408	34,0	174	6100	1	017090
00810009020	90	445	38,0	194	7900	1	017106
00810009520	95	445	38,0	194	7700	1	017113
00810010020	100	485	44,0	215	11200	1	017120
00810010520	105	485	44,0	215	10800	1	017137
00810011020	110	510	47,0	235	13100	1	017144
00810011520	115	510	47,0	235	12700	1	017151
00810012020	120	545	50,0	255	17700	1	017168
00810012520	125	545	50,0	255	17400	1	017175
00810013020	130	575	55,0	275	19100	1	017182
00810013520	135	575	55,0	275	18700	1	017199
00810014020	140	575	55,0	275	18300	1	017205
00810014520	145	640	60,0	305	28500	1	017212

810

DIN 133

Schlag-Maulschlüssel

geölt
Andere Größen auf Anfrage

Slogging open jaw wrenches

oiled
Other sizes on request

Clés à fourche à frapper

huilé
D'autres dimensions sur demande

Llaves de golpe, de una boca abierta

aceitado
Otros tamaños sobre pedido

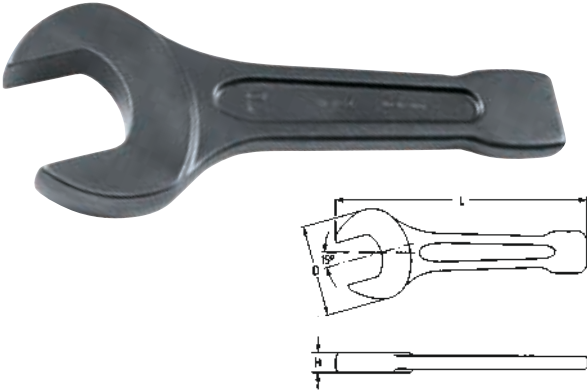

Code	MM	←L→ mm	H mm	D mm	g		EAN
00810015020	150	640	60,0	305	28000	1	017229
00810015520	155	640	60,0	305	27500	1	017236
00810016020	160	640	60,0	305	27000	1	017243
00810016520	165	715	70,0	342	42000	1	017250
00810017020	170	715	70,0	342	41000	1	017267
00810017520	175	715	70,0	342	40000	1	017274
00810018020	180	715	70,0	342	39000	1	017281
00810018520	185	715	70,0	342	38000	1	017298
00810019020	190	800	78,0	392	56000	1	017304
00810019520	195	800	78,0	392	55000	1	017311
00810020020	200	800	78,0	392	53000	1	017328
00810021020	210	800	78,0	392	51000	1	017335
00810022020	220	800	72,0	415	49000	1	017342
00810023020	230	800	72,0	415	47000	1	017359

Code	AF	←L→ mm	H mm	D mm	g		EAN
00810633420	7/8	180	16,0	56	320	5	017366
00810633720	1	180	16,0	56	310	5	017373
00810633820	1.1/16	180	16,0	56	310	5	017380
00810633920	1.1/8	180	16,0	56	305	5	017397
00810634020	1.3/16	190	17,0	62	450	5	017403
00810634120	1.1/4	190	17,0	62	415	5	017410
00810634220	1.5/16	190	17,0	62	405	5	017427
00810634320	1.3/8	215	17,5	76	650	5	017434
00810634420	1.7/16	215	17,5	76	640	5	017441
00810634520	1.1/2	215	17,5	76	630	5	017458
00810634620	1.9/16	235	18,5	86	910	5	017465
00810634720	1.5/8	235	18,5	86	900	5	017472
00810634820	1.11/16	235	18,5	86	890	5	017489
00810634920	1.3/4	235	18,5	86	870	5	017496
00810635020	1.13/16	255	20,0	98	1400	3	017502
00810635120	1.7/8	255	20,0	98	1390	3	017519
00810638020	1.15/16	275	21,0	105	1590	3	017809
00810635220	2	275	21,0	105	1600	3	017526
00810635320	2.1/16	275	21,0	105	1550	3	017533
00810635420	2.1/8	275	21,0	105	1500	3	017540
00810635520	2.3/16	300	23,0	116	2100	3	017557
00810635620	2.1/4	300	23,0	116	2050	3	017564
00810635720	2.5/16	300	23,0	116	2000	3	017571
00810635820	2.3/8	320	24,5	128	2600	1	017588
00810635920	2.7/16	320	24,5	128	2550	1	017595
00810636020	2.1/2	320	24,5	128	2500	1	017601
00810636120	2.9/16	342	27,0	138	3400	1	017618
00810636220	2.5/8	342	27,0	138	3350	1	017625
00810639520	2.11/16	375	30,0	154	4250	1	017878
00810636320	2.3/4	375	30,0	154	4200	1	017632
00810636420	2.13/16	375	30,0	154	4150	1	017649
00810638320	2.7/8	375	30,0	154	4100	1	017830
00810636520	2.15/16	375	30,0	154	4100	1	017656
00810636620	3	375	30,0	154	4050	1	017663
00810636720	3.1/8	408	34,0	174	6250	1	017670
00810636820	3.1/4	408	34,0	174	6150	1	017687
00810636920	3.3/8	408	34,0	174	6050	1	017694
00810637020	3.1/2	445	38,0	194	7950	1	017700
00810637120	3.5/8	445	38,0	194	7850	1	017717
00810637220	3.3/4	445	38,0	194	7700	1	017724
00810637320	3.7/8	485	44,0	215	11250	1	017731
00810637420	4	485	44,0	215	11150	1	017748
00810637520	4.1/8	485	44,0	215	10800	1	017755
00810637620	4.1/4	510	47,0	235	13200	1	017762
00810639620	4.3/8	510	47,0	235	13000	1	017885
00810637720	4.1/2	510	47,0	235	12700	1	017779
00810637820	4.5/8	510	47,0	235	12650	1	017786
00810638120	4.3/4	545	50,0	255	17700	1	017816
00810639720	4.7/8	545	50,0	255	17450	1	017892
00810638220	5	545	50,0	255	17400	1	017823
00810637920	5.1/4	575	55,0	275	18750	1	017793
00810638620	5.1/2	575	55,0	275	18300	1	017847
00810638720	5.5/8	640	60,0	305	28400	1	017854
00810639020	6	640	60,0	305	27900	1	017861

820

DIN 7444



Schlag-Ringschlüssel

geölt
Andere Größen auf Anfrage

Slogging ring wrenches

oiled
Other sizes on request

Clés polygonales à frapper

huilé
D'autres dimensions sur demande

Llaves de golpe, de una boca estrella

aceitado
Otros tamaños sobre pedido

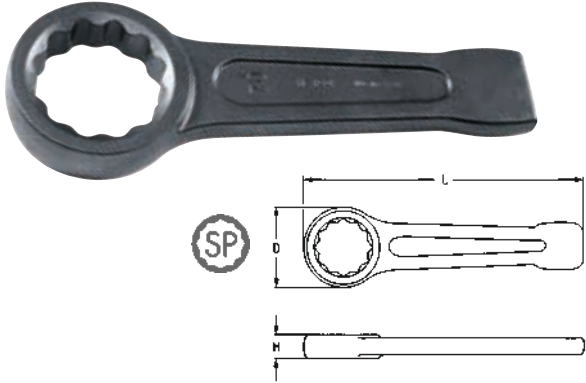

Code	MM	←L→ mm	H mm	D mm	g		EAN
00820002420	24	165	15,0	43	260	5	018028
00820002720	27	180	16,0	46	280	5	018035
00820003020	30	190	17,0	52	420	5	018042
00820003220	32	190	17,0	52	400	5	018059
00820003620	36	205	18,0	58	540	5	018066
00820003820	38	205	19,0	59	530	5	018073
00820004120	41	230	20,0	66	700	5	018080
00820004620	46	240	22,0	74	900	3	018097
00820005020	50	255	24,0	80	1150	3	018103
00820005520	55	270	25,0	86	1380	3	018110
00820006020	60	280	26,0	93	1540	1	018127
00820006520	65	300	30,0	102	2100	1	018134
00820007020	70	330	33,0	110	2850	1	018141
00820007520	75	330	33,0	110	2700	1	018158
00820008020	80	360	36,0	126	3900	1	018165
00820008520	85	360	36,0	126	3700	1	018172
00820009020	90	390	40,0	142	5150	1	018189
00820009520	95	390	40,0	142	4900	1	018196
00820010020	100	420	45,0	155	6450	1	018202
00820010520	105	420	45,0	155	6200	1	018219
00820011020	110	450	48,0	170	8000	1	018226
00820011520	115	450	48,0	170	7750	1	018233
00820012020	120	480	54,0	182	9500	1	018240
00820012520	125	480	54,0	182	9250	1	018257
00820013020	130	520	58,0	202	13200	1	018264
00820013520	135	520	58,0	202	12800	1	018271
00820014020	140	520	58,0	210	12500	1	018288
00820014520	145	580	64,0	228	18800	1	018295
00820015020	150	580	64,0	228	18500	1	018301
00820015520	155	580	64,0	228	18200	1	018318
00820016020	160	580	64,0	240	17800	1	018325
00820016520	165	650	70,0	265	28600	1	018332
00820017020	170	650	70,0	265	28000	1	018349
00820017520	175	650	70,0	265	27400	1	018356
00820018020	180	650	70,0	265	27000	1	018363
00820018520	185	700	75,0	290	34000	1	018370
00820019020	190	700	75,0	290	33000	1	018387
00820019520	195	700	75,0	290	32000	1	018394
00820020020	200	700	75,0	290	31000	1	018400
00820021020	210	750	80,0	320	39000	1	018417
00820022020	220	750	80,0	320	37000	1	018424
00820023020	230	750	80,0	320	35000	1	018431

Code	AF	←L→ mm	H mm	D mm	g		EAN
00820633420	7/8	165	15,0	43	240	5	018448
00820633720	1	165	15,0	43	250	5	018462
00820633820	1.1/16	180	16,0	46	280	5	018479
00820633920	1.1/8	180	16,0	46	275	5	018486
00820634020	1.3/16	190	17,0	52	420	5	018493
00820634120	1.1/4	190	17,0	52	400	5	018509
00820634220	1.5/16	190	17,0	52	390	5	018516
00820634320	1.3/8	205	18,0	58	550	5	018523
00820634420	1.7/16	205	18,0	58	540	5	018530
00820634520	1.1/2	205	18,0	58	530	5	018547
00820634620	1.9/16	230	20,0	66	710	5	018554
00820634720	1.5/8	230	20,0	66	700	5	018561
00820634820	1.11/16	230	20,0	66	690	5	018578
00820634920	1.3/4	240	22,0	74	910	3	018585
00820635020	1.13/16	240	22,0	74	900	3	018592
00820635120	1.7/8	240	22,0	74	890	3	018608
00820638020	1.15/16	255	24,0	80	1160	3	018899
00820635220	2	255	24,0	80	1140	3	018615
00820635320	2.1/16	255	24,0	80	1130	3	018622
00820635420	2.1/8	270	25,0	86	1390	3	018639
00820635520	2.3/16	270	25,0	86	1375	3	018646
00820635620	2.1/4	270	25,0	86	1370	3	018653
00820635720	2.5/16	280	26,0	93	1550	1	018660
00820635820	2.3/8	280	26,0	93	1540	1	018677
00820635920	2.7/16	280	26,0	93	1530	1	018684
00820636020	2.1/2	280	26,0	93	1520	1	018691
00820636120	2.9/16	300	30,0	102	2100	1	018707

820

DIN 7444



Schlag-Ringschlüssel

geölt
Andere Größen auf Anfrage

Slogging ring wrenches

oiled
Other sizes on request

Clés polygonales à frapper

huilé
D'autres dimensions sur demande

Llaves de golpe, de una boca estrella

aceitado
Otros tamaños sobre pedido

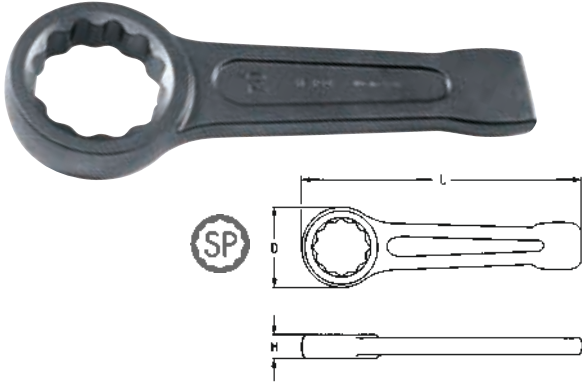

Code	AF	←L→ mm	H mm	D mm	g		EAN
00820636220	2.5/8	300	30,0	102	2080	1	018714
00820639520	2.11/16	300	30,0	102	2050	1	019001
00820636320	2.3/4	330	33,0	110	2850	1	018721
00820636420	2.13/16	330	33,0	110	2820	1	018738
00820638320	2.7/8	330	33,0	110	2800	1	018929
00820636520	2.15/16	330	33,0	110	2700	1	018745
00820636620	3	330	33,0	110	2680	1	018752
00820636720	3.1/8	360	36,0	126	3910	1	018769
00820636820	3.1/4	360	36,0	126	3890	1	018776
00820636920	3.3/8	360	36,0	126	3690	1	018783
00820637020	3.1/2	390	40,0	142	5170	1	018790
00820637120	3.5/8	390	40,0	142	5130	1	018806
00820637220	3.3/4	390	40,0	142	4900	1	018813
00820637320	3.7/8	420	45,0	155	6480	1	018820
00820637420	4	420	45,0	155	6430	1	018837
00820637520	4.1/8	420	45,0	155	6200	1	018844
00820637620	4.1/4	450	48,0	170	8050	1	018851
00820639620	4.3/8	450	48,0	170	7980	1	019018
00820637720	4.1/2	450	48,0	170	7780	1	018868
00820637820	4.5/8	450	48,0	170	7750	1	018875
00820638120	4.3/4	480	54,0	182	9500	1	018905
00820639720	4.7/8	480	54,0	182	9220	1	019025
00820638220	5	480	54,0	182	9200	1	018912
00820638420	5.1/8	520	58,0	202	13200	1	018936
00820637920	5.1/4	520	58,0	202	12830	1	018882
00820638520	5.3/8	520	58,0	202	12790	1	018943
00820638620	5.1/2	520	58,0	210	12950	1	018950
00820638720	5.5/8	580	64,0	228	18850	1	018967
00820638820	5.3/4	580	64,0	228	18780	1	018974
00820638920	5.7/8	580	64,0	228	18520	1	018981
00820639020	6	580	64,0	228	18450	1	018998

840

Zug-Ringschlüssel

Chrom-Vanadium, C = verchromt,
schwere Ausführung, gekröpft, zu verwenden mit Aufsteckrohr
HEYCO 845. Andere Größen auf Anfrage.

Single ended ring wrenches

Chrome-Vanadium, C = chromium plated,
heavy duty pattern, offset, to be used with tubular handles HEYCO 845.
Other sizes on request.

Clés polygonales contre-coudées gros effort

Chrome-Vanadium, C = chromées,
modèle lourd, coudées, à utiliser avec rallonge HEYCO 845.
D'autres dimensions sur demande.

Llave de estrella acodada, de una boca

Cromo Vanadio, C = cromado,
modelo pesado, acodado, para usar con mango tubular HEYCO 845.
Otros tamaños sobre pedido.



Code	MM	←L→ mm	H mm	D ₁ mm	D ₂ mm	für/for	g		EAN
00840002280	22	180	17,0	38		845-0	440	5	019209
00840002480	24	180	17,0	38	18,5	845-0	420	5	019216
00840002780	27	190	17,0	41		845-0	450	5	019223
00840003080	30	200	18,0	48		845-0	520	5	019230
00840003280	32	235	18,0	49		845-1	750	5	019247
00840003680	36	245	20,0	54	21,5	845-1	840	5	019254
00840004180	41	265	22,0	62		845-1	1000	5	019261
00840004680	46	280	23,0	69		845-2	1200	3	019278
00840005080	50	290	25,5	76	24,5	845-2	1400	3	019285
00840005580	55	300	28,0	81		845-2	1500	3	019292
00840006080	60	345	30,5	90		845-3	2300	1	019308
00840006580	65	355	33,0	98		845-3	2700	1	019315
00840007080	70	365	35,5	105		845-3	2800	1	019322
00840007580	75	375	38,0	110		845-3	3100	1	019339
00840008080	80	385	40,5	125	29,5	845-3	3800	1	019346
00840008580	85	385	40,5	125		845-3	3600	1	019353
00840009080	90	410	45,0	140		845-3	5100	1	019360
00840009580	95	410	45,0	140		845-3	4800	1	019377
00840010080	100	412	45,0	143		845-3	4900	1	019384

845

Aufsteckrohre

Z = verzinkt, für Zug-Ringschlüssel HEYCO 840

Tubular handles

Z = zinc plated, for single ended ring wrenches HEYCO 840

Rallonges

Z = galvanisé, bleu passivé, pour clés polygonales HEYCO 840

Mangos tubulares

Z = cincado, cromatizado azul, para llaves de estrella acodadas,
de una boca HEYCO 840



Code	No.	für/for HEYCO 840	←L→ mm	Ø innen/inside mm	g		EAN
00845000060	845-0	22-30 mm	460	19	625	5	146349
00845000160	845-1	32-41 mm	610	22	1125	1	146356
00845000260	845-2	46-55 mm	760	25	2150	1	146363
00845000360	845-3	60-100 mm	860	30	2875	1	146370

STECKSCHLÜSSELPROGRAMM

SOCKET PROGRAM

34-41 Seite/page



Antriebs- und Verbindungsteile
Drive and connecting parts
Pièces d'entraînement et de connexion
Accionamiento y piezas de conexión

42-54 Seite/page



Antriebs- und Verbindungsteile
Drive and connecting parts
Pièces d'entraînement et de connexion
Accionamiento y piezas de conexión

55-74 Seite/page



Antriebs- und Verbindungsteile
Drive and connecting parts
Pièces d'entraînement et de connexion
Accionamiento y piezas de conexión

75-77 Seite/page



Antriebs- und Verbindungsteile
Drive and connecting parts
Pièces d'entraînement et de connexion
Accionamiento y piezas de conexión

78-79 Seite/page



Antriebs- und Verbindungsteile
Drive and connecting parts
Pièces d'entraînement et de connexion
Accionamiento y piezas de conexión

80-91 Seite/page

IMPACT

92-95 Seite/page

Drehmomentschlüssel
Torque wrenches
Clés dynamométriques
Llave dinamométrica

96-99 Seite/page

Diverse Schlüssel
Various wrenches
Clés diverses
Varias llaves





VARICAT

PERFEKTION IM DETAIL

- Auslöseknopf sorgt für leichtes Aufstecken und Abziehen der Steckschlüsseleinsätze
- Kugelarretierung sorgt für sicheren Halt während der Anwendung
- Profilierter Schalthebel für Rechts-/ Linkslauf, abrutschsicher
- Kupplungsrad dient zum Eindrehen und Ausdrehen von losen, leichtgängigen Schraubverbindungen
- Kraftvolles Design des Schaftes, ausgelegt für höchste Beanspruchung
- 2-Komponenten-Griff mit besonderer Haptik für ermüdungsfreies Arbeiten
- Aufhängeloch dient der übersichtlichen Aufbewahrung
- Feinverzahnung mit bis zu 72 Zähnen, garantiert einen kleinen Schwenkwinkel
- Modulare Bauweise für einfache Wartung und Pflege

PERFECTION IN DETAIL

- Release button for effortless mounting and removal of the sockets
- Ball stop for reliable locking during operation
- Molded shift lever for clockwise-/ anticlockwise operation, slip proof
- The wheel serves to tighten and turn out loose, easy running nuts and bolts
- Powerful design of the shaft made for highest demands
- 2K-handle with special ergonomics allows fatigue-free working
- Pin hole for a clearly arranged storage
- Fine gearing with up to 72 teeth ensures a small swivel angle
- Modular construction for easy maintenance

LA PERFECTION EN DÉTAIL

- Un bouton de déverrouillage permet l'assemblage ou le retrait facile de la douille de tournevis
- Le verrouillage à bille assure une bonne prise en main lors de l'utilisation
- Levier profilé pour marche avant/ marche arrière, empêche le glissement
- La roulette permet de serrer et desserrer, écrous et boulons faciles à utiliser
- La tige a été conçue pour une charge maximale
- Poignée à 2 composants - ergonomie spéciale pour pouvoir travailler sans fatigue
- Un trou de montage permet un rangement propre et utile
- Une denture fine ayant jusqu'à 72 dents assure un petit angle de pivotement
- Designe modulaire permet un entretien facile

 34-41 Seite/page

 42-54 Seite/page

 55-74 Seite/page



LA PERFECCIÓN DEL DETALLE

- Botón de desenganche para colocar y quitar las llaves de vaso
- Sujeción de bola para dar una sujeción segura
- Palanca perfilada para movimiento a derecha e izquierda, antideslizante
- La rueda de acoplamiento sirve para atornillar y desatornillar, conexiones de tornillos ligeras y flexibles
- Diseño compacto del mango para máximos esfuerzos
- Mango de dos componentes, tacto especial para reducir el cansancio en el trabajo
- Agujero para colgar
- Dentado fino de hasta 72 dientes, para facilitar ángulo de giro pequeños
- Construcción modular para simplificar el mantenimiento y limpieza





ANTRIEBS- UND VERBINDUNGSTEILE

DRIVE AND CONNECTING PARTS

Chrom-Vanadium
C = verchromt
CPP = verchromt, ganz poliert
mit Kugel-Arretierung

Chrome-Vanadium
C = chromium plated
CPP = chromium plated, fully polished
with spring-loaded retaining ball

25-00-15

DIN 3122 D · ISO 3315

VARICAT

Hebelumschaltknarre

Reversible ratchet

Cliquet réversible à levier

Carraca reversible



72 Zähne/teeth/dents/dientes

Code	No.	Ausf. finish	←L→ mm	g		EAN
00025010583	25-00-15	CPP	140	96	1	404272

25-03

DIN 3122 A · ISO 3315

Griff mit Gleitstück

Sliding T-handle

Poignée coulissante

Mango corredizo



Code	No.	Ausf. finish	←L→ mm	g		EAN
00025030083	25-03	CPP	114	40	10	000351

25-04/-05/-05-1

DIN 3123 B · ISO 3316

Verlängerung

Extension bar

Rallonge

Alargadera



Code	No.	Ausf. finish	←L→ mm	g		EAN
00025040083	25-04	CPP	55	24	10	000375
00025050083	25-05	CPP	105	45	10	000382
00025051083	25-05-1	CPP	150	65	10	000399

25-05-5

Schwenkbare Verlängerung

Wobble extension

Rallonge articulée

Alargadera oscilante



Code	No.	Ausf. finish	←L→ mm	g		EAN
00025055083	25-05-5	CPP	100	45	10	112849

25-06

DIN 3123 C · ISO 3316

Kardangelenk

Universal joint

Cardan universel

Articulación universal



Code	No.	Ausf. finish	←L→ mm	g		EAN
00025060083	25-06	CPP	35	23	10	000405



25-07

DIN 3122 F · ISO 3315

Gelenkgriff

Swivel handle

Poignée articulée

Mango articulado



Code	No.	Ausf. finish	←L→ mm	g		EAN
00025070083	25-07	CPP	155	115	10	000412

25-08

DIN 3122 E · ISO 3315

Steckgriff

Spinner handle

Rallonge emmanchée

Mango recto



Code	No.	Ausf. finish	←L→ mm	g		EAN
00025080083	25-08	CPP	145	60	10	000429

25-11

DIN 3123 B · ISO 3316

Biegsame Verlängerung

Flexible extension

Rallonge flexible

Alargadera flexible



Code	No.	Ausf. finish	←L→ mm	g		EAN
00025110080	25-11	C	120	50	10	113846

25-15 6101-30

Verbindungsstück

Converter

Augmentateur

Amplificador



DIN 3123 A · ISO 3316

Code	No.	Ausf. finish	←L→ mm	g		EAN
00025150083	25-15	CPP	27	17	10	000559
06101003080	6101-30	C	25	20	10	118452

25-6

DIN 3124 / ISO 2725

Steckschlüssel-Einsätze

Chrom-Vanadium

CPP = verchromt, ganz poliert mit Kugelfangrinne

Sockets

Chrome-Vanadium

CPP = chromium plated, fully polished, with ball retaining groove

Douilles

Chrome-Vanadium

CPP = chromées, entièrement polies avec gorge de verrouillage pour bille

Llaves de vaso

Cromo Vanadio

CPP = cromado, cabeza pulida espejo con ranura de retención por bola

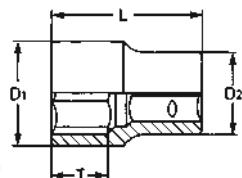

Code	MM	←L→ mm	D ₁ mm	D ₂ mm	T mm	g		EAN
00025000483	4	25	6,8	11,8	6,5	9	10	000177
00025004583	4,5	25	7,3	11,8	7,5	9	10	000283
00025000583	5	25	7,9	11,8	7,5	10	10	000184
00025005583	5,5	25	8,5	11,8	8,0	10	10	000290
00025000683	6	25	9,2	11,8	8,0	10	10	000191
00025000783	7	25	10,5	11,8	8,0	11	10	000207
00025000883	8	25	11,8	11,8	8,0	11	10	000214
00025000983	9	25	13,4	12,0	8,0	13	10	000221
00025001083	10	25	14,0	12,0	8,0	13	10	000238
00025001183	11	25	15,8	12,5	10,0	15	10	000245
00025001283	12	25	17,2	13,5	10,0	18	10	000252
00025001383	13	25	18,0	13,5	11,0	18	10	000269
00025001483	14	25	19,5	14,5	12,0	22	10	000276



25-6

DIN 3124 / ISO 2725



Steckschlüssel-Einsätze

Chrom-Vanadium
CPP = verchromt, ganz poliert
mit Kugelfangrinne

Sockets

Chrome-Vanadium
CPP = chromium plated, fully polished, with ball retaining groove

Douilles

Chrom-Vanadium
CPP = chromées, entièrement polies
avec gorge de verrouillage pour bille

Llaves de vaso

Cromo Vanadio
CPP = cromado, cabeza pulida espejo
con ranura de retención por bola

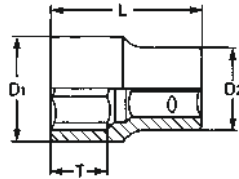

Code	AF	←L→ mm	D ₁ mm	D ₂ mm	T mm	g		EAN
00025630583	1/8	25	6,4	11,8	4,0	9	10	001020
00025630783	5/32	25	6,8	11,8	6,5	9	10	001037
00025630883	3/16	25	7,8	11,8	7,5	10	10	001044
00025631083	7/32	25	8,7	11,8	8,0	10	10	001051
00025631283	1/4	25	9,8	11,8	8,0	10	10	001068
00025631483	9/32	25	10,7	11,8	8,0	11	10	001075
00025631683	5/16	25	11,8	11,8	8,0	11	10	001082
00025631883	11/32	25	13,4	12,0	8,0	13	10	001099
00025631983	3/8	25	14,0	12,0	8,0	13	10	001105
00025632183	7/16	25	15,8	12,5	10,0	15	10	001112
00025632383	1/2	25	18,0	13,5	11,0	19	10	001129
00025632583	9/16	25	19,5	14,5	12,0	22	10	001136

25-19

DIN 3124 / ISO 2725



Steckschlüssel-Einsätze, extra lang

Chrom-Vanadium
CPP = verchromt, ganz poliert
mit Kugelfangrinne

Sockets, extra deep

Chrome-Vanadium
CPP = chromium plated, fully polished, with ball retaining groove

Douilles, extra longues

Chrom-Vanadium
CPP = chromées, entièrement polies
avec gorge de verrouillage pour bille

Llaves de vaso, extra largo

Cromo Vanadio
CPP = cromado, cabeza pulida espejo
con ranura de retención por bola



Code	MM	←L→ mm	D ₁ mm	D ₂ mm	T mm	g		EAN
00025190483	4	50	6,8	11,8	11,8	17	10	365146
00025194583	4,5	50	7,0	11,8	15,3	19	10	365153
00025190583	5	50	7,8	11,8	15,8	21	10	365160
00025195583	5,5	50	8,2	11,8	15,8	21	10	365177
00025190683	6	50	9,2	11,8	17,2	22	10	365184
00025190783	7	50	10,5	11,8	20,7	23	10	365191
00025190883	8	50	11,8	11,8	20,9	25	10	365207
00025190983	9	50	12,9	12,9	21,4	29	10	365214
00025191083	10	50	14,5	14,5	21,4	35	10	365221
00025191183	11	50	15,8	15,8	21,4	42	10	365238
00025191283	12	50	16,8	16,8	25,7	45	10	365245
00025191383	13	50	17,8	17,8	25,4	52	10	365252
00025191483	14	50	19,6	19,6	30,8	52	10	365269

25-20

Steckschlüssel-Einsätze

Chrom-Vanadium, CPP = verchromt, ganz poliert
mit Kugelfangrinne für Außen-TORX®-Schrauben

Sockets

Chrome-Vanadium, CPP = chromium plated, fully polished
with ball retaining groove for TORX®-head screws

Douilles

Chrom-Vanadium, CPP = chromées, entièrement polies
avec gorge de verrouillage pour bille pour vis TORX®-extérieures

Llaves de vaso

Cromo Vanadio, CPP = cromado, cabeza pulida espejo
con ranura de retención por bola para tornillos TORX® exteriores

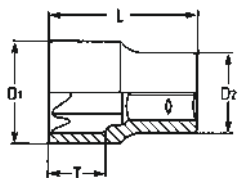

Code	Größe size	mm	←L→ mm	T mm	D ₁ mm	D ₂ mm	g		EAN
00025200483	E 4	3,86	25	5	5,4	12	9	10	000733
00025200583	E 5	4,75	25	5	6,7	12	10	10	000740
00025200683	E 6	5,74	25	5	7,7	12	10	10	000757
00025200783	E 7	6,22	25	6	8,3	12	10	10	000764
00025200883	E 8	7,52	25	7	9,6	12	11	10	000771
00025201083	E 10	9,42	25	8	11,3	12	12	10	000788



25-30 - 25-36

Schraubendreher-Einsätze

Körper: Chrom-Vanadium, CPP = verchromt, ganz poliert mit Kugelfangrinne

Bits: Sonderstahl, PH = phosphatiert

Screwdriver sockets

Socket bodies: Chrome-Vanadium, CPP = chromium plated fully polished, with ball retaining groove

Bits: Special steel, PH = phosphated

Douilles tournevis

Douilles: Chrome-Vanadium, CPP = chromées, entièrement polies avec gorge de verrouillage pour bille

Embouts: Acier Spécial, PH = phosphaté

Llaves de vaso con destornillador

Cuerpo: Cromo Vanadio, CPP = cromado, enteramente pulido espejo, con ranura de retención por bola

Puntas: Acero aleado, PH = fosfatado



25-30



25-31



25-32



25-35



25-36

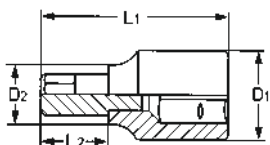

25-30 für Schlitz-Schrauben/for plain slot screws

Code	$\frac{1}{4}$ mm	$\frac{1}{4}$ mm	L ₁ mm	L ₂ mm	D ₁ mm	D ₂ mm	$\frac{1}{g}$		EAN
00025300183	3	0,5	34,5	15	12	11	13	10	000795
00025300283	3,5	0,6	34,5	15	12	11	13	10	000801
00025300383	4	0,8	34,5	15	12	11	13	10	000818
00025300483	5,5	1,0	34,5	15	12	11	14	10	000825
00025300583	6,5	1,2	34,5	15	12	11	15	10	000832
00025300683	8	1,2	34,5	15	12	11	15	10	094343

25-31 für Innensechskant-Schrauben/for hexagon socket screws, DIN 7422/ISO 1174

Code	MM	L ₁ mm	L ₂ mm	D ₁ mm	D ₂ mm	$\frac{1}{g}$		EAN
00025310183	3	34,5	15	12	11	13	10	000849
00025310283	4	34,5	15	12	11	14	10	000856
00025310383	5	34,5	15	12	11	15	10	000863
00025310483	6	34,5	15	12	11	15	10	000870
00025310583	8	34,5	15	12	11	18	10	000887

Code	AF	L ₁ mm	L ₂ mm	D ₁ mm	D ₂ mm	$\frac{1}{g}$		EAN
00025313083	1/8	34,5	15	12	11	13	10	094558
00025313183	5/32	34,5	15	12	11	14	10	094565
00025313283	3/16	34,5	15	12	11	14	10	094572
00025313383	7/32	34,5	15	12	11	15	10	094589
00025313483	1/4	34,5	15	12	11	16	10	094596
00025313683	5/16	34,5	15	12	11	18	10	094602

25-32 für Kreuzschlitz-Schrauben/for cross slot screws PHILLIPS-RECESS

Code	No.	L ₁ mm	L ₂ mm	D ₁ mm	D ₂ mm	$\frac{1}{g}$		EAN
00025320183	1	34,5	15	12	11	13	10	000894
00025320283	2	34,5	15	12	11	14	10	000900
00025320383	3	34,5	15	12	11	15	10	000917
00025320483	4	34,5	15	12	11	17	10	000924

25-35 für Kreuzschlitz-Schrauben/for cross slot screws POZIDRIV®

Code	No.	L ₁ mm	L ₂ mm	D ₁ mm	D ₂ mm	$\frac{1}{g}$		EAN
00025350183	1	34,5	15	12	11	13	10	094473
00025350283	2	34,5	15	12	11	14	10	094480
00025350383	3	34,5	15	12	11	15	10	094497
00025350483	4	34,5	15	12	11	17	10	094503

25-36 für Innen-TORX®-Schrauben/for TORX®-socket screws

Code	Größe size	mm	L ₁ mm	L ₂ mm	D ₁ mm	D ₂ mm	$\frac{1}{g}$		EAN
00025360683	T 6	1,67	34,5	15	12	11	13	10	094527
00025360783	T 7	1,99	34,5	15	12	11	13	10	094510
00025360883	T 8	2,31	34,5	15	12	11	13	10	000931
00025360983	T 9	2,50	34,5	15	12	11	13	10	000948
00025361083	T 10	2,74	34,5	15	12	11	13	10	000955
00025361583	T 15	3,27	34,5	15	12	11	14	10	000962
00025362083	T 20	3,86	34,5	15	12	11	14	10	000979
00025362583	T 25	4,43	34,5	15	12	11	14	10	000986
00025362783	T 27	4,99	34,5	15	12	11	14	10	094534
00025363083	T 30	5,52	34,5	15	12	11	15	10	000993
00025364083	T 40	6,65	34,5	15	12	11	15	10	094541



3301-1

Magnet-Bithalter

zur Aufnahme von Bits mit Außensechskant 1/4", Klinge verchromt, mit 2-K Kunststoffheft

Magnetic bitholder

for bits 1/4"-drive, chromium plated, with 2-K plastic handle

Adaptateur magnétique

pour embots 1/4", couteau chromatisé, avec manche à 2 composants

Soporte imantado para puntas de destornillador

Para acoplamiento de puntas con hexágono exterior de 1/4", hoja cromada, mango de plástico de dos componentes



Code	No.	←L→ mm	g		EAN
03301010080	3301-1	200	102	10	366204

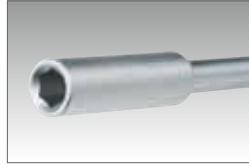

25-70

Steckschlüssel-Einsätze auf Aluminium-Klemmleiste, 13-tlg.

Chrom-Vanadium, CPP = verchromt, ganz poliert. Aluminium-Klemmleiste grün eloxiert, mit Kugelfangrinne.

Sockets on aluminium socket rail, 13 pcs.

Chrome-Vanadium, CPP = chromium plated, fully polished. Aluminium socket rail, anodized, with ball retaining groove.

Assortiment douilles sur bande alu, 13 pcs.

Chrome-Vanadium, CPP = chromées, entièrement polies. Bloc aluminium anodisé, avec gorge de verrouillage pour bille.

Juego de 13 llaves de vaso en regla de sujeción de aluminio

Cromo Vanadio, CPP = cromado, cabeza pulida espejo. Regla de sujeción, de aluminio anodizado color verde, con ranura de retención por bolae.



Code	No.	tlg./pcs.	g		EAN
00025700083	25-70-M	13	465	1	366716

enthaltend/containing

Stck./pcs.	Artikel/article	No.	Maße/dimensions
13		25-6-M	MM 4 4,5 5 5,5 6 7 8 9 10 11 12 13 14

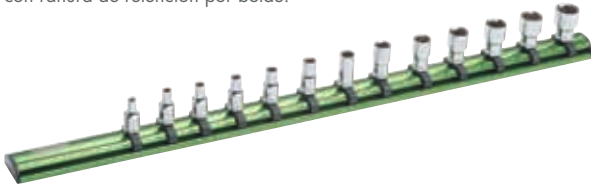

987-25

Aluminium-Klemmleiste, leer

zur Aufnahme von max. 13 Einsätzen. Kugelgefederte Aufnahme gewährleistet perfekten Halt der Einsätze. Sicherer Halt der Klemmleiste durch Magnet an Metallflächen.

Aluminium socket rail, empty

for max. 13 sockets. Spring-loaded retaining ball ensures a perfect hold of the sockets. A strong magnet securely holds the socket rail to ferrous metal.

Bornes en aluminium, vide

pour max. 13 inserts. Les billes à ressort assurent une parfaite prise en main. Blocage des bornes dues aux aimants et les surfaces métalliques.

Regla de aluminio anodizado color verde

para sujeción de 13 llaves de vaso. Sujeción con muelle, garantiza una firme colocación de los vasos. Regla sujeta por imán.



Code	No.	tlg./pcs.	g		EAN
98710251600	987-25	1	253	1	365276

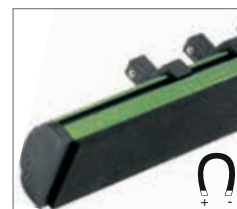
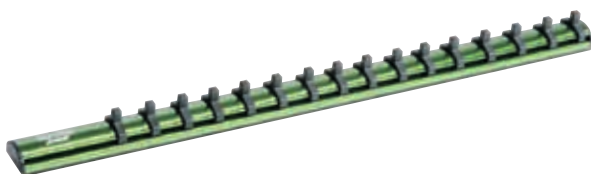



25-50

Satz mit Schraubendreher- und Steckschlüssel-Einsätzen

Chrom-Vanadium, CPP = verchromt, ganz poliert
Metallkasten 174 x 81 x 31 mm

Combined set of sockets and screwdriver sockets

Chrome-Vanadium, CPP = chromium plated, fully polished
Metal case 174 x 81 x 31 mm

Compositions de douilles et de douilles-tournevis

Chrom-Vanadium, CPP = chromées, entièrement polies
Coffret métallique 174 x 81 x 31 mm

Juegos de llaves de vaso con destornillador

Cromo Vanadio, CPP = cromado, enteramente pulido espejo
Caja metálica 174 x 81 x 31 mm



für TORX®-Schrauben/for TORX®-screws

Code	No.	tlg./pcs.			EAN
00025500083	25-50-E/T	17	515	1	125337

enthaltend/containing			
Stck./pcs.	Artikel/article	No.	Maße/dimensions
6		25-20	E 4 E 5 E 6 E 7 E 8 E 10
11		25-36	T 6 T 7 T 8 T 9 T 10 T 15 T 20 T 25 T 27 T 30 T 40



27-3010 - 27-4010

Steckschlüssel-Garnituren

Chrom-Vanadium, CPP = verchromt, ganz poliert
Metallkasten 174 x 81 x 31 mm

Socket sets

Chrome-Vanadium, CPP = chromium plated, fully polished
Metal case 174 x 81 x 31 mm

Compositions de douilles

Chrom-Vanadium, CPP = chromées, entièrement polies
Coffret métallique 174 x 81 x 31 mm

Juegos de llaves de vaso

Cromo Vanadio, CPP = cromado, enteramente pulido espejo
Caja metálica 174 x 81 x 31 mm



Code	No.	tlg./pcs.			EAN
00027301083	27-3010-M	17	700	1	099683

enthaltend/containing			
Stck./pcs.	Artikel/article	No.	Maße/dimensions
12		25-6	MM 4 4,5 5 5,5 6 7 8 9 10 11 12 13
1		25-00-15	140 mm – 72 Zähne /teeth/dents/dientes
1		25-03	115 mm
1		25-05	100 mm
1		25-06	35 mm
1		25-08	145 mm

Code	No.	tlg./pcs.			EAN
00027401083	27-4010-AF	17	690	1	099690

wie/as 27-3010-M, jedoch/but			
Stck./pcs.	Artikel/article	No.	Maße/dimensions
12		25-6	AF 1/8 5/32 3/16 7/32 1/4 9/32 5/16 11/32 3/8 7/16 1/2 9/16





27-3510

Steckschlüssel-Garnitur

Chrom-Vanadium, CPP = verchromt, ganz poliert
Metallkasten 225 x 115 x 38 mm

Socket set

Chrome-Vanadium, CPP = chromium plated, fully polished
Metal case 225 x 115 x 38 mm

Compositions de douilles

Chrome-Vanadium, CPP = chromées, entièrement polies
Coffret métallique 225 x 115 x 38 mm

Juegos de llaves de vaso

Cromo Vanadio, CPP = cromado, enteramente pulido espejo
Caja metálica 225 x 115 x 38 mm



Code	No.	tlg./pcs.			EAN
00027351083	27-3510-M	18	960	1	096736

enthaltend/containing

Stck./pcs.	Artikel/article	No.	Maße/dimensions
12		25-6	MM 4 4,5 5 5,5 6 7 8 9 10 11 12 13
1		25-00-15	140 mm – 72 Zähne /teeth/dents/dientes
1		25-03	115 mm
1		25-04	50 mm
1		25-05-1	150 mm
1		25-06	35 mm
1		25-08	145 mm

29-3010

Steckschlüssel-Garnitur

Chrom-Vanadium, CPP = verchromt, ganz poliert
Metallkasten 320 x 120 x 38 mm

Socket set

Chrome-Vanadium, CPP = chromium plated, fully polished
Metal case 320 x 120 x 38 mm

Compositions de douilles

Chrome-Vanadium, CPP = chromées, entièrement polies
Coffret métallique 320 x 120 x 38 mm

Juegos de llaves de vaso

Cromo Vanadio, CPP = cromado, enteramente pulido espejo
Caja metálica 320 x 120 x 38 mm



Code	No.	tlg./pcs.			EAN
00029301083	29-3010-M	29	1349	1	099706

enthaltend/containing

Stck./pcs.	Artikel/article	No.	Maße/dimensions
12		25-6	MM 4 4,5 5 5,5 6 7 8 9 10 11 12 13
2		25-30	5,5 6,5 mm
5		25-31	MM 3 4 5 6 8
4		25-32	PH No. 1 2 3 4
1		25-00-15	140 mm – 72 Zähne /teeth/dents/dientes
1		25-03	115 mm
1		25-04	50 mm
1		25-05	100 mm
1		25-06	35 mm
1		25-08	145 mm



30-3010

Kombinierte Steckschlüssel-Garnitur

Chrom-Vanadium, CPP = verchromt, ganz poliert
Metallkasten 407 x 162 x 52 mm

Combined set of Sockets

Chrome-Vanadium, CPP = chromium plated, fully polished
Metal case 407 x 162 x 52 mm

Compositions de douilles

Chrome-Vanadium, CPP = chromées, entièrement polies
Coffret métallique 407 x 162 x 52 mm

Juegos combinados de llaves de vaso

Cromo Vanadio, CPP = cromado, enteramente pulido espejo
Caja metálica 407 x 162 x 52 mm



Code	No.	tlg./pcs.			EAN
00030301083	30-3010-M	49	3265	1	114003

enthaltend/containing

Stck./pcs.	Artikel/article	No.	Maße/dimensions
8		25-6	MM 4 4,5 5 5,5 6 7 8 9
1		25-00-15	140 mm – 72 Zähne /teeth/dents/dientes
1		25-05	100 mm
1		25-06	35 mm
1		25-08	145 mm
12		40-6	MM 10 11 12 13 14 15 16 17 18 19 21 22
1		40-00-10	195 mm – 48 Zähne /teeth/dents/dientes
1		40-03	200 mm
1		40-04	125 mm
1		40-05	250 mm
1		40-06	50 mm
1		40-14	25 mm
1		40-19-1	MM 20,8
1		40-19-3	AF 5/8
6		3500	3 3,5 4 5,5 6,5 8 mm
5		3510	MM 3 4 5 6 8
3		3520	PH No. 1 2 3
1		3530	PZ No. 2
1		6201-30	30 mm
1		6101-30	25 mm

31-1910

Steckschlüssel-Garnitur

Chrom-Vanadium, CPP = verchromt, ganz poliert
Metallkasten 320 x 120 x 38 mm

Socket set

Chrome-Vanadium, CPP = chromium plated, fully polished
Metal case 320 x 120 x 38 mm

Compositions de douilles

Chrome-Vanadium, CPP = chromées, entièrement polies
Coffret métallique 320 x 120 x 38 mm

Juegos de llaves de vaso

Cromo Vanadio, CPP = cromado, enteramente pulido espejo
Caja metálica 320 x 120 x 38 mm



Code	No.	tlg./pcs.			EAN
00031191083	31-1910-M	28	1688	1	366488

enthaltend/containing

Stck./pcs.	Artikel/article	No.	Maße/dimensions
12		25-6	MM 4 4,5 5 5,5 6 7 8 9 10 11 12 13
10		25-19	MM 4 5 6 7 8 9 10 11 12 13
1		25-00-15	140 mm – 72 Zähne /teeth/dents/dientes
1		25-03	114 mm
1		25-04	55 mm
1		25-05-1	150 mm
1		25-06	35 mm
1		25-08	145 mm



ANTRIEBS- UND VERBINDUNGSTEILE

DRIVE AND CONNECTING PARTS

Chrom-Vanadium
C = verchromt
CPP = verchromt, ganz poliert
mit Kugel-Arretierung

Chrome-Vanadium
C = chromium plated
CPP = chromium plated, fully polished
with spring-loaded retaining ball

40-00-10/-15

DIN 3122 D · ISO 3315

Hebelumschaltknarre VARICAT

Reversible ratchet VARICAT

Cliquet réversible à levier VARICAT

Carraca reversible VARICAT



48 Zähne/teeth/dents/dientes



72 Zähne/teeth/dents/dientes

Code	No.	Ausf. finish	←L→ mm	g		EAN
00040010083	40-00-10	CPP	195	269	1	001501
00040010583	40-00-15	CPP	195	269	1	404289

40-00-27

Aufsteck-Umschaltknarre

Reversible ratchet unit

Cliquet réversible adaptateur

Cabeza de carraca reversible



60 Zähne/teeth/dents/dientes

Code	No.	Ausf. finish	←L→ mm	g		EAN
00040027082	40-00-27	CP	50	200	5	001563

40-02

DIN 3122 B · ISO 3315

Kurbel

Speed brace

Vilebrequin

Berbiqui



Code	No.	Ausf. finish	←L→ mm	g		EAN
00040020083	40-02	CPP	304	260	5	098235

40-03

DIN 3122 A · ISO 3315

Griff mit Gleitstück

Sliding T-handle

Poignée coulissante

Mango corredizo



Code	No.	Ausf. finish	←L→ mm	g		EAN
00040030083	40-03	CPP	200	160	10	098242



40-04/-1 40-05

DIN 3123 B · ISO 3316

Verlängerung

Extension bar

Rallonge

Alargadera



Code	No.	Ausf. finish	←L→ mm	g		EAN
00040041083	40-04-1	CPP	75	62	10	099119
00040040083	40-04	CPP	125	90	10	098259
00040050083	40-05	CPP	250	165	10	098266

40-04-15/-25 40-05-5

Schwenkbare Verlängerung

Wobble extension

Rallonge articulée

Alargadera oscilante

40-04-15
40-04-25 =
40-05-5



Code	No.	Ausf. finish	←L→ mm	g		EAN
00040041583	40-04-15	CPP	75	60	10	103021
00040042583	40-04-25	CPP	150	105	10	103038
00040055083	40-05-5	CPP	250	165	10	103045

40-06

DIN 3123 C · ISO 3316

Kardangeln

Universal joint

Cardan universel

Articulación universal



Code	No.	Ausf. finish	←L→ mm	g		EAN
00040060083	40-06	CPP	50	60	10	098273

40-07

DIN 3122 F · ISO 3315

Gelenkgriff

Swivel handle

Poignée articulée

Mango articulado



Code	No.	Ausf. finish	←L→ mm	g		EAN
00040070083	40-07	CPP	224	215	10	098280

40-14/-15

DIN 3123 A · ISO 3316

Verbindungsstück

Converter

Réducteur

Reductor

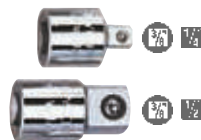

Code	No.	Ausf. finish	←L→ mm	g		EAN
00040140083	40-14	CPP	25	30	10	098297
00040150083	40-15	CPP	35	50	10	098303

40-16

DIN 3122 CV · ISO 3315

Verbindungsvierkant

Square coupler

Carré conducteur

Adaptador



Code	No.	Ausf. finish	←L→ mm	g		EAN
00040160083*	40-16	CPP	25	15	10	098310

6201-30

Adapter

Adapter

Adaptateur

Adaptador



Code	No.	Ausf. finish	←L→ mm	g		EAN
06201003080	6201-30	C	20	20	10	036589



40-6

DIN 3124 / ISO 2725



Steckschlüssel-Einsätze

Chrom-Vanadium, CPP = verchromt, ganz poliert mit Kugelfangrinne

Sockets

Chrome-Vanadium, CPP = chromium plated, fully polished, with ball retaining groove

Douilles

Chrom-Vanadium, CPP = chromées, entièrement polies avec gorge de verrouillage pour bille

Llaves de vaso

Cromo Vanadio, CPP = cromado, cabeza pulida espejo con ranura de retención por bola

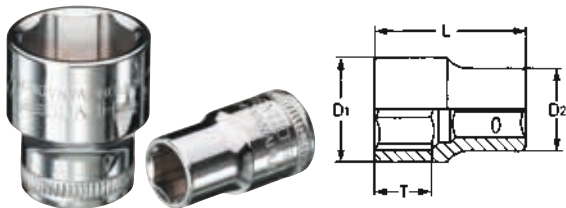

Code	ØMM	←L→ mm	T mm	D ₁ mm	D ₂ mm	g		EAN
00040600683	6	25,5	8,0	9,3	17,0	18	10	099058
00040600783	7	25,5	8,0	10,9	17,0	18	10	099065
00040600883	8	25,5	8,0	12,0	17,0	20	10	098327
00040600983	9	25,5	8,0	13,4	17,0	20	10	098334
00040601083	10	25,5	8,5	14,6	17,0	22	10	098341
00040601183	11	25,5	8,5	15,9	17,0	22	10	098358
00040601283	12	25,5	8,5	17,0	17,0	23	10	098365
00040601383	13	25,5	9,0	18,0	18,0	28	10	098372
00040601483	14	26,0	10,5	19,6	19,6	32	10	098389
00040601583	15	27,0	13,0	21,0	21,0	39	10	098396
00040601683	16	27,0	13,0	22,0	22,0	42	10	098402
00040601783	17	27,0	13,0	23,4	23,4	51	10	098419
00040601883	18	27,0	13,0	24,0	24,0	51	10	098426
00040601983	19	29,0	15,0	26,0	24,0	58	10	098433
00040602083	20	29,0	15,0	27,1	25,5	60	10	098440
00040602183	21	29,0	15,0	28,0	26,0	68	10	098457
00040602283	22	31,0	17,0	29,6	27,0	80	10	098464

40-12

DIN 3124 / ISO 2725



Steckschlüssel-Einsätze

Chrom-Vanadium, CPP = verchromt, ganz poliert mit Kugelfangrinne

Sockets

Chrome-Vanadium, CPP = chromium plated, fully polished, with ball retaining groove

Douilles

Chrom-Vanadium, CPP = chromées, entièrement polies avec gorge de verrouillage pour bille

Llaves de vaso

Cromo Vanadio, CPP = cromado, cabeza pulida espejo con ranura de retención por bola

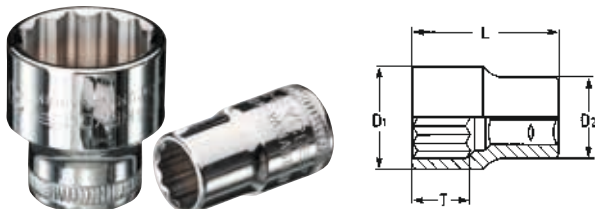

Code	ØMM	←L→ mm	T mm	D ₁ mm	D ₂ mm	g		EAN
00040000683	6	25,5	8,0	9,3	17,0	18	10	099089
00040000783	7	25,5	8,0	10,9	17,0	18	10	099072
00040000883	8	25,5	8,0	12,0	17,0	20	10	098471
00040000983	9	25,5	8,0	13,4	17,0	20	10	098488
00040001083	10	25,5	8,5	14,6	17,0	22	10	098495
00040001183	11	25,5	8,5	15,9	17,0	22	10	098501
00040001283	12	25,5	8,5	17,0	17,0	22	10	098518
00040001383	13	25,5	9,0	18,0	18,0	27	10	098525
00040001483	14	26,0	10,5	19,6	19,6	32	10	098532
00040001583	15	27,0	13,0	21,0	21,0	38	10	098549
00040001683	16	27,0	13,0	22,0	22,0	42	10	098556
00040001783	17	27,0	13,0	23,4	23,4	48	10	098563
00040001883	18	27,0	13,0	24,0	24,0	49	10	098570
00040001983	19	29,0	15,0	26,0	24,0	57	10	098587
00040002083	20	29,0	15,0	27,1	25,5	64	10	098594
00040002183	21	29,0	15,0	28,0	26,0	68	10	098600
00040002283	22	31,0	17,0	29,6	27,0	78	10	098617

40-12

DIN 3124 / ISO 2725



Steckschlüssel-Einsätze

Chrom-Vanadium, CPP = verchromt, ganz poliert mit Kugelfangrinne

Sockets

Chrome-Vanadium, CPP = chromium plated, fully polished, with ball retaining groove

Douilles

Chrom-Vanadium, CPP = chromées, entièrement polies avec gorge de verrouillage pour bille

Llaves de vaso

Cromo Vanadio, CPP = cromado, cabeza pulida espejo con ranura de retención por bola

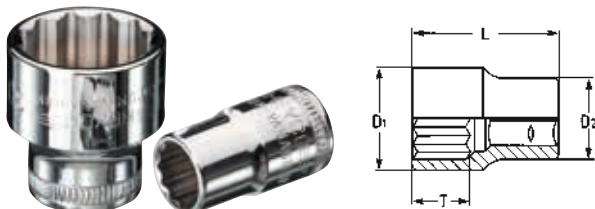

Code	ØAF	←L→ mm	T mm	D ₁ mm	D ₂ mm	g		EAN
00040031283	1/4	25,5	8,0	10,0	17,0	18	10	098624
00040031483	9/32	25,5	8,0	11,0	17,0	18	10	098631
00040031683	5/16	25,5	8,0	12,0	17,0	20	10	098648
00040031883	11/32	25,5	8,0	12,5	17,0	20	10	098655
00040031983	3/8	25,5	8,0	14,5	17,0	22	10	098662
00040032183	7/16	25,5	8,5	16,0	17,0	23	10	098679
00040032383	1/2	25,5	9,0	18,0	18,0	26	10	098686
00040032583	9/16	26,5	10,5	20,0	20,0	34	10	098693
00040032683	19/32	27,0	13,0	21,0	21,0	38	10	098709
00040032783	5/8	27,0	13,0	22,0	22,0	44	10	098716
00040032883	21/32	27,0	13,0	23,0	23,4	50	10	098723
00040032983	11/16	27,0	13,0	24,0	24,0	52	10	098730
00040033183	3/4	29,0	15,0	26,0	24,0	57	10	098747
00040033283	25/32	29,0	15,0	27,1	25,5	64	10	098754
00040033383	13/16	29,0	15,0	28,0	26,0	68	10	098761
00040033483	7/8	31,0	17,0	30,0	27,0	81	10	098778

40-17-1/2

Glühkerzeneinsätze mit Gelenk

- Chrom-Vanadium, verchromt
- Mit geschraubtem Kardangelenk
- Ideal für enge Bauräume
- Mit Gummieinsatz zum Halten der losen Glühkerze

Glow plug sockets with joint

- Chrome-Vanadium, chromium plated
- With bolted universal joint
- Ideal for restricted locations
- With rubber insert to hold the loose glow plug

Clés à bougies

- Acier chromé
- Avec cardan vissé
- Idéal pour les accès difficiles
- Avec insert en caoutchouc pour maintenir le bougie

Llave para bujías, articulada

- Cromo vanadio, cromadas
- Con articulación Kardan
- Ideal para espacios reducidos
- Con injerto de goma para sujetar la bujía

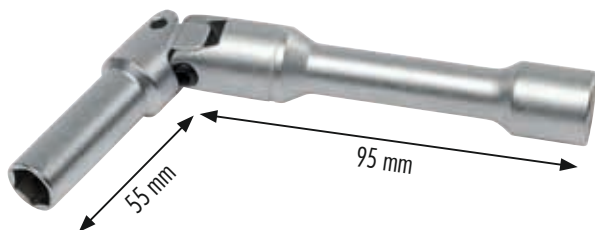

Code	No.	ØMM	←L→ mm	g		EAN
00040170183	40-17-1	8	160	180	5	394221
00040170283	40-17-2	10	160	180	5	394238

40-18-1/2

Zündkerzeneinsätze, extra lang

- Chrom-Vanadium, verchromt, teilweise poliert
- Besonders gut geeignet für extrem tiefsitzende Kerzen
- Kreuzrändelung für mehr Grip
- Dünnwandig

Spark plug sockets, extra deep

- Chrome-Vanadium, chromium plated, head polished
- Best suited for extremely deep mounted spark/glow plug sockets
- Cross knurling provides better grip
- Thin walls

Douille pour bougie extra longue

- Chrome-Vanadium, chromé, partiellement polis
- Particulièrement adapté pour les bougies extrêmement profond
- Moleté pour plus de prise
- Parois minces

Llaves de vaso para bujías extra-largas

- Cromo vanadio, cromadas, parcialmente pulida
- Especialmente apta para bujías en alojamiento profundo
- Grafilado para mejor agarre
- Paredes delgadas

Code	No.	ØMM	←L→ mm	g		EAN
00040180183	40-18-1	14	250	280	5	394061
00040180283	40-18-2	16	250	280	5	394085

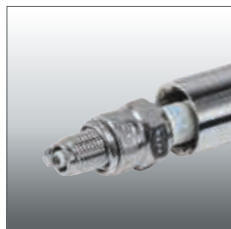



40-19-1 - 40-19-3

~ DIN 3124 / ISO 2725



Steckschlüssel-Einsätze für Zündkerzen

Chrom-Vanadium, CP = verchromt, teilweise poliert
extra lang, mit Kugelfangrinne, mit Gummieinsatz,
19 mm Außen-Sechskant

Spark plug sockets

Chrome-Vanadium, CP = chromium plated, head polished,
extra deep, with ball retaining groove, with rubber insert,
19 mm hexagon plug

Douilles pour bougies

Chrom-Vanadium, CP = chromées, partiellement polies
avec gorge de verrouillage pour bille,
extra longues; avec bague de caoutchouc de retenue de la bougie,
19 mm embase

Llaves de vaso para bujías

Cromo Vanadio, CP = cromado, cabeza pulida espejo
extra-largas, con ranura de retención, por bola, con injerto de goma,
hexágono exterior de 19 mm

Code	No.	MM	AF	←L→ mm	T mm	D mm	g		EAN
00040190183	40-19-1	20,8	13/16	65	15,0	28,0	140	10	098785
00040190383	40-19-3	16	5/8	65	15,0	22,0	100	10	098808

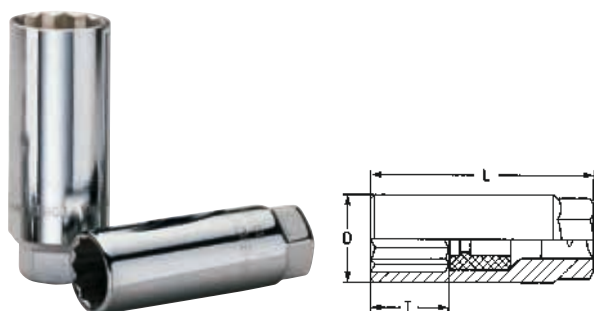

40-20



Steckschlüssel-Einsätze

Chrom-Vanadium, CPP = verchromt, ganz poliert
mit Kugelfangrinne
für Außen-TORX®-Schrauben

Sockets

Chrome-Vanadium, CPP = chromium plated, fully polished
with ball retaining groove
for TORX®-head screws

Douilles

Chrom-Vanadium, CPP = chromées, entièrement polies
avec gorge de verrouillage pour bille
pour vis TORX®-extérieures

Llaves de vaso

Cromo Vanadio, CPP = cromado, cabeza pulida espejo
con ranura de retención por bola
para tornillos TORX® exteriores

Code	Größe size	mm	←L→ mm	T mm	D ₁ mm	D ₂ mm	g		EAN
00040200583	E 5	4,75	28	5	7,0	17	20	10	112771
00040200683	E 6	5,74	28	6	8,0	17	22	10	112788
00040200783	E 7	6,22	28	7	9,0	17	25	10	112795
00040200883	E 8	7,52	28	7	10,0	17	28	10	112801
00040201083	E 10	9,42	28	8	12,0	17	30	10	112818
00040201283	E 12	11,17	28	8	14,5	17	32	10	112825
00040201483	E 14	12,90	28	10	16,5	17	35	10	112832

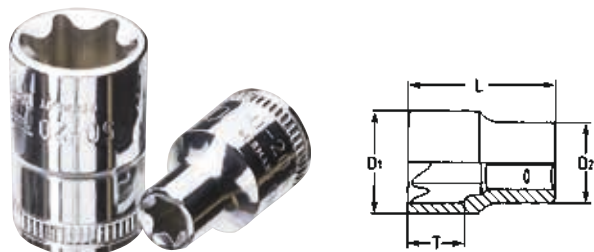

40-30 - 40-36

Schraubendreher-Einsätze

Körper: Chrom-Vanadium, CPP = verchromt, ganz poliert mit Kugelfangrinne

Bits: Sonderstahl, PH = phosphatiert

Screwdriver sockets

Socket bodies: Chrome-Vanadium, CPP = chromium plated, fully polished, with ball retaining groove

Bits: Special steel, PH = phosphated

Douilles tournevis

Socket bodies: Chrome-Vanadium, CPP = chromées, entièrement polies avec gorge de verrouillage pour bille

Embouts: Acier Spécial, PH = phosphaté

Llaves de vaso con destornillador

Cuerpo: Cromo Vanadio, CPP = cromado, enteramente pulido espejo, con ranura de retención por bola

Puntas: Acero aleado, PH = fosfatado



40-30



40-31



40-32



40-35



40-36

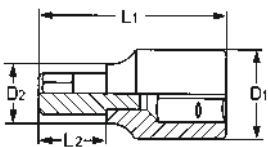

40-30 für Schlitz-Schrauben/for plain slot screws

Code	mm	mm	L ₁ mm	L ₂ mm	D ₁ mm	D ₂ mm	g	g	EAN
00040300183	5,5	1,0	52	22	19	14	42	10	001709
00040300283	8,0	1,2	52	22	19	15	47	10	001716
00040300383	10,0	1,6	52	22	19	16	49	10	001723

40-31 für Innensechskant-Schrauben/for hexagon socket screws, DIN 7422/ISO 1174

Code	MM	L ₁ mm	L ₂ mm	D ₁ mm	D ₂ mm	g	g	EAN
00040310183	4	42	12	19	14	41	10	001730
00040310283	5	42	12	19	14	41	10	001747
00040310383	6	42	12	19	14	42	10	001754
00040310783	7	42	12	19	14	43	10	172270
00040310483	8	42	12	19	15	45	10	001761
00040310583	10	42	12	19	16	49	10	001778

40-31 für Innensechskant-Schrauben/for hexagon socket screws, DIN 7422/ISO 1174

Code	AF	L ₁ mm	L ₂ mm	D ₁ mm	D ₂ mm	g	g	EAN
00040313083	1/8	42	12	19	14	40	10	001785
00040313183	5/32	42	12	19	14	40	10	001792
00040313283	3/16	42	12	19	14	42	10	001808
00040313383	7/32	42	12	19	14	42	10	001815
00040313483	1/4	42	12	19	15	43	10	001822
00040313683	5/16	42	12	19	15	45	10	001839
00040313883	3/8	42	12	19	16	49	10	001846

40-32 für Kreuzschlitz-Schrauben/for cross slot screws PHILLIPS-RECESS

Code	No.	L ₁ mm	L ₂ mm	D ₁ mm	D ₂ mm	g	g	EAN
00040320183	1	46	16	19	14	41	10	001853
00040320283	2	46	16	19	14	41	10	001860
00040320383	3	46	16	19	15	43	10	001877

40-35 für Kreuzschlitz-Schrauben/for cross slot screws POZIDRIV®

Code	No.	L ₁ mm	L ₂ mm	D ₁ mm	D ₂ mm	g	g	EAN
00040350183	1	46	16	19	14	40	10	001891
00040350283	2	46	16	19	14	41	10	001907
00040350383	3	46	16	19	15	45	10	001914

40-36 für Innen-TORX®-Schrauben/for TORX®-socket screws

Code	Größe size	mm	L ₁ mm	L ₂ mm	D ₁ mm	D ₂ mm	g	g	EAN
00040361083	T 10	2,74	45	15	19	14	40	10	001938
00040361583	T 15	3,27	45	15	19	14	41	10	001945
00040362083	T 20	3,86	45	15	19	15	42	10	001952
00040362583	T 25	4,43	45	15	19	15	42	10	001969
00040362783	T 27	4,99	45	15	19	15	42	10	001976
00040363083	T 30	5,52	45	15	19	15	42	10	001983
00040364083	T 40	6,65	45	15	19	15	44	10	001990
00040364583	T 45	7,82	45	15	19	15	45	10	002003
00040365083	T 50	8,83	48	18	19	16	49	10	002010



40-50

Satz mit Schraubendreher- und Steckschlüssel-Einsätzen

Chrom-Vanadium, CPP = verchromt, ganz poliert
Metallkasten 225 x 115 x 38 mm

Combined set of sockets and screwdriver sockets

Chrome-Vanadium, CPP = chromium plated, fully polished
Metal case 225 x 115 x 38 mm

Compositions de douilles et de douilles-tournevis

Chrome-Vanadium, CPP = chromées, entièrement polies
Coffret métallique 225 x 115 x 38 mm

Juegos de llaves de vaso con destornillador

Cromo Vanadio, CPP = cromado, enteramente pulido espejo
Caja metálica 225 x 115 x 38 mm



für TORX®-Schrauben/for TORX®-screws

Code	No.	tlg./pcs.			EAN
00040500083	40-50-E/T	16	1040	1	125344

enthaltend/containing

Stck./pcs.	Artikel/article	No.	Maße/dimensions
7		40-20	E5 E6 E7 E8 E10 E12 E14
9		40-36	T10 T15 T20 T25 T27 T30 T40 T45 T50



40-70 - 40-71

Steckschlüssel-Einsätze auf Aluminium-Klemmleiste, 16-tlg.

Aluminium-Klemmleiste grün eloxiert.
Chrom-Vanadium, CPP = verchromt, ganz poliert
mit Kugelfangrinne

Sockets on aluminium socket rail, 16 pcs.

Aluminium socket rail, anodized.
Chrome-Vanadium, CPP = chromium plated, fully polished,
with ball retaining groove

Assortiment douilles sur bande alu, 16 pcs.

Bloc aluminium anodisé.
Chrome-Vanadium, CPP = chromées, entièrement polies
avec gorge de verrouillage pour bille

Juego de 16 llaves de vaso en regla de sujeción de aluminio

Regla de sujeción, de aluminio anodizado color verde.
Cromo Vanadio, CPP = cromado, cabeza pulida espejo
con ranura de retención por bolae



Code	No.	tlg./pcs.			EAN
00040700083	40-70-M	16	891	1	366723

enthaltend/containing

Stck./pcs.	Artikel/article	No.	Maße/dimensions
16		40-6-M	MM 6 7 8 9 10 11 12 13 14 15 16 17 18 19 21 22

Code	No.	tlg./pcs.			EAN
00040710083	40-71-M	16	901	1	366730

enthaltend/containing

Stck./pcs.	Artikel/article	No.	Maße/dimensions
16		40-12-M	MM 6 7 8 9 10 11 12 13 14 15 16 17 18 19 21 22

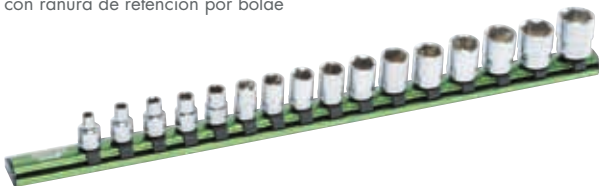

987-40

Aluminium-Klemmleiste, leer

zur Aufnahme von max. 16 Einsätzen.
Kugelgefederte Aufnahme gewährleistet perfekten Halt der Einsätze.
Sicherer Halt der Klemmleiste durch Magnet an Metallflächen.

Aluminium socket rail, empty

for max. 16 sockets.
Spring-loaded retaining ball ensures a perfect hold of the sockets.
A strong magnet securely holds the socket rail to ferrous metal.

Bornes en aluminium, vide

pour max. 16 inserts.
Les billes à ressort assurent une parfaite prise en main.
Blocage des bornes dues aux aimants et les surfaces métalliques.

Regla de aluminio anodizado color verde

para sujeción de 16 llaves de vaso.
Sujeción con muelle, garantiza una firme colocación de los vasos.
Regla sujeta por imán.



Code	No.	tlg./pcs.			EAN
98710401600	987-40	1	269	1	365283

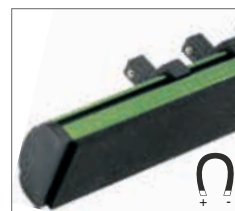
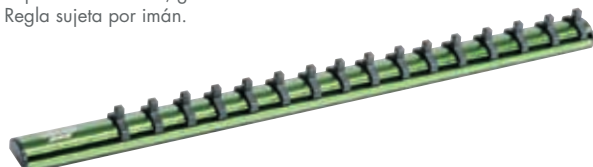

40-75 - 40-88

Kombi-Spender mit Steckschlüssel- und Schraubendreher-Einsätzen

aus Stahlblech, zum Aufstellen und Hängen; problemloses Bestücken beider Schütten durch herausnehmbares Oberteil; variable Einteilung durch Trennleistensystem, daher Zusammenstellung von Sortimenten nach Wahl möglich.

Folgende Sortimente führen wir standardmäßig:

Dispensers containing sockets and screwdriver sockets
sheet steel, for counter-display and wall mounting; simple re-filling of both dispenser units with removable upper tray; variable system of partitions permits composition of different assortments to choice.

The following assortments represent our standard range:

Présentoirs combinés avec douilles et douilles-tournevis
en tôle d'acier, à poser ou à accrocher; facile à remplir grâce à la partie supérieure amovible; cloisons réglables permettant une composition variable au choix
Les compositions suivantes sont standardisées:

Expositor combinado de llaves de vaso y vasos con destornillador

de chapa de acero, de sobremesa o para colgar; ambos cargadores facilmente recargables, gracias a la parte superior desmontable; separaciones ajustables por sistema de listones que permiten componer los surtidos a elección del usuario.
Los siguientes surtidos son standard:



40-75

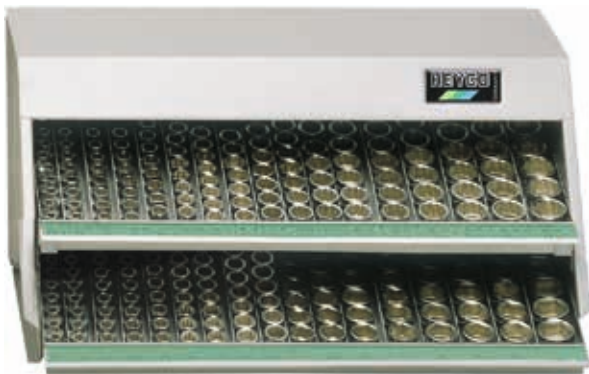

40-85

Code	No.	tlg./pcs.			EAN
00040750083	40-75-M	347	23230	1	098815

157 Doppel-6-kant Steckschlüssel-Einsätze/bihexagon sockets MM,
190 Schraubendreher-Einsätze/screwdriver sockets
enthaltend/containing

Stck./pcs.	Artikel/article	No.	Maße/dimensions
je 10 each		40-12	MM 6 7 8 9 10 11 12 13 14 15
je 9 each		40-12	MM 16 17 18
je 8 each		40-12	MM 19 20
je 7 each		40-12	MM 21 22
je 10 each		40-30	5,5 8 9 mm
je 10 each		40-31	MM 4 5 6 8 10
je 10 each		40-32	PH No. 1 2 3
je 10 each		40-35	PZ No. 1 2 3
je 10 each		40-36	T 15 T 20 T 25 T 27 T 30

Code	No.	tlg./pcs.			EAN
00040760083	40-76-M	347	23350	1	098822

157 6-kant Steckschlüssel-Einsätze/hexagon sockets MM,
190 Schraubendreher-Einsätze/screwdriver sockets
wie/as 40-75-M, jedoch/but

Stck./pcs.	Artikel/article	No.	Maße/dimensions
je 10 each		40-6	MM 6 7 8 9 10 11 12 13 14 15
je 9 each		40-6	MM 16 17 18
je 8 each		40-6	MM 19 20
je 7 each		40-6	MM 21 22

Code	No.	tlg./pcs.			EAN
00040850083	40-85-M	314	19550	1	098839

157 Doppel-6-kant Steckschlüssel-Einsätze/bihexagon sockets MM,
157 6-kant Steckschlüssel-Einsätze/hexagon sockets MM
enthaltend/containing

Stck./pcs.	Artikel/article	No.	Maße/dimensions
je 10 each		40-12	MM 6 7 8 9 10 11 12 13 14 15
je 9 each			MM 16 17 18
je 8 each		+	MM 19 20
je 7 each		40-6	MM 21 22

Code	No.	tlg./pcs.			EAN
00040880083	40-88-M/AF	314	19300	1	098846

157 Doppel-6-kant Steckschlüssel-Einsätze/bihexagon sockets MM,
157 Doppel-6-kant Steckschlüssel-Einsätze/bihexagon sockets AF
enthaltend/containing

Stck./pcs.	Artikel/article	No.	Maße/dimensions
je 10 each		40-12	MM 6 7 8 9 10 11 12 13 14 15
je 9 each		40-12	MM 16 17 18
je 8 each		40-12	MM 19 20
je 7 each		40-12	MM 21 22
je 10 each		40-12	AF 1/4 9/32 5/16 11/32 3/8 7/16
je 20 each		40-12	AF 1/2
je 10 each		40-12	AF 9/16 19/32
je 9 each		40-12	AF 5/8 21/32 11/16
je 8 each		40-12	AF 3/4 25/32
je 7 each		40-12	AF 13/16 7/8

3/8"

41-0010 - 41-3010

Steckschlüssel-Garnituren

Chrom-Vanadium, CPP = verchromt, ganz poliert
Metallkasten 318 x 119 x 49 mm

Socket sets

Chrome-Vanadium, CPP = chromium plated, fully polished
Metal case 318 x 119 x 49 mm

Compositions de douilles

Chrome-Vanadium, CPP = chromées, entièrement polies
Coffret métallique 318 x 119 x 49 mm

Juegos de llaves de vaso

Cromo Vanadio, CPP = cromado, enteramente pulido espejo
Caja metálica 318 x 119 x 49 mm



3/8"

Code	No.	tlg./pcs.	g	g	EAN
00041001083	41-0010-M	22	2490	1	100402

enthaltend/containing

Stck./pcs.	Artikel/article	No.	Maße/dimensions
17		40-12	MM 6 7 8 9 10 11 12 13 14 15 16 17 18 19 20 21 22
1		40-00-10	195 mm – 48 Zähne /teeth/dents/dientes
1		40-03	200 mm
1		40-04	125 mm
1		40-05	250 mm
1		40-06	50 mm

Code	No.	tlg./pcs.	g	g	EAN
00041301083	41-3010-M	22	2440	1	100426

wie/as 41-0010-M, jedoch/but

Stck./pcs.	Artikel/article	No.	Maße/dimensions
17		40-6	MM 6 7 8 9 10 11 12 13 14 15 16 17 18 19 20 21 22

Code	No.	tlg./pcs.	g	g	EAN
00041101083	41-1010-AF	22	2425	1	100419

wie/as 41-0010-M, jedoch/but

Stck./pcs.	Artikel/article	No.	Maße/dimensions
16		40-12	AF 1/4 9/32 5/16 11/32 3/8 7/16 1/2 9/16 19/32 5/8 21/32 11/16 3/4 25/32 13/16 7/8

43-0010 - 43-3010

Steckschlüssel-Garnituren

Chrom-Vanadium, CPP = verchromt, ganz poliert
Metallkasten 225 x 115 x 40 mm

Socket sets

Chrome-Vanadium, CPP = chromium plated, fully polished
Metal case 225 x 115 x 40 mm

Compositions de douilles

Chrome-Vanadium, CPP = chromées, entièrement polies
Coffret métallique 225 x 115 x 40 mm

Juegos de llaves de vaso

Cromo Vanadio, CPP = cromado, enteramente pulido espejo
Caja metálica 225 x 115 x 40 mm



3/8"

Code	No.	tlg./pcs.	g	g	EAN
00043001083	43-0010-M	15	1297	1	100433

enthaltend/containing

Stck./pcs.	Artikel/article	No.	Maße/dimensions
12		40-12	MM 8 9 10 11 12 13 14 15 16 17 18 19
1		40-00-10	195 mm – 48 Zähne /teeth/dents/dientes
1		40-04	125 mm
1		40-06	50 mm

Code	No.	tlg./pcs.	g	g	EAN
00043101083	43-1010-AF	15	1294	1	100464

wie/as 43-0010-M, jedoch/but

Stck./pcs.	Artikel/article	No.	Maße/dimensions
12		40-12	AF 1/4 5/16 11/32 3/8 7/16 1/2 9/16 19/32 5/8 21/32 11/16 3/4



44-0010 - 44-3010



Steckschlüssel-Garnituren

Chrom-Vanadium, CPP = verchromt, ganz poliert
Metallkasten 407 x 162 x 52 mm

Socket sets

Chrome-Vanadium, CPP = chromium plated, fully polished
Metal case 407 x 162 x 52 mm

Compositions de douilles

Chrome-Vanadium, CPP = chromées, entièrement polies
Coffret métallique 407 x 162 x 52 mm

Juegos de llaves de vaso

Cromo Vanadio, CPP = cromado, enteramente pulido espejo
Caja metálica 407 x 162 x 52 mm



Code	No.	tlg./pcs.			EAN
00044001083	44-0010-M	23	2885	1	097368

enthaltend/containing

Stck./pcs.	Artikel/article	No.	Maße/dimensions
11		40-12	MM 8 10 11 12 13 14 15 16 17 18 19
1		40-00-10	195 mm – 48 Zähne /teeth/dents/dientes
1		40-03	200 mm
1		40-04-1	75 mm
1		40-05	250 mm
1		40-06	50 mm
1		40-19-1	MM 20,8 AF 13/16
1		40-19-3	MM 16 AF 5/8
5		40-31	MM 4 5 6 8 10 mm

Code	No.	tlg./pcs.			EAN
00044301083	44-3010-M	23	2905	1	095319

wie/as 44-0010-M, jedoch/but

Stck./pcs.	Artikel/article	No.	Maße/dimensions
11		40-6	MM 8 10 11 12 13 14 15 16 17 18 19

47-0010



Steckschlüssel-Garnitur

Chrom-Vanadium, CPP = verchromt, ganz poliert
Metallkasten 318 x 119 x 49 mm

Socket set

Chrome-Vanadium, CPP = chromium plated, fully polished
Metal case 318 x 119 x 49 mm

Compositions de douilles

Chrome-Vanadium, CPP = chromées, entièrement polies
Coffret métallique 318 x 119 x 49 mm

Juegos de llaves de vaso

Cromo Vanadio, CPP = cromado, enteramente pulido espejo
Caja metálica 318 x 119 x 49 mm

für TORX®-Schrauben/for TORX®-screws

Code	No.	tlg./pcs.			EAN
00047001083	47-0010	20	2215	1	329650

enthaltend/containing

Stck./pcs.	Artikel/article	No.	Maße/dimensions
7		40-20	E 5 E 6 E 7 E 8 E 10 E 12 E 14
8		40-36	T 15 T 20 T 25 T 27 T 30 T 40 T 45 T 50
1		40-00-10	195 mm – 48 Zähne /teeth/dents/dientes
1		40-03	200 mm
1		40-04-1	75 mm
1		40-04	125 mm
1		40-06	50 mm



VOLL AUSGESTATTET! GARNITUREN VON HEYCO. FULLY EQUIPPED! SETS FROM HEYCO.

OPTIMALE AUSSTATTUNG

Es zählt zu unserer besonderen Leidenschaft, Ihnen ein maßgeschneidertes Werkzeugprogramm zusammenzustellen, immer ausgerichtet auf die jeweiligen Bedürfnisse – übersichtlich angeordnet und intelligent kombiniert.

OPTIMISED SETS OF TOOLS

One of our particular passions is being able to offer you an entire portfolio of tools that are always precisely aligned with your needs – clearly and logically categorised and intelligently combined.

UN ÉQUIPEMENT OPTIMAL

L'une de nos passions est de vous proposer une gamme d'outils sur mesure, toujours adaptée à vos besoins, clairement agencée et intelligemment combinée.

EQUIPO ÓPTIMO

Una de nuestras pasiones especiales es crear una gama de herramientas a su medida. Adaptada a las necesidades respectivas, claramente ordenadas e inteligentemente combinadas.



EINSÄTZE MIT
SCHRAUBENSCHONPROFIL
PROFILE SAVER
SOCKETS

SICHERES
VERSCHLUSSSYSTEM
SECURE LOCKING
SYSTEM

SCHWENKBARER
GRIFF
PIVOTING
HANDLE

STARKER
CHROM-VANADIUM STAHL
STRONG
CHROME VANADIUM STEEL



STABILER
METALLKASTEN
STABLE
METAL BOX

HOCHWERTIGER 2-KOMPONENTEN
SCHAUMSTOFF
HIGH GRADE 2 COMPONENTS
FOAM MATERIAL

3/8"

45-0010

Steckschlüssel-Garnituren

Chrom-Vanadium, CPP = verchromt, ganz poliert
Metallkasten 407 x 162 x 52 mm

Socket sets

Chrome-Vanadium, CPP = chromium plated, fully polished
Metal case 407 x 162 x 52 mm

Compositions de douilles

Chrome-Vanadium, CPP = chromées, entièrement polies
Coffret métallique 407 x 162 x 52 mm

Juegos de llaves de vaso

Cromo Vanadio, CPP = cromado, enteramente pulido espejo
Caja metálica 407 x 162 x 52 mm

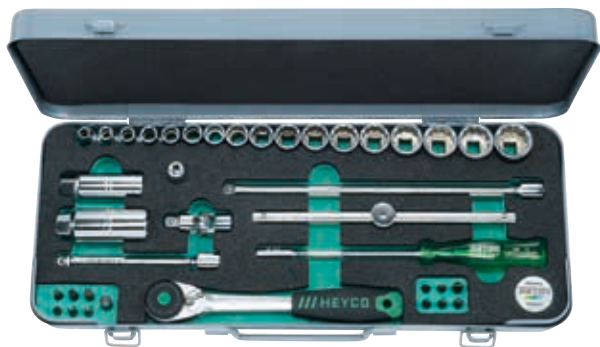

3/8"

Code	No.	tlg./pcs.	g		EAN
00045001083	45-0010-M	39	3180	1	100556

enthaltend/containing

Stk. pcs.	Artikel/article	No.	Maße/dimensions
17		40-12	MM 6 7 8 9 10 11 12 13 14 15 16 17 18 19 20 21 22
1		40-00-10	195 mm – 48 Zähne /teeth/dents/dientes
1		40-03	200 mm
1		40-04	125 mm
1		40-05	250 mm
1		40-06	50 mm
1		40-19-1	MM 20,8 AF 13/16
1		40-19-3	MM 16 AF 5/8
1		3301	225 mm
3		3500	3,5 5,5 8 mm
4		3510	MM 4 5 6 8
3		3520	PH No. 1 2 3
3		3530	PZ No. 1 2 3
1		6201-30	





ANTRIEBS- UND VERBINDUNGSTEILE DRIVE AND CONNECTING PARTS

1/2 1/2 Chrom-Vanadium
CP = verchromt, teilweise poliert
CPP = verchromt, ganz poliert
mit Kugel-Arretierung

1/2 1/2 Chrome-Vanadium
CP = chromium plated, polished head
CPP = chromium plated, fully polished
with spring-loaded retaining ball

50-00-1

DIN 3122 C · ISO 3315

Durchsteckknarre

Ratchet, push-thru type

Cliquet

Carraca de cuadradillo pasante



30 Zähne/teeth/dents/dientes

Code	No.	Ausf. finish	←L→ mm	g	g	EAN
00050011082	50-00-1	CP	270	475	5	002782

50-00-7

DIN 3122 D · ISO 3315

Umschaltknarre

Reversible ratchet

Cliquet réversible

Carraca reversible



48 Zähne/teeth/dents/dientes

Code	No.	Ausf. finish	←L→ mm	g	g	EAN
00050007082	50-00-7	CP	270	480	5	002690

50-00-10/-15

DIN 3122 D · ISO 3315

Hebelumschaltknarre VARICAT

Reversible ratchet VARICAT

Cliquet réversible à levier VARICAT

Carraca reversible VARICAT



48 Zähne/teeth/dents/dientes



72 Zähne/teeth/dents/dientes

Code	No.	Ausf. finish	←L→ mm	g	g	EAN
00050010083	50-00-10	CPP	270	576	1	002744
00050010583	50-00-15	CPP	270	576	1	404296

50-02 DIN 3122 B · ISO 3315

Kurbel

Speed brace

Vilebrequin

Berbiqui



Code	No.	Ausf. finish	←L→ mm	g	g	EAN
00050020083	50-02	CPP	405	590	5	002843

50-03 DIN 3122 A · ISO 331

Griff mit Gleitstück

Sliding T-handle

Poignée coulissante

Mango corredizo



Code	No.	Ausf. finish	←L→ mm	g	g	EAN
00050030083	50-03	CPP	300	400	10	002874



50-04-1 50-04 50-05 DIN 3123 B · ISO 3316

Verlängerung

Extension bar

Rallonge

Alargadera



Code	No.	Ausf. finish	←L→ mm	g		EAN
00050041083	50-04-1	CPP	75	130	10	003154
00050040083	50-04	CPP	125	180	10	003130
00050050083	50-05	CPP	250	325	10	003185

50-04-25 50-04-5 50-05-5

Schwenkbare Verlängerung

Wobble extension

Rallonge articulée

Alargadera oscilante



50-04-5
50-04-25 =
50-05-5



Code	No.	Ausf. finish	←L→ mm	g		EAN
00050042583	50-04-25	CPP	50	90	10	103052
00050045083	50-04-5	CPP	125	180	10	103069
00050055083	50-05-5	CPP	250	325	10	103076

50-06 DIN 3123 C · ISO 3316

Kardangelenk

Universal joint

Cardan universel

Articulación universal



Code	No.	Ausf. finish	←L→ mm	g		EAN
00050060083	50-06	CPP	70	160	10	003215

50-08 DIN 3122 F · ISO 3315

Gelenkgriff

Swivel handle

Poignée articulée

Mango articulado



Code	No.	Ausf. finish	←L→ mm	g		EAN
00050080083	50-08	CPP	385	675	5	003352

50-10 DIN 3122 G · ISO 3315

Winkelgriff

Offset handle

Poignée coudée

Mango acodado



Code	No.	Ausf. finish	←L→ mm	g		EAN
00050100083	50-10	CPP	200	270	10	003376

50-14-1 50-15 DIN 3123 A · ISO 3316

Verbindungsstück

Converter

Réducteur

Reductor



Code	No.	Ausf. finish	←L→ mm	g		EAN
00050141083	50-14-1	CPP	36	52	10	003383
00050150083	50-15	CPP	45	120	10	003390

50-16 DIN 3122 CV · ISO 3315

Verbindungsvierkant

Square coupler

Carré conducteur

Adaptador



Code	No.	Ausf. finish	←L→ mm	g		EAN
00050160083	50-16	CPP	34	45	10	003406



50-6

DIN 3124 / ISO 2725



Steckschlüssel-Einsätze

Chrom-Vanadium, CPP = verchromt, ganz poliert mit Kugelfangrinne

Sockets

Chrome-Vanadium, CPP = chromium plated, fully polished, with ball retaining groove

Douilles

Chrom-Vanadium, CPP = chromées, entièrement polies, avec gorge de verrouillage pour bille

Llaves de vaso

Cromo Vanadio, CPP = cromado, cabeza pulida espejo con ranura de retención por bola

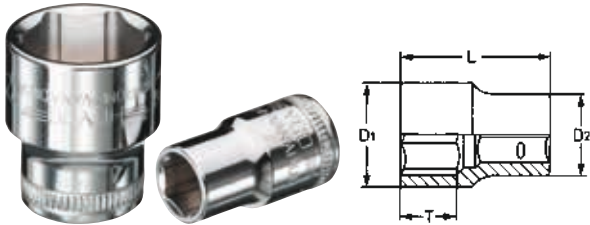

Code	MM	L mm	T mm	D ₁ mm	D ₂ mm	g	g	EAN
00050600583	5	40	6,5	8,6	22,5	53	10	004489
00050605583	5,5	40	6,5	9,2	22,5	54	10	004762
00050600683	6	40	6,5	9,8	22,5	50	10	004496
00050600783	7	40	9,5	11,0	22,5	55	10	004502
00050600883	8	40	9,5	12,0	22,5	55	10	004519
00050600983	9	40	11,0	13,2	22,5	55	10	004526
00050601083	10	40	13,5	14,6	22,5	55	10	004533
00050601183	11	40	15,0	16,4	22,5	57	10	004540
00050601283	12	40	15,0	17,8	22,5	57	10	004557
00050601383	13	40	15,0	19,0	22,5	60	10	004564
00050601483	14	40	15,0	20,3	22,5	60	10	004571
00050601583	15	40	15,0	21,5	23,0	68	10	004588
00050601683	16	40	15,0	22,5	23,0	68	10	004595
00050601783	17	40	15,0	24,0	23,0	70	10	004601
00050601883	18	40	15,0	25,0	23,0	78	10	004618
00050601983	19	40	15,0	26,5	23,0	78	10	004625
00050602083	20	40	15,0	27,8	23,0	83	10	004632
00050602183	21	40	15,0	28,8	23,0	83	10	004649
00050602283	22	40	16,0	30,3	24,0	90	10	004656
00050602383	23	43	18,0	31,6	25,0	110	10	004663
00050602483	24	43	18,0	32,8	26,0	115	10	004670
00050602583	25	43	18,0	33,8	28,0	135	10	004687
00050602683	26	43	18,0	35,0	28,0	140	10	004694
00050602783	27	43	18,0	36,5	29,0	150	10	004700
00050602883	28	43	18,0	37,7	30,0	160	10	004717
00050602983	29	43	18,0	38,8	31,0	185	10	004724
00050603083	30	43	18,0	40,2	29,0	170	10	004731
00050603283	32	43	18,0	42,4	29,0	180	10	004748
00050603483	34	43	18,0	45,0	29,0	194	10	004755

50-12

DIN 3124 / ISO 2725



Steckschlüssel-Einsätze

Chrom-Vanadium, CPP = verchromt, ganz poliert mit Kugelfangrinne

Sockets

Chrome-Vanadium, CPP = chromium plated, fully polished with ball retaining groove

Douilles

Chrom-Vanadium, CPP = chromées, entièrement polies avec gorge de verrouillage pour bille

Llaves de vaso

Cromo Vanadio, CPP = cromado, cabeza pulida espejo con ranura de retención por bola

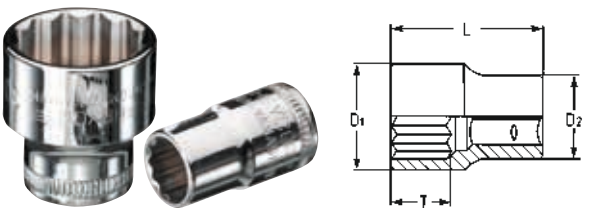

Code	MM	L mm	T mm	D ₁ mm	D ₂ mm	g	g	EAN
00050000883	8	40	9,5	12,0	22,5	53	10	002331
00050000983	9	40	11,0	13,2	22,5	53	10	002348
00050001083	10	40	13,5	14,6	22,5	53	10	002362
00050001183	11	40	15,0	16,4	22,5	55	10	002379
00050001283	12	40	15,0	17,8	22,5	55	10	002393
00050001383	13	40	15,0	19,0	22,5	58	10	002416
00050001483	14	40	15,0	20,3	22,5	58	10	002430
00050001583	15	40	15,0	21,5	23,0	66	10	002454
00050001683	16	40	15,0	22,5	23,0	66	10	002478
00050001783	17	40	15,0	24,0	23,0	68	10	002492
00050001883	18	40	15,0	25,0	23,0	74	10	002508
00050001983	19	40	15,0	26,5	23,0	74	10	002522
00050002083	20	40	15,0	27,8	23,0	79	10	002539
00050002183	21	40	15,0	28,8	23,0	79	10	002546
00050002283	22	40	16,0	30,3	24,0	86	10	002553
00050002383	23	43	18,0	31,6	25,0	105	10	002560
00050002483	24	43	18,0	32,8	26,0	110	10	002584
00050002583	25	43	18,0	33,8	28,0	130	10	002591
00050002683	26	43	18,0	35,0	28,0	135	10	002607
00050002783	27	43	18,0	36,5	29,0	145	10	002614
00050002883	28	43	18,0	37,7	30,0	155	10	002621
00050002983	29	43	18,0	38,8	31,0	180	10	002638
00050003083	30	43	18,0	40,2	29,0	165	10	002645
00050003283	32	43	18,0	42,4	29,0	175	10	002652
00050003383	33	43	18,0	44,0	29,0	170	10	002669
00050003483	34	43	18,0	45,0	29,0	192	10	002676



50-12

DIN 3124 / ISO 2725



Steckschlüssel-Einsätze

Chrom-Vanadium, CPP = verchromt, ganz poliert mit Kugelfangrinne

Sockets

Chrome-Vanadium, CPP = chromium plated, fully polished with ball retaining groove

Douilles

Chrom-Vanadium, CPP = chromées, entièrement polies avec gorge de verrouillage pour bille

Llaves de vaso

Cromo Vanadio, eza pulida espejo con ranura de retención por bola

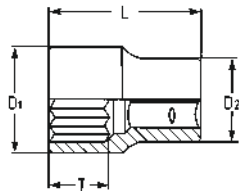

Code	AF	←L→ mm	T mm	D ₁ mm	D ₂ mm	g		EAN
00050031983	3/8	40	12,0	14,0	22,5	53	10	002881
00050032183	7/16	40	15,0	16,4	22,5	53	10	002904
00050032383	1/2	40	15,0	17,8	22,5	57	10	002928
00050032583	9/16	40	15,0	20,3	22,5	60	10	002942
00050032683	19/32	40	15,0	21,5	23,0	66	10	002959
00050032783	5/8	40	15,0	22,5	23,0	66	10	002966
00050032983	11/16	40	15,0	25,0	23,0	72	10	002980
00050033183	3/4	40	15,0	26,5	23,0	74	10	002997
00050033283	25/32	40	15,0	27,7	23,0	80	10	003000
00050033383	13/16	40	15,0	28,8	23,0	77	10	003017
00050033483	7/8	40	16,0	30,3	24,0	87	10	003031
00050033583	15/16	43	18,0	32,7	26,0	110	10	003048
00050033683	31/32	43	18,0	33,8	28,0	125	10	003055
00050033783	1	43	18,0	35,0	28,0	135	10	003062
00050033883	1.1/16	43	18,0	36,5	29,0	145	10	003079
00050033983	1.1/8	43	18,0	38,8	31,0	165	10	003086
00050034083	1.3/16	43	18,0	40,3	29,0	170	10	003093
00050034183	1.1/4	43	18,0	42,4	29,0	175	10	003109

50-19

DIN 3124 / ISO 2725



Steckschlüssel-Einsätze, extra lang

Chrom-Vanadium, CP = verchromt, teilweise poliert mit Kugelfangrinne

Sockets, extra deep

Chrome-Vanadium, CP = chromium plated, head polished with ball retaining groove

Douilles, extra longues

Chrom-Vanadium, CP = chromées, partiellement polies avec gorge de verrouillage pour bille

Llaves de vaso, extra largo

Cromo Vanadio, CP = cromado, cabeza pulida espejo con ranura de retención por bola

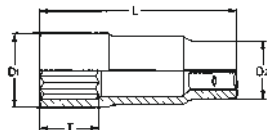

Code	MM	←L→ mm	T mm	D ₁ mm	D ₂ mm	g		EAN
00050191082	10	80	13,0	15,2	23,0	105	10	099874
00050191182	11	80	14,0	16,3	23,0	110	10	099881
00050191282	12	80	15,5	17,8	23,0	115	10	003451
00050191382	13	80	12,0	18,9	23,0	125	10	003468
00050191482	14	80	15,0	20,2	23,0	130	10	003475
00050191582	15	80	16,0	21,5	23,0	150	10	003482
00050191682	16	80	16,0	22,8	23,5	160	10	003499
00050191782	17	80	15,0	24,0	23,0	135	10	003505
00050191882	18	80	24,5	24,5	23,5	120	10	003512
00050191982	19	80	15,0	26,6	23,5	140	10	003529
00050192182	21	80	18,0	29,1	23,5	165	10	003536
00050192282	22	80	23,0	30,5	23,5	175	10	003543
00050192482	24	80	24,0	32,9	24,3	200	10	003550
00050192682	26	80	24,0	35,2	25,8	240	10	003567
00050192782	27	80	27,0	36,8	26,3	240	10	003574
00050193082	30	80	32,0	40,0	27,0	265	10	003581
00050193282	32	80	32,0	43,0	29,0	290	10	003598

Code	AF	←L→ mm	T mm	D ₁ mm	D ₂ mm	g		EAN
00050195282*	9/16	80	15,0	20,2	23,0	135	10	003611
00050195782*	15/16	80	24,0	32,9	24,3	200	10	003666

50-19-1 - 50-19-3

~ DIN 3124 / ISO 2725



Zündkerzen-Einsätze, extra lang

Chrom-Vanadium, CP = verchromt, teilweise poliert mit Kugelfangbohrung, mit Gummieinsatz

Spark plug sockets, extra deep

Chrome-Vanadium, CP = chromium plated, polished head, with ball retaining groove, with rubber insert

Douilles pour bougies, extra longues

Chrom-Vanadium, CP = chromées, partiellement polies avec gorge de verrouillage pour bille, avec bague de caoutchouc de retenue de la bougie

Llaves de vaso, para bujías, extra largo

CP = cromado, cabeza pulida espejo con ranura de retención por bola, con injerto de goma para bujías

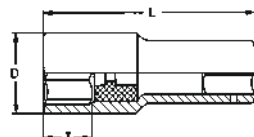

Code	No.	MM	AF	←L→ mm	T mm	D mm	g		EAN
00050190182	50-19-1	20,8	13/16	80	10,0	27,0	140	10	003413
00050190382	50-19-3	16	5/8	80	8,5	22,0	125	10	003444

50-20

Steckschlüssel-Einsätze

Chrom-Vanadium, CPP = verchromt, ganz poliert mit Kugelfangrinne, für Außen-TORX®-Schrauben

Sockets

Chrome-Vanadium, CPP = chromium plated, fully polished, with ball retaining groove, for TORX®-head screws

Douilles

Chrome-Vanadium, CPP = chromées, entièrement polies avec gorge de verrouillage pour bille, pour vis TORX®-extérieures

Llaves de vaso

Cromo Vanadio, CPP = cromado, cabeza pulida espejo con ranura de retención por bola, para tornillos TORX® exteriores

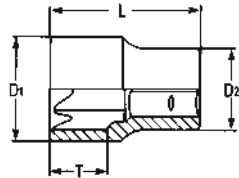

Code	Größe size	mm	L mm	T mm	D ₁ mm	D ₂ mm	g	g	EAN
00050201083	E 10	9,42	36	6,4	13,2	21,0	45	10	003697
00050201183	E 11	10,08	37	7,2	13,7	21,0	46	10	003703
00050201283	E 12	11,17	37	8,0	15,0	21,0	47	10	003710
00050201483	E 14	12,90	37	8,8	16,3	21,0	49	10	003727
00050201683	E 16	14,76	37	9,6	18,8	22,0	57	10	003734
00050201883	E 18	16,70	37	11,1	20,4	22,0	57	10	003741
00050202083	E 20	18,49	37	12,7	22,9	22,0	62	10	003758
00050202483	E 24	22,16	40	15,9	26,8	26,0	100	10	003765

50-30 - 50-36

Schraubendreher-Einsätze

Körper: Chrom-Vanadium, CPP = verchromt, ganz poliert mit Kugelfangrinne

Bits: Sonderstahl, PH = phosphatiert

Screwdriver sockets

Socket bodies: Chrome-Vanadium, CPP = chromium plated, fully polished, with ball retaining groove

Bits: Special steel, PH = phosphated

Douilles tournevis

Douilles: Chrome-Vanadium, CPP = chromées, entièrement polies avec gorge de verrouillage pour bille

Embout: Acier Spécial, PH = phosphaté

Llaves de vaso con destornillador

Cuerpo: Cromo Vanadio, CPP = cromado, enteramente pulido espejo con ranura de retención por bola

Puntas: Acero aleado, PH = fosfatado



50-30 für Schlitz-Schrauben/for plain slot screws

Code	mm	mm	L ₁ mm	L ₂ mm	D ₁ mm	D ₂ mm	g	g	EAN
00050300183	8	1,2	62	22	22,5	16,0	71	10	003789
00050300283	8	1,6	62	22	22,5	18,0	77	10	003796
00050300383	10	1,6	62	22	22,5	20,0	87	10	003802
00050300483	12	2,0	62	22	22,5	25,0	115	10	003819
00050300583	14	2,5	62	22	24,0	28,0	141	10	003826

50-31 für Innensechskant-Schrauben/for hexagon socket screws, DIN 7422/ISO 1174

Code	MM	L ₁ mm	L ₂ mm	D ₁ mm	D ₂ mm	g	g	EAN
00050310183	4	52	12	22,5	15,0	67	10	003833
00050310283	5	52	12	22,5	15,0	67	10	003840
00050312183	5	120	80	22,5	16,0	80	10	396959
00050311483	5	180	140	22,5	15,0	96	10	003963
00050310383	6	52	12	22,5	15,0	68	10	003857
00050312283	6	120	80	22,5	16,0	100	10	396966
00050311583	6	137	97	22,5	15,0	87	10	003970
00050311683	6	160	120	22,5	15,0	93	10	003987
00050311783	7	52	12	22,5	15,0	69	10	003994
00050311383	7	100	60	22,5	15,0	89	10	003956
00050312383	7	120	80	22,5	16,0	100	10	396973
00050310483	8	52	12	22,5	15,0	70	10	003864
00050311083	8	100	60	22,5	15,0	90	10	003925
00050311283	8	120	80	22,5	15,0	99	10	003949
00050312083	9	52	12	22,5	18,0	80	10	395655
00050310583	10	52	12	22,5	17,0	79	10	003871
00050312483	10	120	80	22,5	18,0	120	10	396980
00050311183	10	140	100	22,5	17,0	140	10	003932
00050310683	12	52	12	22,5	20,0	90	10	003888
00050312583	12	120	80	22,5	20	140	10	396997
00050311883	12	140	100	22,5	20,0	170	10	099898
00050310783	14	52	12	22,5	24,5	115	10	003895
00050312683	14	120	80	22,5	25	200	10	397000
00050311983	14	140	100	22,5	24,5	200	10	099904
00050310883	17	60	20	24,0	27,5	163	10	003901
00050310983	19	60	20	24,0	30,0	188	10	003918



50-30



50-31



50-32



50-33



50-34



50-35



50-36

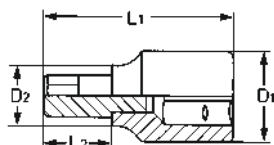

50-30 - 50-36

Schraubendreher-Einsätze

Körper: Chrom-Vanadium, CPP = verchromt, ganz poliert mit Kugelfangrinne

Bits: Sonderstahl, PH = phosphatiert

Screwdriver sockets

Socket bodies: Chrome-Vanadium, CPP = chromium plated, fully polished, with ball retaining groove

Bits: Special steel, PH = phosphated

Douilles tournevis

Douilles: Chrome-Vanadium, CPP = chromées, entièrement polies avec gorge de verrouillage pour bille

Embout: Acier Spécial, PH = phosphaté

Llaves de vaso con destornillador

Cuerpo: Cromo Vanadio, CPP = cromado, enteramente pulido espejo, con ranura de retención por bola

Puntas: Acero aleado, PH = fosfatado



50-30



50-31



50-32



50-33



50-34



50-35



50-36

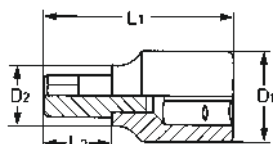

50-31 für Innensechskant-Schrauben/for hexagon socket screws, DIN 7422/ISO 1174

Code	AF	L ₁ mm	L ₂ mm	D ₁ mm	D ₂ mm	g	g	EAN
00050313283	3/16	52	12	22,5	16,0	68	10	004007
00050313483	1/4	52	12	22,5	16,0	70	10	004014
00050313683	5/16	52	12	22,5	16,0	70	10	004021
00050313883	3/8	52	12	22,5	18,0	80	10	004038
00050314083	7/16	52	12	22,5	20,0	85	10	004045
00050314283	1/2	52	12	22,5	25,0	115	10	004052
00050314483	9/16	60	20	24,0	28,0	150	10	004069
00050315083	3/4	60	20	24,0	30,0	185	10	004076

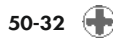

50-32 für Kreuzschlitz-Schrauben/for cross slot screws PHILLIPS-RECESS

Code	No.	L ₁ mm	L ₂ mm	D ₁ mm	D ₂ mm	g	g	EAN
00050320283	2	56	16	22,5	16,0	70	10	004083
00050320383	3	56	16	22,5	16,0	70	10	004090
00050320483	4	56	16	22,5	18,0	75	10	004106

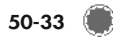

50-33 für Innenvielzahn-Schrauben/for multi-spline socket screws XZN

Code	für Schrauben for screws	L ₁ mm	L ₂ mm	D ₁ mm	D ₂ mm	g	g	EAN
00050330183	M 5	52	12	22,5	16,0	70	10	004113
00050330283	M 6	52	12	22,5	16,0	70	10	004120
00050330383	M 8	53	13	22,5	16,0	70	10	004137
00050330483	M 8	100	60	22,5	16,0	90	10	004144
00050330583	M 10	53	13	22,5	18,0	80	10	004151
00050330683	M 10	120	80	22,5	18,0	120	10	004168
00050330783	M 12	55	15	22,5	20,0	90	10	004175
00050330883	M 12	100	60	22,5	20,0	130	10	004182
00050331183	M 12	140	100	22,5	20,0	170	10	004212
00050330983	M 14	58	18	22,5	25,0	115	10	004199
00050331083	M 16	60	20	24,0	28,0	150	10	004205

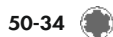

50-34 für Innenkeilprofil-Schrauben/for fluted socket screws RIBE CV

Code	für Schrauben for screws	L ₁ mm	L ₂ mm	D ₁ mm	D ₂ mm	g	g	EAN
00050340183	M 5	63	23	22,5	16,0	68	10	004229
00050340283	M 6	63	23	22,5	16,0	70	10	004236
00050340383	M 8	63	23	22,5	16,0	70	10	004243
00050340483	M 10	63	23	22,5	18,0	78	10	004250
00050340583	M 12	63	23	22,5	20,0	93	10	004267
00050340683	M 14	63	23	22,5	25,0	120	10	004274
00050340783	M 16	63	23	24,0	28,0	152	10	004281

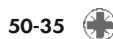

50-35 für Kreuzschlitz-Schrauben/for cross slot screws POZIDRIV®

Code	No.	L ₁ mm	L ₂ mm	D ₁ mm	D ₂ mm	g	g	EAN
00050350283	2	56	16	22,5	16,0	70	10	004298
00050350383	3	56	16	22,5	16,0	70	10	004304



50-36 für Innen-TORX®-Schrauben/for TORX®-socket screws

Code	Größe size	mm	L ₁ mm	L ₂ mm	D ₁ mm	D ₂ mm	g	g	EAN
00050362083	T 20	3,86	55	15	22,5	16,0	65	10	004328
00050362583	T 25	4,43	55	15	22,5	16,0	65	10	004335
00050362783	T 27	4,99	55	15	22,5	16,0	67	10	004342
00050363083	T 30	5,52	55	15	22,5	16,0	68	10	004359
00050364083	T 40	6,65	55	15	22,5	16,0	70	10	004366
00050364183	T 40	6,65	120	80	22,5	16,0	100	10	099911
00050364583	T 45	7,82	55	15	22,5	16,0	72	10	004373
00050364683	T 45	7,82	120	80	22,5	16,0	110	10	099928
00050365083	T 50	8,83	58	18	22,5	18,0	80	10	004380
00050365183	T 50	8,83	140	100	22,5	18,0	120	10	099935
00050365583	T 55	11,22	58	18	22,5	25,0	110	10	004397
00050365683	T 55	11,22	140	100	22,5	25,0	170	10	099942
00050366083	T 60	13,25	58	18	22,5	25,0	115	10	004403



50-50



Satz mit Schraubendreher- und Steckschlüssel-Einsätzen

Chrom-Vanadium, CPP = verchromt, ganz poliert
Metallkasten 225 x 115 x 38 mm

Combined set of sockets and screwdriver sockets

Chrome-Vanadium, CPP = chromium plated, fully polished
Metal case 225 x 115 x 38 mm

Compositions de douilles et de douilles-tournevis

Chrom-Vanadium, CPP = chromées, entièrement polies
Coffret métallique 225 x 115 x 38 mm

Juegos de llaves de vaso con destornillador

Cromo Vanadio, CPP = cromado, enteramente pulido espejo
Caja metálica 225 x 115 x 38 mm



für TORX®-Schrauben/for TORX®-screws

Code	No.	tlg./pcs.			EAN
00050500083	50-50-E/T	16	1550	1	004410

enthaltend/containing

Stck./pcs.	Artikel/article	No.	Maße/dimensions
je 1 each		50-20	E 10 E 11 E 12 E 14 E 16 E 18 E 20 E 24
je 1 each		50-36	T 25 T 27 T 30 T 40 T 45 T 50 T 55 T 60

50-55-2 - 50-58



Sätze mit Schraubendreher-Einsätzen

Chrom-Vanadium, CPP = verchromt, ganz poliert
Metallkasten 225 x 115 x 38 mm

Sets with screwdriver sockets

Chrome-Vanadium, CPP = chromium plated, fully polished
Metal case 225 x 115 x 38 mm

Jeux de douilles tournevis

Chrom-Vanadium, CPP = chromées, entièrement polies
Coffret métallique 225 x 115 x 38 mm

Juegos de llaves de vaso con destornillador

Cromo Vanadio, CPP = cromado, enteramente pulido espejo
Caja metálica 225 x 115 x 38 mm



für Innensechskant-Schrauben/for hexagon socket screws

Code	No.	tlg./pcs.			EAN
00050550283	50-55-2-M	8	1200	1	004434

enthaltend/containing

Stck./pcs.	Artikel/article	No.	Maße/dimensions
8		50-31	MM 5 x 52 6 x 52 7 x 52 8 x 52 10 x 52 12 x 52 14 x 52 17 x 52

für Innen-TORX®-Schrauben/for TORX®-socket screws

Code	No.	tlg./pcs.			EAN
00050580083	50-58	8	1120	1	004472

enthaltend/containing

Stck./pcs.	Artikel/article	No.	Maße/dimensions
8		50-36	T 25 T 27 T 30 T 40 T 45 T 50 T 55 T 60





50-78 - 50-79



Steckschlüssel-Einsätze auf Aluminium-Klemmleiste, 16-tlg.

Aluminium-Klemmleiste grün eloxiert.
Chrom-Vanadium, CPP = verchromt, ganz poliert mit Kugelfangrinne

Sockets on aluminium socket rail, 16 pcs.

Aluminium socket rail, anodized.
Chrome-Vanadium, CPP = chromium plated, fully polished with ball retaining groove

Assortiment douilles sur bande alu, 16 pcs.

Bloc aluminium anodisé.
Chrom-Vanadium, CPP = chromées, entièrement polies avec gorge de verrouillage pour bille

Juego de 16 llaves de vaso en regla de sujeción de aluminio

Regla de sujeción, de aluminio anodizado color verde.
Cromo Vanadio, CPP = cromado, cabeza pulida espejo con ranura de retención por bolae

Code	No.	tlg./pcs.			EAN
00050780083	50-78-M	16	1841	1	366693

enthaltend/containing

Stck./pcs.	Artikel/article	No.	Maße/dimensions
16		50-6-M	MM 10 11 12 13 14 15 16 17 18 19 21 22 24 27 30 32

Code	No.	tlg./pcs.			EAN
00050790083	50-79-M	16	1716	1	366709

enthaltend/containing

Stck./pcs.	Artikel/article	No.	Maße/dimensions
16		50-12-M	MM 10 11 12 13 14 15 16 17 18 19 21 22 24 27 30 32

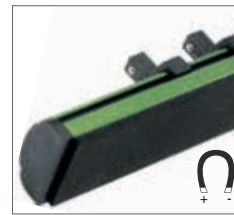

987-50



Aluminium-Klemmleiste, leer

zur Aufnahme von max. 16 Einsätzen
Kugelgefederter Aufnahme gewährleistet perfekten Halt der Einsätze.
Sicherer Halt der Klemmleiste durch Magnet an Metallflächen.

Aluminium socket rail, empty

for max. 16 sockets
Spring-loaded retaining ball ensures a perfect hold of the sockets. A strong magnet securely holds the socket rail to ferrous metal.

Bornes en aluminium, vide

pour max. 16 inserts
Les billes à ressort assurent une parfaite prise en main.
Blocage des bornes dues aux aimants et les surfaces métalliques.

Regla de aluminio anodizado color verde

para sujeción de 16 llaves de vaso.
Sujeción con muelle, garantiza una firme colocación de los vasos.
Regla sujeta por imán.

Code	No.	tlg./pcs.			EAN
98710501600	987-50	1	301	1	365290

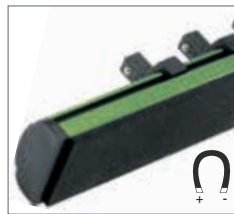
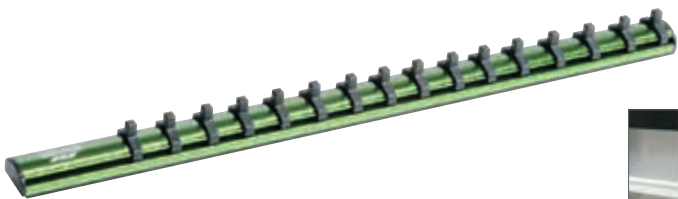

50-65 - 50-77

Kombi-Spender mit Steckschlüssel- und Schraubendreher-Einsätzen

aus Stahlblech, zum Aufstellen und Hängen; problemlos Bestücken beider Schütten durch herausnehmbares Oberteil; variable Einteilung durch Trennleistensystem, daher Zusammenstellung von Sortimenten nach Wahl möglich; aufschiebbarer Zusatzschale mit Hartschaumeinlage zum senkrechten Einstecken von Schraubendreher-Einsätzen extra lang. Folgende Sortimente führen wir standardmäßig:

Dispensers containing sockets and screwdriver sockets

sheet steel, for counter-display and wall mounting; simple re-filling of both dispenser units with removable upper tray; variable system of partitions permits composition of different assortments to choice; additional slide-on tray with hard foam insert for vertical presentation of screwdriver sockets, converters etc. The following assortments represent our standard range:

Présentoirs combinés avec douilles et douilles-tournevis

en tôle d'acier, pour présentation sur comptoir ou montage mural; remplissage facile des deux glissières grâce à la partie supérieure démontable; un système variable de cloisonnement permet des compositions différentes au choix; le plateau additionnel enfilaible avec insert troué de mousse rigide permet l'insertion verticale des douilles tournevis, augmentateurs/réducteurs, etc. Les compositions suivantes sont standardisées:

Expositor combinado de llaves de vaso y vasos con destornillador

de chapa de acero, de sobremesa o para colgar, ambos cargadores facilmente recargables, gracias a la parte superior desmontable; separaciones ajustables por sistema de listones que permiten componer los surtidos a elección del usuario, suplemento acoplable con cama de espuma de polietileno, para la colocación vertical de llaves de vaso con destornillador reductores/amplidores. Los siguientes surtidos son standard:



Code	No.	tlg./pcs.	g	g	EAN
00050650083	50-65-M	325	40098	1	004779
317 Schraubendreher-Einsätze/screwdriver sockets, 8 Verbindungsstücke/converters enthaltend/containing					
Stck. pcs.	Artikel/article	No.	Maße/dimensions		
4		40-15	35 mm		
4		50-14-1	38 mm		
je 10 each		50-30	8 x 1,2 8 x 1,6 10 x 1,6 12 x 2,0 14 x 2,5 mm		
je 9 each		50-31	MM 4 x 52 5 x 52		
4		50-31	MM 5 x 180		
9		50-31	MM 6 x 52		
je 4 each		50-31	MM 6 x 137 6 x 160 7 x 100		
9		50-31	MM 8 x 52		
8		50-31	MM 8 x 100		
4		50-31	MM 8 x 120		
9		50-31	MM 10 x 52		
8		50-31	MM 10 x 140		
je 9 each		50-31	MM 12 x 52 14 x 52 17 x 60 19 x 60		
je 10 each		50-32	PH No. 2 3		
je 10 each		50-33	M 6 x 52 8 x 53		
4		50-33	M 8 x 100		
10		50-33	M 10 x 53		
4		50-33	M 10 x 120		
10		50-33	M 12 x 55		
je 4 each	50-33	M 12 x 100 12 x 140			
je 10 each		50-35	PZ No. 2 3		
je 9 each		50-36	T20 T25 T30 T40 T45 T50		

Code	No.	tlg./pcs.	g	g	EAN
00050750083	50-75-M	258	32750	1	004854
198 Doppel-6-kant Steckschlüssel-Einsätze/bihexagon sockets MM, 52 Schraubendreher-Einsätze/screwdriver sockets, 8 Verbindungsstücke/converters enthaltend/containing					
Stck. pcs.	Artikel/article	No.	Maße/dimensions		
je 10 each		50-12	MM 8 9 10 11 12 13 14 15 16		
je 8 each		50-12	MM 17 18 19 20 21 22 23 24 25		
je 6 each		50-12	MM 26 27 28 29 30 32		
4		40-15	35 mm		
4		50-14-1	38 mm		
je 4 each		50-30	8 x 1,2 10 x 1,6 mm		
je 4 each		50-31	MM 4 x 52 5 x 52 6 x 52 8 x 52 10 x 52 12 x 52 14 x 52 17 x 60 19 x 60		
je 4 each		50-32	PH No. 2 3		

Code	No.	tlg./pcs.	g	g	EAN
00050760083	50-76-M	258	33550	1	004892
198 6-kant Steckschlüssel-Einsätze/hexagon sockets MM, 52 Schraubendreher-Einsätze/screwdriver sockets, 8 Verbindungsstücke/converters wie/as 50-75-M, jedoch/but					
Stck. pcs.	Artikel/article	No.	Maße/dimensions		
		50-6	Mengen und Maße siehe/quantities and dimensions see 50-75		

Code	No.	tlg./pcs.	g	g	EAN
00050770083	50-77-AF	266	32975	1	004922
206 Doppel-6-kant Steckschlüssel-Einsätze/bihexagon sockets AF, 52 Schraubendreher-Einsätze/screwdriver sockets, 8 Verbindungsstücke/converters enthaltend/containing					
Stck. pcs.	Artikel/article	No.	Maße/dimensions		
je 20 each		50-12	AF 3/8 7/16 1/2 9/16		
10		50-12	AF 19/32		
20		50-12	AF 5/8		
8		50-12	AF 11/16		
16		50-12	AF 3/4		
je 8 each		50-12	AF 25/32 13/16 7/8 15/16 31/32 1		
je 6 each	50-12	AF 1.1/16 1.1/8 1.3/16 1.1/4			
4		40-15	35 mm		
4		50-14-1	38 mm		
je 4 each		50-30	8 x 1,2 12 x 2,0 mm		
je 4 each		50-31	AF 3/16 1/4 5/16 3/8 52 mm		
8		50-31	AF 1/2 x 52 mm		
8		50-31	AF 9/16 x 60 mm		
4		50-31	AF 3/4 x 60 mm		
je 4 each		50-32	PH No. 2 3		



50-80 - 50-80-40

Kombi-Spender, leer und Zubehör

50-80 Kombi-Spender, leer, mit 2 Schütten
 50-80-10 Trennleiste für Kombi-Spender (untere Schütte)
 50-80-20 Trennleiste für Kombi-Spender (obere Schütte)
 50-80-30 Aufschiebbare Zusatzschale für Kombi-Spender
 50-80-40 Gelochte Hartschaum-Einlage für Zusatzschale 50-80-30
 L = lackiert, Z = verzinkt, ST = standardmäßig, (Hartschaum, schwarz)

Dispensers, empty and accessories

50-80 Dispenser, empty, with 2 trays
 50-80-10 Partitions for dispenser (lower tray)
 50-80-20 Partitions for dispenser (upper tray)
 50-80-30 Slide-on tray for dispenser
 50-80-40 Perforated hard foam insert for slide-on tray 50-80-30
 L = lacquered, Z = galvanized, ST = standard, (hard foam, black)

Présentoirs combinés, vides et accessoires

50-80 Présentoir combiné, vide, avec 2 glissières
 50-80-10 Cloisonnement pour présentoir combiné (glissière inférieure)
 50-80-20 Cloisonnement pour présentoir combiné (glissière supérieure)
 50-80-30 Plateau additionnel enfilaable sur présentoir combiné
 50-80-40 Insert troué de mousse rigide pour plateau additionnel 50-80-30
 L = laquées, Z = galvanisés, ST = standard, (mousse rigide noire)

Expositores combinados, vacíos y accesorios

50-80 Expositor combinado, vacío, con 2 cargadores
 50-80-10 Listón separador para expositor combinado (cargador inferior)
 50-80-20 Listón separador para expositor combinado (cargador superior)
 50-80-30 Suplemento acoplable para expositor combinado
 50-80-40 Cama de espuma de polietileno perforada para suplemento 50-80-30
 L = barnizado, Z = zincado, ST = standard, (espuma de polietileno, negro)



Benötigtes Zubehör-Sortiment für Kombi-Spender/required accessories for dispenser:

Code	No.	für Kombi-Spender for dispenser			bestehend aus consisting of Stck. No.		EAN
00050800100	50-80-1	40-75	40-76		1	50-80	004984
					16	50-80-10	
					18	50-80-20	
00050800200	50-80-2	40-85	40-88		1	50-80	004991
					16	50-80-10	
					16	50-80-20	
00050800300	50-80-3	50-65			1	50-80	005004
					13	50-80-10	
					13	50-80-20	
					1	50-80-30	
					1	50-80-40	
00050800400	50-80-4	50-75	50-76	50-77	1	50-80	005011
					9	50-80-10	
					13	50-80-20	
					1	50-80-30	
					1	50-80-40	

Code	No.	Ausf. finish	Maße/dimensions mm	g		EAN
00050800020	50-80	L	470 x 320 x 234	8250	1	004977
00050801060	50-80-10	Z	289 x 20 x 1,5	65	10	005035
00050802060	50-80-20	Z	234 x 20 x 1,5	53	10	005042
00050803020	50-80-30	L	474 x 155 x 36	1300	1	005059
00050804000	50-80-40	ST	470 x 150 x 20	25	1	005066

50-85 - 50-87 / 50-95 - 50-97

Einsatzspender mit Steckschlüssel-Einsätzen

aus Stahlblech, zum Aufstellen und Hängen

Socket dispensers

sheet steel, for counter display and wall mounting

Présentoirs avec douilles

en tôle d'acier, pour présentation sur comptoir ou montage mural

Expositores de llaves de vaso

de chapa de acero, de sobremesa y para colgar

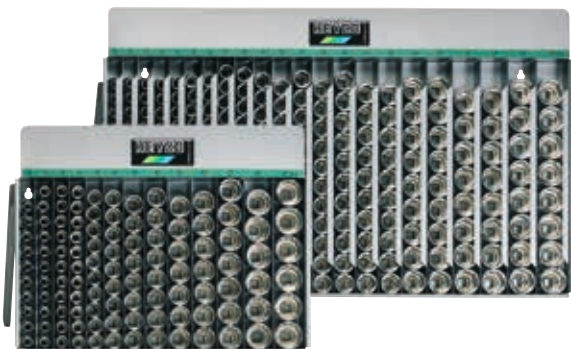

Code	No.	tlg./pcs.	g		EAN
00050850083	50-85-M	102	12100	1	005073

enthaltend/containing

Stck./pcs.	Artikel/article	No.	Maße/dimensions
je 10 each		50-12	MM 10 11 13 14
je 9 each		50-12	MM 17 19
8		50-12	MM 21
je 7 each		50-12	MM 22 24
je 6 each		50-12	MM 25 27
je 5 each		50-12	MM 30 32

Code	No.	tlg./pcs.	g		EAN
00050860083	50-86-M	102	12500	1	005080

wie/as 50-85-M, jedoch/but

Stck./pcs.	Artikel/article	No.	Maße/dimensions
		50-6	Mengen und Maße siehe/quantities and dimensions see 50-85-M

50-85 - 50-87 / 50-95 - 50-97

Einsatzspender mit Steckschlüssel-Einsätzen
aus Stahlblech, zum Aufstellen und Hängen

Socket dispensers
sheet steel, for counter display and wall mounting

Présentoirs avec douilles
en tôle d'acier, pour présentation sur comptoir ou montage mural

Expositores de llaves de vaso
de chapa de acero, de sobremesa y para colgar

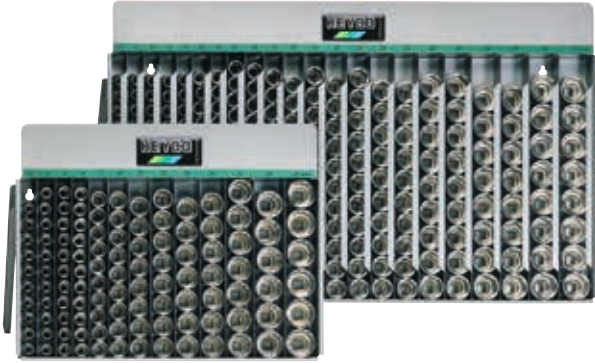

Code	No.	tlg./pcs.			EAN
00050870083	50-87-AF	109	12300	1	005097

enthaltend/containing

Stck./pcs.	Artikel/article	No.	Maße/dimensions
je 10 each		50-12	AF 3/8 7/16 1/2 9/16 5/8 11/16
9		50-12	AF 3/4
je 8 each		50-12	AF 13/16 7/8
7		50-12	AF 15/16
je 6 each		50-12	AF 1 1.1/8
5		50-12	AF 1.1/4

Code	No.	tlg./pcs.			EAN
00050950083	50-95-M	278	31400	1	005127

enthaltend/containing

Stck./pcs.	Artikel/article	No.	Maße/dimensions
je 16 each		50-12	MM 10 11 12 13 14 15 16
15		50-12	MM 17
14		50-12	MM 18
je 13 each		50-12	MM 19 20
je 12 each		50-12	MM 21 22
je 11 each		50-12	MM 23 24
je 10 each		50-12	MM 25 26 27
je 9 each		50-12	MM 28 29 30
8		50-12	MM 32

Code	No.	tlg./pcs.			EAN
00050960083	50-96-M	278	32500	1	005134

wie/as 50-95-M, jedoch/but

Stck./pcs.	Artikel/article	No.	Maße/dimensions
		50-6	Mengen und Maße siehe/quantities and dimensions see 50-95-M

Code	No.	tlg./pcs.			EAN
00050970083	50-97-AF	294	30800	1	005141

enthaltend/containing

Stck./pcs.	Artikel/article	No.	Maße/dimensions
je 32 each		50-12	AF 3/8 7/16 1/2
je 16 each		50-12	AF 9/16 19/32
32		50-12	AF 5/8
15		50-12	AF 11/16
je 13 each		50-12	AF 3/4 25/32 13/16
12		50-12	AF 7/8
je 11 each		50-12	AF 15/16 31/32
je 10 each		50-12	AF 1 1.1/16
je 9 each		50-12	AF 1.1/8 1.3/16
8		50-12	AF 1.1/4

50-90 - 50-100

Einsatzspender, leer
L = lackiert

Socket dispensers, empty
L = lacquered

Présentoirs, vides
L = laquées

Expositores vacíos
L = barnizado

Code	No.	für No.	Maße mm			EAN
00050900020	50-90	50-85 – 50-89	450 x 330 x 55	3250	1	005110
00050000120	50-100	50-95 – 50-99	745 x 455 x 55	6500	1	002317



2-67-50 – 2-67-80

Werkzeugsortiment Expert in der L-BOXX®, 77-tlg.

Chrom-Vanadium
CP = verchromt, teilweise poliert
Lieferbar mit Steckschlüssel-Einsätzen
6-Kt. oder 12-Kt.

Alles was Sie vor Ort brauchen: Unsere Werkzeugsortimente sind perfekt abgestimmt auf die Anforderungen mobilen Arbeitens. In Kombination mit der L-BOXX® schaffen wir Ordnung und Überblick von Anfang an. Die Schaumstoff-Module erlauben ein einfaches und sicheres Entnehmen der Werkzeuge. Dank ihrer robusten, spritzwassergeschützten Bauweise meistert die L-BOXX® aus schlag- und stoßfestem ABS-Kunststoff nahezu jede Herausforderung und hält auch extremen Belastungen stand. So ist sie für den täglichen Einsatz auf der Baustelle bestens gerüstet. Maße 442 x 357 x 151 mm

Tool set Expert in L-BOXX®, 77 pcs.

Chrome-Vanadium
CP = chromium plated, partly polished, available with sockets, 6-point (hex) or 12-point

Everything you need for the job at hand: Our tool sets are perfectly matched to the needs of mobile working scenarios. In combination with the L-BOXX®, we ensure order and an ideal overview as soon as you open the lid. The foam modules allow easy and safe access to all tools contained. Thanks to its robust and splashproof construction from shock and impact resistant ABS plastic, the L-BOXX® masters almost every challenge and stands up to even the most rugged situations. This makes it ideal for everyday use on construction sites.

Dimensions 442 x 357 x 151 mm

Assortiment d'outils Expert dans la L-BOXX®, 77 pcs.

Chrome vanadium
CP = chromé, partiellement poli
Disponible avec des embouts à clés 6 ou 12 pans
Tout ce dont vous avez besoin sur le terrain: nos assortiments d'outils sont parfaitement adaptés aux nécessités des personnels en intervention. En combinant les outils avec la L-BOXX®, nous vous garantissons de l'ordre et une parfaite vue d'ensemble dès le début. Les modules en mousse permettent de retirer les outils simplement et en toute sécurité. Grâce à sa conception solide protégeant des projections d'eau, la L-BOXX® en plastique ABS résistant aux chocs et aux impacts saura relever quasiment tous les défis et faire face aux plus hautes sollicitations. Elle est donc idéale pour une utilisation au quotidien sur les chantiers.

Dimensions 442 x 357 x 151 mm

Surtido de herramientas Expert en L-BOXX®, 77 piezas

Cromo vanadio
CP = cromado, parcialmente pulido
Disponible con insertos de llaves de tubo hexagonales o estrella
Todo lo que necesita a mano: nuestros surtidos de herramientas están perfectamente adaptados a las necesidades del trabajo móvil. En combinación con la L-BOXX® se logra desde el principio orden y una visión general. Los módulos de espuma permiten extraer las herramientas de forma sencilla y segura. Gracias a su composición sólida y resistente a salpicaduras, la L-BOXX® de plástico ABS resistente a deformación e impactos responde prácticamente a cualquier desafío y aguanta incluso cargas extremas. Está perfectamente preparada para el uso diario en construcción.

Dimensiones 442 x 357 x 151 mm

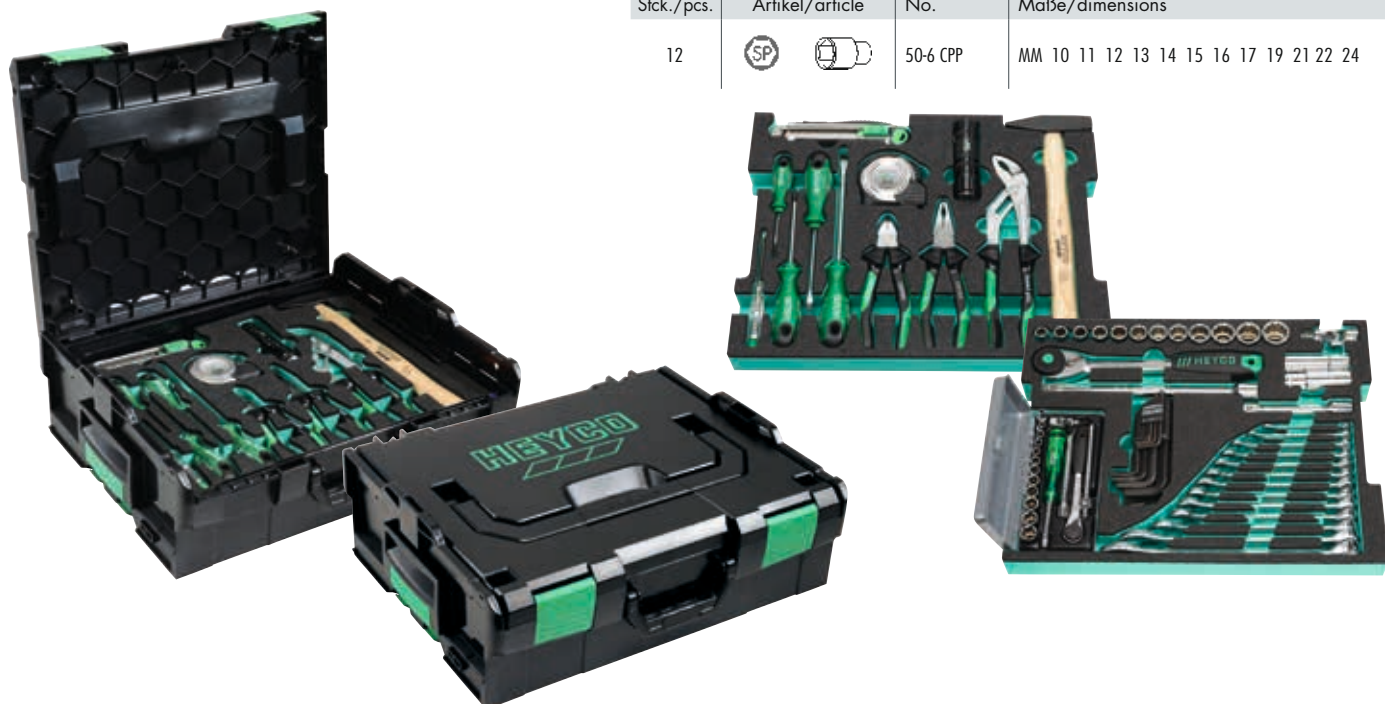

Code	No.	tlg./pcs.			EAN
00200675082	2-67-50-M	77	9910	1	416145

enthaltend/containing

Stck./pcs.	Artikel/article	No.	Maße/dimensions
12		50-12 CPP	MM 10 11 12 13 14 15 16 17 19 21 22 24
1		50-00-10	270 mm – 48 Zähne /teeth/dents/dientes
1		50-04 CPP	125 mm
1		50-05 CPP	250 mm
1		50-06 CPP	70 mm
2		50-19-1	20,8 mm / 5/8 AF
1		300 CPI	240 mm
13		400 CP	MM 6 8 10 11 12 13 14 15 16 17 19 22 24
1		1200 CPI	180 mm
1		1213 CPI	160 mm
8		1340 B	MM 2 2.5 3 4 5 6 8 10
8		1348 B	T 9 10 15 20 25 27 30 40
1		1424 N	3 x 65 mm
1		1520 LS	300 g
1		1664 ST	18 mm
1		1721 ST	110 mm, 1W
1		1840-5 ST	5 m
2		4511 C	PH No. 1 2
2		4530 C	5,5 x 100 mm 8,0 x 150 mm
12		25-6	MM 4 4,5 5 5,5 6 7 8 9 10 11 12 13
1		25-00-15	140 mm
1		25-03	115 mm
1		25-04	50 mm
1		25-05-1	150 mm
1		25-06	35 mm
1		25-08	145 mm

Code	No.	tlg./pcs.			EAN
00200678082	2-67-80-M	77	9610	1	416350

wie/as 2-67-50-M, jedoch/but

Stck./pcs.	Artikel/article	No.	Maße/dimensions
12		50-6 CPP	MM 10 11 12 13 14 15 16 17 19 21 22 24



2-67-5001 – 2-67-8001

Werkzeugsortiment für L-BOXX®, Modul 1, 65-tlg.

Chrom-Vanadium, CP = verchromt, teilweise poliert
12-Kt., MM-Größen
Maße 405 x 310 x 50 mm

Tool set for L-BOXX®, module 1, 65 pcs.

Chrome-Vanadium, CP = chromium plated, partly polished,
bihexagon, MM sizes. Dimensions 405 x 310 x 50 mm

Assortiment d'outils pour la L-BOXX®, module 1, 65 pièces

Chrome Vanadium, CP = chromé, partiellement poli,
12 pans, tailles en mm
Dimensions 405 x 310 x 50 mm

Surtido de herramientas para L-BOXX®, módulo 1, 65 pzs.

Cromo Vanadio, CP = cromado, pulido en parte, bihexagon,
dimensiones en mm
Dimensiones 405 x 310 x 50 mm

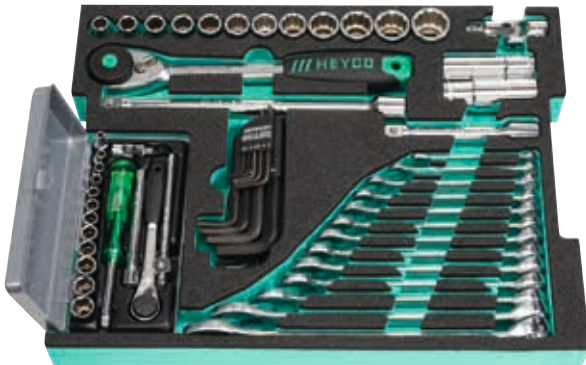

Code	No.	tlg./pcs.			EAN
00067500182	2-67-5001-M	65	5450	1	416305

enthaltend/containing

Stck./pcs.	Artikel/article	No.	Maße/dimensions
12		50-12 CPP	MM 10 11 12 13 14 15 16 17 19 21 22 24
1		50-00-10	270 mm – 48 Zähne/teeth/dents/dientes
1		50-04 CPP	125 mm
1		50-05 CPP	250 mm
1		50-06 CPP	70 mm
2		50-19-1	20,8 mm / 5/8 AF
13		400 CP	MM 6 8 10 11 12 13 14 15 16 17 19 22 24
8		1340 B	MM 2 2.5 3 4 5 6 8 10
8		1348 B	T 9 10 15 20 25 27 30 40
12		25-6	MM 4 4,5 5 5,5 6 7 8 9 10 11 12 13
1		25-00-15	140 mm
1		25-03	115 mm
1		25-04	50 mm
1		25-05-1	150 mm
1		25-06	35 mm
1		25-08	145 mm

Code	No.	tlg./pcs.			EAN
00067800182	2-67-8001-M	65	5120	1	416343

wie/as 2-67-5001-M, jedoch/but

Stck./pcs.	Artikel/article	No.	Maße/dimensions
12		50-6 CPP	MM 10 11 12 13 14 15 16 17 19 21 22 24

2-67-5002

Werkzeugsortiment für L-BOXX®, Modul 2, 12-tlg.

Maße 405 x 310 x 45 mm

Tool set for L-BOXX®, module 2, 12 pcs.

Dimensions 405 x 310 x 45 mm

Assortiment d'outils pour la L-BOXX®, module 2, 12 pièces

Dimensions 405 x 310 x 45 mm

Surtido de herramientas para L-BOXX®, módulo 2, 12 pzs.

Dimensiones 405 x 310 x 45 mm



Code	No.	tlg./pcs.			EAN
00067500282	2-67-5002-M	12	2560	1	416169

enthaltend/containing

Stck./pcs.	Artikel/article	No.	Maße/dimensions
1		300 CPI	240 mm
1		1200 CPI	180 mm
1		1213 CPI	160 mm
1		1424 N	3 x 65 mm
1		1520 LS	300 g
1		1664 ST	18 mm
1		1721 ST	110 mm, 1W
1		1840-5 ST	5 m
2		4511 C	PH No. 1 2
2		4530 C	5,5 x 100 mm 8,0 x 150 mm



57-0010

Steckschlüssel-Garnitur

Chrom-Vanadium, CPP = verchromt, ganz poliert
Metallkasten 407 x 162 x 53 mm

Socket set

Chrome-Vanadium, CPP = chromium plated, fully polished
Metal case 407 x 162 x 53 mm

Compositions de douilles

Chrome-Vanadium, CPP = chromées, entièrement polies
Coffret métallique 407 x 162 x 53 mm

Juegos de llaves de vaso

Cromo Vanadio, CPP = cromado, enteramente pulido espejo
Caja metálica 407 x 162 x 53 mm



für TORX®-Schrauben/for TORX®-screws

Code	No.	tlg./pcs.			EAN
00057001083	57-0010	20	3886	1	329667

enthaltend/containing

Stck./pcs.	Artikel/article	No.	Maße/dimensions
7		50-20	E 10 E 11 E 12 E 14 E 16 E 18 E 20 E 24
8		50-36	T 25 T 27 T 30 T 40 T 45 T 50 T 55 T 60
1		50-00-10	270 mm – 48 Zähne /teeth/dents/dientes
1		50-04	125 mm
1		50-06	70 mm



70-0 - 70-3010

Steckschlüssel-Garnituren

Chrom-Vanadium, CPP = verchromt, ganz poliert
Metallkasten 318 x 119 x 49 mm

Socket sets

Chrome-Vanadium, CPP = chromium plated, fully polished
Metal case 318 x 119 x 49 mm

Compositions de douilles

Chrome-Vanadium, CPP = chromées, entièrement polies
Coffret métallique 318 x 119 x 49 mm

Juegos de llaves de vaso

Cromo Vanadio, CPP = cromado, enteramente pulido espejo
Caja metálica 318 x 119 x 49 mm



Code	No.	tlg./pcs.			EAN
00070001083	70-0010-M	15	2795	1	100570

enthaltend/containing

Stck./pcs.	Artikel/article	No.	Maße/dimensions
12		50-12 CPP	MM 10 11 12 13 14 15 16 17 18 19 20 22
1		50-00-10	270 mm – 48 Zähne /teeth/dents/dientes
1		50-03 CPP	300 mm
1		50-05 CPP	250 mm



Code	No.	tlg./pcs.			EAN
00070000083	70-0-M	15	2715	1	005394

wie/as 70-0010-M, jedoch/but

Stck./pcs.	Artikel/article	No.	Maße/dimensions
1		50-00-7 CP	270 mm – 48 Zähne /teeth/dents/dientes

Code	No.	tlg./pcs.			EAN
00070500083	70-50-M	15	2710	1	005523

wie/as 70-0010-M, jedoch/but

Stck./pcs.	Artikel/article	No.	Maße/dimensions
1		50-00-1 CP	270 mm – 30 Zähne /teeth/dents/dientes

Code	No.	tlg./pcs.			EAN
00070301083	70-3010-M	15	2825	1	100778

wie/as 70-0010-M, jedoch/but

Stck./pcs.	Artikel/article	No.	Maße/dimensions
12		50-6 CPP	MM 10 11 12 13 14 15 16 17 18 19 20 22



70-0 - 70-3010

Steckschlüssel-Garnituren

Socket sets

Compositions de douilles

Juegos de llaves de vaso



Code	No.	tlg./pcs.			EAN
00070300083	70-30-M	15	2745	1	005509

wie/as 70-0010-M, jedoch/but

Stck./pcs.	Artikel/article	No.	Maße/dimensions
12		50-6 CPP	MM 10 11 12 13 14 15 16 17 18 19 20 22
1		50-00-7 CP	270 mm – 48 Zähne /teeth/dents/dientes

Code	No.	tlg./pcs.			EAN
00070800083	70-80-M	15	2740	1	005592

wie/as 70-0010-M, jedoch/but

Stck./pcs.	Artikel/article	No.	Maße/dimensions
12		50-6 CPP	MM 10 11 12 13 14 15 16 17 18 19 20 22
1		50-00-1 CP	270 mm – 30 Zähne /teeth/dents/dientes

Code	No.	tlg./pcs.			EAN
00070101083	70-1010-AF	15	2855	1	100594

wie/as 70-0010-M, jedoch/but

Stck./pcs.	Artikel/article	No.	Maße/dimensions
12		50-12 CPP	AF 3/8 7/16 1/2 9/16 19/32 5/8 11/16 3/4 25/32 13/16 7/8 15/16

73-03 - 73-3310

Steckschlüssel-Garnituren

Chrom-Vanadium, CPP = verchromt, ganz poliert
Metallkasten 450 x 187 x 52 mm

Socket sets

Chrome-Vanadium, CPP = chromium plated, fully polished
Metal case 450 x 187 x 52 mm

Compositions de douilles

Chrome-Vanadium, CPP = chromées, entièrement polies
Coffret métallique 450 x 187 x 52 mm

Juegos de llaves de vaso

Cromo Vanadio, CPP = cromado, enteramente pulido espejo
Caja metálica 450 x 187 x 52 mm



Code	No.	tlg./pcs.			EAN
00073030083	73-03-M	23	4850	1	005677

enthaltend/containing

Stck./pcs.	Artikel/article	No.	Maße/dimensions
18		50-12 CPP	MM 10 11 12 13 14 15 16 17 18 19 20 21 22 23 24 27 30 32
1		50-00-7 CPP	270 mm – 48 Zähne /teeth/dents/dientes
1		50-03 CPP	300 mm
1		50-04 CPP	125 mm
1		50-05 CPP	250 mm
1		50-06 CPP	80 mm

Code	No.	tlg./pcs.			EAN
00073330083	73-33-M	23	5130	1	304664

wie/as 73-03-M, jedoch/but

Stck./pcs.	Artikel/article	No.	Maße/dimensions
18		50-6 CPP	MM 10 11 12 13 14 15 16 17 18 19 20 21 22 24 27 30 32
1		50-00-7 CP	270 mm – 48 Zähne /teeth/dents/dientes

Code	No.	tlg./pcs.			EAN
00073031083	73-0310-M	23	5215	1	329827

wie/as 73-03-M, jedoch/but

Stck./pcs.	Artikel/article	No.	Maße/dimensions
18		50-12 CPP	MM 10 11 12 13 14 15 16 17 18 19 20 21 22 23 24 27 30 32
1		50-00-10	270 mm – 48 Zähne /teeth/dents/dientes

Code	No.	tlg./pcs.			EAN
00073331083	73-3310-M	23	5360	1	329810

wie/as 73-03-M, jedoch/but

Stck./pcs.	Artikel/article	No.	Maße/dimensions
18		50-6 CPP	MM 10 11 12 13 14 15 16 17 18 19 20 21 22 23 24 27 30 32
1		50-00-10	270 mm – 48 Zähne /teeth/dents/dientes



75-0 - 75-3010

Steckschlüssel-Garnituren

Chrom-Vanadium, CPP = verchromt, ganz poliert
Metallkasten 450 x 187 x 52 mm

Socket sets

Chrome-Vanadium, CPP = chromium plated, fully polished
Metal case 450 x 187 x 52 mm

Compositions de douilles

Chrome-Vanadium, CPP = chromées, entièrement polies
Coffret métallique 450 x 187 x 52 mm

Juegos de llaves de vaso

Cromo Vanadio, CPP = cromado, enteramente pulido espejo
Caja metálica 450 x 187 x 52 mm



Code	No.	tlg./pcs.			EAN
00075001083	75-0010-M	24	5450	1	100617

enthaltend/containing

Stck./pcs.	Artikel/article	No.	Maße/dimensions
18		50-12 CPP	MM 12 13 14 15 16 17 18 19 20 21 22 23 24 26 27 28 30 32
1		50-00-10	270 mm – 48 Zähne /teeth/dents/dientes
1		50-02 CPP	405 mm
1		50-03 CPP	300 mm
1		50-04 CPP	125 mm
1		50-05 CPP	250 mm
1		50-06 CPP	80 mm

Code	No.	tlg./pcs.			EAN
00075000083	75-0-M	24	5360	1	005691

wie/as 75-0010-M, jedoch/but

Stck./pcs.	Artikel/article	No.	Maße/dimensions
1		50-00-7 CP	270 mm – 48 Zähne /teeth/dents/dientes

Code	No.	tlg./pcs.			EAN
00075500083	75-50-M	24	5355	1	005882

wie/as 75-0010-M, jedoch/but

Stck./pcs.	Artikel/article	No.	Maße/dimensions
1		50-00-1 CP	270 mm – 30 Zähne /teeth/dents/dientes

Code	No.	tlg./pcs.			EAN
00075301083	75-3010-M	24	5520	1	100679

wie/as 75-0010-M, jedoch/but

Stck./pcs.	Artikel/article	No.	Maße/dimensions
18		50-6 CPP	MM 12 13 14 15 16 17 18 19 20 21 22 23 24 26 27 28 30 32

Code	No.	tlg./pcs.			EAN
00075300083	75-30-M	24	5430	1	005851

wie/as 75-0010-M, jedoch/but

Stck./pcs.	Artikel/article	No.	Maße/dimensions
18		50-6 CPP	MM 12 13 14 15 16 17 18 19 20 21 22 23 24 26 27 28 30 32
1		50-00-7 CP	270 mm – 48 Zähne /teeth/dents/dientes

Code	No.	tlg./pcs.			EAN
00075800083	75-80-M	24	5425	1	005943

wie/as 75-0010-M, jedoch/but

Stck./pcs.	Artikel/article	No.	Maße/dimensions
18		50-6 CPP	MM 12 13 14 15 16 17 18 19 20 21 22 23 24 26 27 28 30 32
1		50-00-1 CP	270 mm – 30 Zähne /teeth/dents/dientes



75-0 75-3010

Steckschlüssel-Garnituren

Socket sets

Compositions de douilles

Juegos de llaves de vaso



Code	No.	tlg./pcs.			EAN
00075101083	75-1010-AF	24	5460	1	100655
wie/as 75-0010-M, jedoch/but					
Stck./pcs.	Artikel/article	No.	Maße/dimensions		
18		50-12 CPP	AF 3/8 7/16 1/2 9/16 19/32 5/8 11/16 3/4 25/32 13/16 7/8 15/16 31/32 1 1.1/16 1.1/8 1.3/16 1.1/4		

Code	No.	tlg./pcs.			EAN
00075100083	75-10-AF	24	5375	1	005745
wie/as 75-0010-M, jedoch/but					
Stck./pcs.	Artikel/article	No.	Maße/dimensions		
18		50-12 CPP	AF 3/8 7/16 1/2 9/16 19/32 5/8 11/16 3/4 25/32 13/16 7/8 15/16 31/32 1 1.1/16 1.1/8 1.3/16 1.1/4		
1		50-00-7 CP	270 mm – 48 Zähne /teeth/dents/dientes		

Code	No.	tlg./pcs.			EAN
00075600083	75-60-AF	24	5370	1	005929
wie/as 75-0010-M, jedoch/but					
Stck./pcs.	Artikel/article	No.	Maße/dimensions		
18		50-12 CPP	AF 3/8 7/16 1/2 9/16 19/32 5/8 11/16 3/4 25/32 13/16 7/8 15/16 31/32 1 1.1/16 1.1/8 1.3/16 1.1/4		
1		50-00-1 CP	270 mm – 30 Zähne /teeth/dents/dientes		

75-0110 - 75-3110

Steckschlüssel-Garnituren

Chrom-Vanadium, CPP = verchromt, ganz poliert
Metallkasten 450 x 187 x 52 mm

Socket sets

Chrome-Vanadium, CPP = chromium plated, fully polished
Metal case 450 x 187 x 52 mm

Compositions de douilles

Chrome-Vanadium, CPP = chromées, entièrement polies
Coffret métallique 450 x 187 x 52 mm

Juegos de llaves de vaso

Cromo Vanadio, CPP = cromado, enteramente pulido espejo
Caja metálica 450 x 187 x 52 mm



Code	No.	tlg./pcs.			EAN
00075011083	75-0110-M	26	5550	1	100624
enthaltend/containing					
Stck./pcs.	Artikel/article	No.	Maße/dimensions		
20		50-12 CPP	MM 10 11 12 13 14 15 16 17 18 19 20 21 22 23 24 26 27 28 30 32		
1		50-02 CPP	405 mm		
1		50-00-10	270 mm – 48 Zähne /teeth/dents/dientes		
1		50-03 CPP	300 mm		
1		50-04 CPP	125 mm		
1		50-05 CPP	250 mm		
1		50-06 CPP	80 mm		

Code	No.	tlg./pcs.			EAN
00075311083	75-3110-M	26	5650	1	100686
wie/as 75-0110-M, jedoch/but					
Stck./pcs.	Artikel/article	No.	Maße/dimensions		
20		50-6 CPP	MM 10 11 12 13 14 15 16 17 18 19 20 21 22 23 24 26 27 28 30 32		



1/2

75-0310 - 75-3310

Steckschlüssel-Garnituren

Chrom-Vanadium, CPP = verchromt, ganz poliert
Metallkasten 450 x 187 x 52 mm

Socket sets

Chrome-Vanadium, CPP = chromium plated, fully polished
Metal case 450 x 187 x 52 mm

Compositions de douilles

Chrome-Vanadium, CPP = chromées, entièrement polies
Coffret métallique 450 x 187 x 52 mm

Juegos de llaves de vaso









Cromo Vanadio, CPP = cromado, enteramente pulido espejo
Caja metálica 450 x 187 x 52 mm

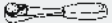

1/2



Code	No.	tlg./pcs.	g		EAN
00075031083	75-0310-M	23	5500	1	100631

enthaltend/containing

Stck./pcs.	Artikel/article	No.	Maße/dimensions
17	 	50-12 CPP	MM 10 11 12 13 14 15 16 17 18 19 21 22 24 27 30 32 34
1		50-00-10	270 mm – 48 Zähne /teeth/dents/dientes
1		50-03 CPP	300 mm
1		50-04 CPP	125 mm
1		50-04-1 CPP	75 mm
1		50-05 CPP	250 mm
1		50-06 CPP	80 mm

Code	No.	tlg./pcs.	g		EAN
00075331083	75-3310-M	23	5540	1	095357

wie/as 75-0310-M, jedoch/but

Stck./pcs.	Artikel/article	No.	Maße/dimensions
17	 	50-6 CPP	MM 10 11 12 13 14 15 16 17 18 19 21 22 24 27 30 32 34

76-0010

Steckschlüssel-Garnitur

Chrom-Vanadium, CPP = verchromt, ganz poliert
In hochwertiger 2-K Schaumstoffeinlage
Metallkasten 407 x 162 x 53 mm

Socket set

Chrome-Vanadium, CPP = chromium plated, fully polished
high quality 2-K-foam insert
Metal case 407 x 162 x 53 mm

Compositions de douilles

Chrome-Vanadium, CPP = chromées, entièrement polies
insert en mousse de haute qualité en 2 composants
Coffret métallique 407 x 162 x 53 mm

Juegos de llaves de vaso







Cromo Vanadio, CPP = cromado, enteramente pulido espejo
en bandeja de polispam de gran calidad
Caja metálica 407 x 162 x 53 mm

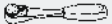

1/2

Code	No.	tlg./pcs.	g		EAN
00076001083	76-0010-M	20	4198	1	366495

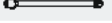
enthaltend/containing

Stck./pcs.	Artikel/article	No.	Maße/dimensions
16	 	50-12	MM 10 11 12 13 14 15 16 17 18 19 21 22 24 27 30 32
1		50-00-10	270 mm – 48 Zähne /teeth/dents/dientes
1		50-04	125 mm
1		50-05	250 mm
1		50-06	70 mm

77-0 - 77-30

Kombinierte Steckschlüssel- und Schraubendreher-Einsatz-Garnituren

Chrom-Vanadium, CPP = verchromt, ganz poliert
Metallkasten 450 x 187 x 52 mm

Combined socket- and screwdriver socket sets

Chrome-Vanadium, CPP = chromium plated, fully polished
Metal case 450 x 187 x 52 mm

Compositions de douilles et de douilles-tournevis

Chrome-Vanadium, CPP = chromées, entièrement polies
Coffret métallique 450 x 187 x 52 mm

Juegos combinados de llaves de vaso y llaves de vaso con destornillador

Cromo Vanadio, CPP = cromado, enteramente pulido espejo
Caja metálica 450 x 187 x 52 mm



Code	No.	tlg./pcs.			EAN
00077000083	77-0-M	36	5860	1	006025

enthaltend/containing

Stck./pcs.	Artikel/article	No.	Maße/dimensions
18		50-12 CPP	MM 12 13 14 15 16 17 18 19 20 21 22 23 24 26 27 28 30 32
1		50-00-7 CP	270 mm – 48 Zähne /teeth/dents/dientes
3		50-30 CPP	8 x 1,2 12 x 2,0 14 x 2,5 mm
7		50-31 CPP	MM 5 6 8 10 12 14 17
3		50-32 CPP	PH No. 2 3 4
1		50-03 CPP	300 mm
1		50-04 CPP	125 mm
1		50-05 CPP	250 mm
1		50-06 CPP	80 mm

Code	No.	tlg./pcs.			EAN
00077300083	77-30-M	36	5940	1	006056

wie/as 77-0-M, jedoch/but

Stck./pcs.	Artikel/article	No.	Maße/dimensions
18		50-6 CPP	MM 12 13 14 15 16 17 18 19 20 21 22 23 24 26 27 28 30 32

78-0 - 78-3010

Steckschlüssel-Garnituren

Chrom-Vanadium, CPP = verchromt, ganz poliert
Metallkasten 407 x 162 x 53 mm

Socket sets

Chrome-Vanadium, CPP = chromium plated, fully polished
Metal case 407 x 162 x 53 mm

Compositions de douilles

Chrome-Vanadium, CPP = chromées, entièrement polies
Coffret métallique 407 x 162 x 53 mm

Juegos de llaves de vaso

Cromo Vanadio, CPP = cromado, enteramente pulido espejo
Caja metálica 407 x 162 x 53 mm



Code	No.	tlg./pcs.			EAN
00078001083	78-0010-M	18	4820	1	100693

enthaltend/containing

Stck./pcs.	Artikel/article	No.	Maße/dimensions
13		50-12 CPP	MM 10 11 12 13 14 15 17 19 22 24 27 30 32
1		50-00-10	270 mm – 48 Zähne /teeth/dents/dientes
1		50-03 CPP	300 mm
1		50-04 CPP	125 mm
1		50-05 CPP	250 mm
1		50-06 CPP	80 mm

Code	No.	tlg.			EAN
00078301083	78-3010-M	18	4920	1	100709

wie/as 78-0010-M, jedoch/but

Stck./pcs.	Artikel/article	No.	Maße/dimensions
13		50-6 CPP	MM 10 11 12 13 14 15 17 19 22 24 27 30 32

Code	No.	tlg./pcs.			EAN
00078000083	78-0-M	18	4160	1	006087

wie/as 78-0010-M, jedoch/but

Stck./pcs.	Artikel/article	No.	Maße/dimensions
1		50-00-7 CP	270 mm – 48 Zähne /teeth/dents/dientes

Code	No.	tlg./pcs.			EAN
00078300083	78-30-M	18	4200	1	006117

wie/as 78-0010-M, jedoch/but

Stck./pcs.	Artikel/article	No.	Maße/dimensions
13		50-6 CPP	MM 10 11 12 13 14 15 17 19 22 24 27 30 32
1		50-00-7 CP	270 mm – 48 Zähne /teeth/dents/dientes

1/2"

79-0010 - 79-3310

Steckschlüssel-Garnituren

Chrom-Vanadium, CPP = verchromt, ganz poliert
Metallkasten 450 x 187 x 52 mm

Socket sets

Chrome-Vanadium, CPP = chromium plated, fully polished
Metal case 450 x 187 x 52 mm

Compositions de douilles

Chrom-Vanadium, CPP = chromées, entièrement polies
Coffret métallique 450 x 187 x 52 mm

Juegos de llaves de vaso









Cromo Vanadio, CPP = cromado, enteramente pulido espejo
Caja metálica 450 x 187 x 52 mm

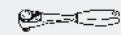

1/2"

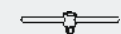

Code	No.	tlg./pcs.	g	box	EAN
00079001083	79-0010-M	32	6190	1	100730

enthaltend/containing

Stck./pcs.	Artikel/article	No.	Maße/dimensions
18	 	50-12 CPP	MM 8 10 11 12 13 14 15 16 17 18 19 21 22 24 27 30 32 34
1		50-00-10	270 mm – 48 Zähne /teeth/dents/dientes
8	 	50-31 CPP	MM 4 5 6 7 8 10 12 14
1		50-03 CPP	300 mm
1		50-04 CPP	125 mm
1		50-04-1 CPP	75 mm
1		50-05 CPP	250 mm
1		50-06 CPP	80 mm



Code	No.	tlg./pcs.	g	box	EAN
00079301083	79-3010-M	32	6320	1	095364

wie/as 79-0010-M, jedoch/but

Stck./pcs.	Artikel/article	No.	Maße/dimensions
18	 	50-6 CPP	MM 8 10 11 12 13 14 15 16 17 18 19 21 22 24 27 30 32 34





Code	No.	tlg./pcs.	g	box	EAN
00079031083	79-0310-M	32	6110	1	097351

wie/as 79-0010-M, jedoch/but

Stck./pcs.	Artikel/article	No.	Maße/dimensions
8	 	50-36 CPP	T 25 T 27 T 30 T 40 T 45 T 50 T 55 T 60

Code	No.	tlg./pcs.	g	box	EAN
00079331083	79-3310-M	32	6240	1	095333

wie/as 79-0010-M, jedoch/but

Stck./pcs.	Artikel/article	No.	Maße/dimensions
18	 	50-6 CPP	MM 8 10 11 12 13 14 15 16 17 18 19 21 22 24 27 30 32 34
8	 	50-36 CPP	T 25 T 27 T 30 T 40 T 45 T 50 T 55 T 60



ANTRIEBS- UND VERBINDUNGSTEILE DRIVE AND CONNECTING PARTS

Chrom-Vanadium
C = verchromt
mit Stiftsicherung

Chrome-Vanadium
C = chromium plated
with locking pin

100-00-6 DIN 3122 D · ISO 3315

Umschaltknarre
Reversible ratchet
Cliquet réversible
Carraca reversible



50 Zähne/teeth/dents/dientes

Code	No.	Ausf. finish	←L→ mm			EAN
00100000680	100-00-6	C	490	1535	2	006582

100-01-1 DIN 3122 C · ISO 3315

Durchsteckknarre
Ratchet, push-thru type
Cliquet
Carraca de cuadradillo pasante



36 Zähne/teeth/dents/dientes

Code	No.	Ausf. finish	←L→ mm			EAN
00100011080	100-01-1	C	490	1460	2	006735

100-03-1 DIN 3122 A · ISO 3315

Griff mit Gleitstück
Sliding T-handle
Poignée coulissante
Mango corredizo



Code	No.	Ausf. finish	←L→ mm			EAN
00100030180	100-03-1	C	485	1445	2	006759

100-04 100-05 DIN 3123 B · ISO 3316

Verlängerung
Extension bar
Rallonge
Alargadera



Code	No.	Ausf. finish	←L→ mm			EAN
00100040080	100-04	C	200	550	2	006971
00100050080	100-05	C	400	1050	2	006988

100-06 DIN 3123 C · ISO 3316

Kardangelnk
Universal joint
Cardan universal
Articulación universal



Code	No.	Ausf. finish	←L→ mm			EAN
00100060080	100-06	C	110	535	2	006995

100-14 **100-15** DIN 3123 A · ISO 3316

Verbindungsstück
Converter
Réducteur
Reductor



Code	No.	Ausf. finish	←L→ mm			EAN
00100140080	100-14	C	60	160	10	007015
00100150080	100-15	C	60	325	10	007022

100-16 DIN 3122 CV · ISO 3315

Verbindungsvierkant
Square coupler
Carré conducteur
Adaptador



Code	No.	Ausf. finish	←L→ mm			EAN
00100160080	100-16	C	45	130	10	007039



100-6

DIN 3124 / ISO 2725



Steckschlüssel-Einsätze

Chrom-Vanadium, C = verchromt. mit Stiftsicherung

Sockets

Chrome-Vanadium, C = chromium plated, with locking pin

Douilles

Chrome-Vanadium, C = chromées, avec poussoir de verrouillage de sécurité

Llaves de vaso

Cromo Vanadio, C = cromado. con pasador de seguridad

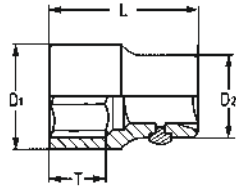

Code	ØMM	←L→ mm	T mm	D ₁ mm	D ₂ mm	g		EAN
00100602280	22	52	18,0	32,2	36,0	220	5	007053
00100602480	24	52	18,0	34,2	36,0	220	5	007060
00100602780	27	54	18,0	38,0	36,0	225	5	007077
00100603080	30	56	20,0	42,0	38,0	280	5	007084
00100603280	32	56	22,0	44,0	38,0	320	5	007091
00100603680	36	65	24,0	50,0	42,0	440	5	007107
00100603880	38	65	25,0	52,0	45,0	480	5	007114
00100604180	41	65	27,0	56,0	45,0	570	5	007121
00100604680	46	65	30,0	62,0	49,2	690	5	007138
00100605080	50	65	32,0	68,0	48,0	820	5	007145
00100605580	55	70	32,0	74,5	48,0	960	5	007152

100-12

DIN 3124 / ISO 2725



Steckschlüssel-Einsätze

Chrom-Vanadium, C = verchromt, mit Stiftsicherung

Sockets

Chrome-Vanadium, C = chromium plated with locking pin

Douilles

Chrome-Vanadium, C = chromées avec poussoir de verrouillage de sécurité

Llaves de vaso

Cromo Vanadio, C = cromado con pasador de seguridad

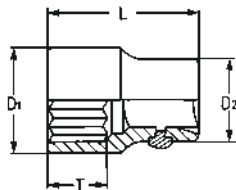

Code	ØMM	←L→ mm	T mm	D ₁ mm	D ₂ mm	g		EAN
00100002280	22	52	18,0	32,3	36,0	210	5	006599
00100002480	24	52	18,0	34,2	36,0	210	5	006605
00100002780	27	54	18,0	38,0	36,0	220	5	006612
00100002980	29	56	20,0	40,0	38,0	250	5	006629
00100003080	30	56	20,0	42,0	38,0	275	5	006636
00100003280	32	56	22,0	44,0	38,0	300	5	006643
00100003380	33	56	22,0	46,0	38,0	315	5	006650
00100003680	36	65	24,0	50,0	42,0	415	5	006667
00100003880	38	65	25,0	52,0	45,0	470	5	006674
00100004180	41	65	27,0	56,0	45,0	550	5	006681
00100004680	46	65	30,0	62,0	49,5	610	5	006698
00100005080	50	65	32,0	68,0	48,0	790	5	006704
00100005580	55	70	32,0	74,5	48,0	860	5	006711
00100006080	60	70	32,0	80,5	48,0	1020	5	006728

Code	ØAF	←L→ mm	T mm	D ₁ mm	D ₂ mm	g		EAN
00100033480	7/8	52	18,0	32,2	36,0	200	5	006803
00100033580	15/16	52	18,0	34,2	36,0	220	5	006810
00100033780	1	54	18,0	37,0	36,0	210	5	006827
00100033880	1.1/16	54	18,0	38,5	36,0	220	5	006834
00100033980	1.1/8	54	18,0	40,0	38,0	250	5	006841
00100034080	1.3/16	56	20,0	42,0	38,0	275	5	006858
00100034180	1.1/4	56	22,0	44,0	38,0	300	5	006865
00100034280	1.5/16	56	22,0	46,0	38,0	325	5	006872
00100034380	1.3/8	65	24,0	48,0	42,0	400	5	006889
00100034480	1.7/16	65	24,0	50,0	42,0	425	5	006896
00100034580	1.1/2	65	25,0	52,0	45,0	470	5	006902
00100034780	1.5/8	65	27,0	56,0	45,0	540	5	006919
00100034880	1.11/16	65	30,0	58,0	45,0	570	5	006926
00100034980	1.3/4	65	30,0	60,0	48,0	620	5	006933
00100035080	1.13/16	65	30,0	62,0	49,5	655	5	006940
00100035180	1.7/8	65	30,0	64,0	48,0	700	5	006957
00100035280	2	65	32,0	68,0	48,0	745	5	006964



100-31

Schraubendreher-Einsätze

Für Innensechskant-Schrauben
Körper: Chrom-Vanadium, CPP = verchromt, ganz poliert
mit Stiftsicherung. Bits: Sonderstahl, PH = phosphatiert

Screwdriver sockets

For hexagon socket screws
Socket bodies: Chrome-Vanadium, CPP = chromium plated, fully
polished, with locking pin. Bits: Special steel, PH = phosphated

Douilles tournevis

Pour vis à six pans creux
Douilles: Chrome-Vanadium, CPP = chromées, entièrement polies, avec pois-
soir de verrouillage de sécurité- Embouts: Acier Spécial, PH = phosphaté

Llaves de vaso con destornillador

Para tornillos hexagonales
Cuerpo: Cromo Vanadio, CPP = cromado, enteramente pulido espejo,
con pasador de seguridad- Puntas: Acero aleado, PH = fosfatado

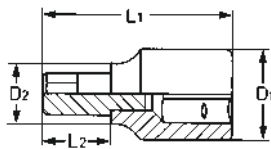

101-0 - 101-80

Steckschlüssel-Garnituren

Chrom-Vanadium, C = verchromt
Metallkasten 515 x 220 x 84 mm

Socket sets

Chrome-Vanadium, C = chromium plated
Metal case 515 x 220 x 84 mm

Compositions de douilles

Chrome-Vanadium, C = chromées
Coffret métallique 515 x 220 x 84 mm

Juegos de llaves de vaso

Cromo Vanadio, C = cromado
Caja metálica 515 x 220 x 84 mm



Code	MM	D ₁ mm	D ₂ mm	L ₁ mm	L ₂ mm	g	g	EAN
00100311480	14	33,5	27	80	30	260	5	392722
00100311780	17	33,5	27	80	30	260	5	392739
00100311980	19	35,5	35,5	80	30	380	5	392746
00100312280	22	35,5	35,5	80	30	400	5	393415

Code	No.	tlg./pcs.	g	g	EAN
00101000080	101-0-M	14	11700	1	007237

enthaltend/containing

Stck./pcs.	Artikel/article	No.	Maße/dimensions
10		100-12 C	MM 22 24 27 30 32 36 38 41 46 50
1		100-00-6 C	490 mm
1		100-03-1 C	485 mm
1		100-04 C	200 mm
1		100-05 C	400 mm

Code	No.	tlg./pcs.	g	g	EAN
00101500080	101-50-M	14	11625	1	007299

wie/as 101-0-M, jedoch/but

Stck./pcs.	Artikel/article	No.	Maße/dimensions
1		100-01-1 C	490 mm

Code	No.	tlg./pcs.	g	g	EAN
00101300080	101-30-M	14	11925	1	007282

wie/as 101-0-M, jedoch/but

Stck./pcs.	Artikel/article	No.	Maße/dimensions
10		100-6 C	MM 22 24 27 30 32 36 38 41 46 50

Code	No.	tlg./pcs.	g	g	EAN
00101800080	101-80-M	14	11850	1	007329

wie/as 101-0-M, jedoch/but

Stck./pcs.	Artikel/article	No.	Maße/dimensions
10		100-6 C	MM 22 24 27 30 32 36 38 41 46 50
1		100-01-1 C	490 mm

Code	No.	tlg./pcs.	g	g	EAN
00101100080	101-10-AF	14	11405	1	007275

wie/as 101-0-M, jedoch/but

Stck./pcs.	Artikel/article	No.	Maße/dimensions
10		100-12	AF 7/8 15/16 1 1.1/16 1.1/8 1.1/4 1.1/2 1.5/8 1.3/4 2

Code	No.	tlg./pcs.	g	g	EAN
00101600080	101-60-AF	14	11330	1	007312

wie/as 101-0-M, jedoch/but

Stck./pcs.	Artikel/article	No.	Maße/dimensions
10		100-12	AF 7/8 15/16 1 1.1/16 1.1/8 1.1/4 1.1/2 1.5/8 1.3/4 2
1		100-01-1 C	490 mm



ANTRIEBS- UND VERBINDUNGSTEILE

DRIVE AND CONNECTING PARTS

Chrom-Vanadium
C = verchromt,
mit Stiftsicherung

Chrome-Vanadium
C = chromium plated,
with locking pin

105-00-6

DIN 3122 D · ISO 3315

Umschalknarre
Reversible ratchet
Cliquet réversible
Carraca reversible



72 Zähne/teeth/dents/dientes

Code	No.	Ausf. finish	←L→ mm	g		EAN
00105000680	105-00-6	C	640	3835	1	007350

105-03

DIN 3122 A · ISO 3315

Griff mit Gleitstück
Sliding T-handle
Poignée articulée
Mango corredizo



Code	No.	Ausf. finish	←L→ mm	g		EAN
00105030080	105-03	C	640	3010	1	007466

105-04 105-05

DIN 3123 B · ISO 3316

Verlängerung
Extension bar
Rallonge
Alargadera



Code	No.	Ausf. finish	←L→ mm	g		EAN
00105040080	105-04	C	205	1065	2	007602
00105050080	105-05	C	405	1825	2	007619

105-14

DIN 3123 A · ISO 3316

Verbindungsstück
Converter
Réducteur
Reducer



Code	No.	Ausf. finish	←L→ mm	g		EAN
00105140080	105-14	C	80	475	2	007626

105-12

DIN 3124 / ISO 2725

Steckschlüssel-Einsätze

Chrom-Vanadium, C = verchromt, mit Stiftsicherung

Sockets

Chrome-Vanadium, C = chromium plated, with locking pin

Douilles

Chrome-Vanadium, C = chromées, avec poussoir de verrouillage de sécurité

Llaves de vaso

Cromo Vanadio, C = cromado, con pasador de seguridad



Code	MM	←L→ mm	T mm	D ₁ mm	D ₂ mm	g	g	EAN
00105003680	36	64	32,5	54,0	51,0	580	1	007367
00105004180	41	70	32,0	57,0	45,0	695	1	007374
00105004680	46	75	34,0	65,0	50,0	890	1	007381
00105005080	50	77	38,0	71,0	54,0	1050	1	007398
00105005580	55	82	41,0	77,5	57,0	1325	1	007404
00105006080	60	86	43,5	83,5	57,0	1505	1	007411
00105006580	65	87	44,0	88,0	55,0	1715	1	007428
00105007080	70	95	49,0	96,0	60,0	2030	1	007435
00105007580	75	100	52,5	102,5	60,0	2280	1	007442
00105008080	80	103	54,0	105,0	60,0	2670	1	007459

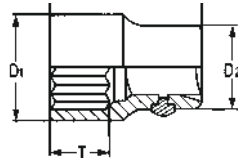

Code	AF	←L→ mm	T mm	D ₁ mm	D ₂ mm	g	g	EAN
00105034580	1.1/2	68	35,5	56,0	51,0	640	1	007480
00105035280	2	77	38,0	71,0	54,0	1020	1	007527
00105035680	2.1/4	84	42,5	80,0	57,0	1360	1	007541
00105035880	2.3/8	86	43,5	83,5	57,0	1500	1	007558
00105036280	2.5/8	92	47,0	92,0	57,0	1895	1	007565

106-0

Steckschlüssel-Garnitur

Chrom-Vanadium, C = verchromt Metallkasten 775 x 260 x 125 mm

Socket set

Chrome-Vanadium, C = chromium plated Metal case 775 x 260 x 125 mm

Compositions de douilles

Chrome-Vanadium, C = chromées Coffret métallique 775 x 260 x 125 mm

Juegos de llaves de vaso

Cromo Vanadio, C = cromado Caja metálica 775 x 260 x 125 mm



Code	No.	tlg./pcs.	g	g	EAN
00106000080	106-0-M	14	31340	1	007633

enthaltend/containing

Stck./pcs.	Artikel/article	No.	Maße/dimensions
10		105-12 C	MM 36 41 46 50 55 60 65 70 75 80
1		105-00-6 C	640 mm
1		105-03 C	640 mm
1		105-04 C	205 mm
1		105-05 C	405 mm



IMPACT STECKSCHLÜSSEL-EINSÄTZE SOCKET PROGRAM

für Maschinen-Schrauber
for impact and power drive
pour Boulonneuses (air comprimé)
para uso en atornilladores



3305

Schlagdreher

N = vernickelt, mit Kugel-Arretierung, einstellbar für Rechts- und Linksgang

Impact drivers

N = nickel plated, with spring-loaded retaining ball, adjustable for right- and left hand rotation

Tournevis à frapper

N = nickelées, avec arrêt par bille de verrouillage, réglable pour pas à droite et gauche, 120 Nm

Destornilladores de golpe

N = niquelado, reversibles para giro a derecha e izquierda, 120 Nm con retención por bola

1/2"



Code	←L→ mm	∅ mm	g		EAN
03305000050	140	33,0	635	1	034806

3310

Schlagschraubendreher-Satz

ST = standardmäßig
Metallkasten 225 x 115 x 40 mm

Impact driver set

ST = standard
Metal case 225 x 115 x 40 mm

Compositions de tournevis à frapper

ST = standard
Coffrets métalliques 225 x 115 x 40 mm

Juegos de destornilladores de golpe

ST = estándar
Cajas metálicas 225 x 115 x 40 mm



Code	No.	tlg./pcs.	g		EAN
03310000000	3310	13	1325	1	034813

enthaltend/containing

Stck. pcs.	Artikel/article	No.	Maße/dimensions
1	1/2"	3305	Schlagdreher/impact driver
1	3/16"	6302-31	Verbindungsstück/adapter
je 1 each		3501-2	Bit-Schraubendrehereinsatz/screwdriver bit für Schlitzschrauben/for plain slot screws
		3501-4	6 x 1,0 mm
		3501-5	8 x 1,2 mm
		3501-7	9 x 1,6 mm
		3501-7	12 x 2,0 mm
je 1 each		3511-3	Bit-Schraubendrehereinsatz/screwdriver bit für Innensechskantschrauben/for hexagon socket screws
		3511-4	MM 5
		3511-5	MM 6
		3511-6	MM 8
		3511-6	MM 10
je 1 each		3521-2	Bit-Schraubendrehereinsatz/screwdriver bit für Kreuzschlitzschrauben/for cross slot screws
		3521-3	PH No. 2
		3521-4	PH No. 3
		3521-4	PH No. 4
4			T 30 T 40 T 45 T 50

6300

DIN 3129 / ISO 2725

IMPACT-Steckschlüssel-Einsätze

Chrom Molybdän, PH = phosphatiert

IMPACT-Sockets

Chrome molybdenum, PH = phosphated

Douilles IMPACT

Chrome molybdène, PH = phosphatées

Llaves de vaso de IMPACTO

Cromo molibdeno, PH = fosfatado

1/2" SP

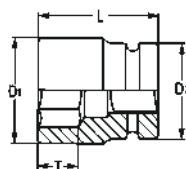

Code	∅MM	←L→ mm	T mm	D ₁ mm	D ₂ mm	g		EAN
06300000836	8	38	9	16,0	25,0	87	10	036602
06300001036	10	38	12	17,4	25,0	88	10	036619
06300001136	11	38	12	18,7	25,0	88	10	036626
06300001236	12	38	12	20,0	25,0	90	10	036633
06300001336	13	38	12	21,0	25,0	89	10	036640
06300001436	14	38	12	22,5	25,0	90	10	036657
06300001536	15	38	12	23,5	30,0	130	10	036664
06300001636	16	38	13	24,0	30,0	130	10	036671
06300001736	17	38	13	26,5	30,0	130	10	036688
06300001836	18	38	13	26,5	30,0	130	10	036695
06300001936	19	38	13	28,5	30,0	130	10	036701
06300002036	20	38	13	30,0	30,0	130	10	036718
06300002136	21	38	13	30,2	30,0	130	10	036725
06300002236	22	38	13	32,8	30,0	145	10	036732
06300002336	23	38	13	33,5	30,0	130	10	036749
06300002436	24	45	20	35,5	30,0	180	10	036756

6300

DIN 3129 / ISO 2725



IMPACT-Steckschlüssel-Einsätze

Chrom Molybdän, PH = phosphatiert

IMPACT-Sockets

Chrome molybdenum, PH = phosphated

Douilles IMPACT

Chrome molybdène, PH = phosphatées

Llaves de vaso de IMPACTO

Cromo molibdeno, PH = fosfatado

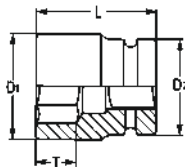

Code	MM	←L→ mm	T mm	D ₁ mm	D ₂ mm	g		EAN
06300002736	27	50	22	39,0	30,0	200	10	036787
06300003036	30	50	22	42,5	30,0	225	10	036794
06300003236	32	50	17	44,0	30,0	240	10	395969
06300003336	33	50	17	46,0	38,0	255	10	395976
06300003436	34	50	17	48,0	38,0	288	10	395983

Code	AF	←L→ mm	T mm	D ₁ mm	D ₂ mm	g		EAN
06300032136	7/16	40	6,0	18	24,0	71	10	395822
06300032336	1/2	40	6,0	20	24,0	71	10	395839
06300032536	9/16	40	7,0	22	24,0	71	10	395846
06300032736	5/8	40	8,0	25	25,0	77	10	395853
06300032936	11/16	40	9,0	26	26,0	94	10	395860
06300033136	3/4	40	9,5	28	28,0	113	10	395877
06300033336	13/16	40	11,0	30	30,0	121	10	395884
06300033436	7/8	40	13,0	32	30,0	133	10	395891
06300033536	15/16	40	13,0	34	30,0	152	10	395907
06300033736	1	40	13,0	36	30,0	142	10	395914
06300033836	1.1/16	45	13,0	38	30,0	181	10	395921
06300033936	1.1/8	50	17,0	40	30,0	209	10	395938
06300034236	1.1/4	50	17,0	44	30,0	240	10	395945
06300034136	1.5/16	50	17,0	46	38,0	256	10	395952

6300-19

DIN 3129 / ISO 2725

IMPACT-Steckschlüssel-Einsätze, extra lang

Chrom Molybdän, PH = phosphatiert

IMPACT-Sockets, extra deep

Chrome molybdenum, PH = phosphated

Douilles IMPACT, extra longues

Chrome molybdène, PH = phosphatées

Llaves de vaso de IMPACTO, serie extra-larga

Cromo molibdeno, PH = fosfatado

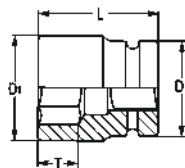

Code	MM	←L→ mm	T mm	D ₁ mm	D ₂ mm	g		EAN
06300190836	8	78	4,0	15,0	24,0	117	10	395990
06300191036	10	78	14,0	17,5	25,0	155	10	036800
06300191336	13	78	14,0	21,3	25,0	165	10	036817
06300191436	14	78	17,0	22,5	25,0	175	10	036824
06300191636	16	78	17,0	25,0	30,0	240	10	036831
06300191736	17	78	17,0	26,0	30,0	250	10	036848
06300191836	18	78	17,0	27,8	30,0	250	10	036855
06300191936	19	78	19,0	28,7	30,0	260	10	036862
06300192136	21	78	24,0	30,0	30,0	245	10	036879
06300192236	22	78	24,0	32,0	30,0	270	10	036886
06300192336	23	78	13,0	32,0	30,0	277	10	396003
06300192436	24	78	24,0	35,0	30,0	280	10	036893
06300192736	27	78	24,0	38,7	30,0	310	10	036909
06300193036	30	78	16,5	42,0	30,0	456	10	396010
06300193236	32	78	17,0	44,0	30,0	376	10	396027

IMPACT

6300-19

IMPACT-Steckschlüssel-Garnitur, extra lang

Chrom Molybdän, PH = phosphatiert
In hochwertiger 2-K Schaumstoffeinlage
Metallkasten 318 x 119 x 49 mm

IMPACT-Socket set, extra deep

Chrome molybdenum, PH = phosphated
High quality 2-K-foam insert
Metal case 318 x 119 x 49 mm

IMPACT Compositions de douilles, extra longues

Chrome molybdène, PH = phosphatées
Insert en mousse de haute qualité en 2 composants
Coffret métallique 318 x 119 x 49 mm

Juegos de llaves de vaso de IMPACTO, extra-larga

Cromo molibdeno, PH = fosfatado
En bandeja de polispam de gran calidad
Cajas metálicas 318 x 119 x 49 mm



Code	No.	tlg./pcs.			EAN
06300901136	6300-19-M	10	3972	1	366518

enthaltend/containing					
Stck./pcs.	Artikel/article	No.	Maße/dimensions		
10		6300-19	MM 13 14 16 17 18 19 21 22		
			24 27		



6300-18

DIN 3129 / ISO 2725

IMPACT-Einsätze, mit Schutzhülse

Chrom Molybdän, PH = phosphatiert

IMPACT-Sockets, with plastic sleeve

Chrome molybdenum, PH = phosphated

Douilles IMPACT avec manchon de protection

Chrome molybdène, PH = phosphatées

Llaves de vaso de IMPACTO con casquillo de protección

Cromo molibdeno, PH = fosfatado



Code	MM	←L→ mm	T mm	D ₁ mm	D ₂ mm			EAN
06300181736	17	85	20	24,3	30,0	204	10	396034
06300181936	19	85	20	26,3	30,0	212	10	396041
06300182136	21	85	20	28,3	30,0	235	10	396058
06300182236	22	85	20	30,3	32,0	267	10	396065



6300-31

DIN 3129 / ISO 2725

IMPACT-Schraubendreher-Einsätze für Innensechskant-Schrauben

Chrom Molybdän
PH = phosphatiert

IMPACT-Screwdriver-sockets for hexagon socket screws

Chrome molybdenum
PH = phosphated

Douille tournevis IMPACT pour vis six pans

Chrome molybdène
PH = phosphatées

Destornillador de IMPACTO para tornillos de hexágono interior

Cromo molibdeno
PH = fosfatado



Code	MM	←L→ mm	T mm	D ₂ mm			EAN
06300310236	5	60	10	25,0	76	10	396072
06300310336	6	60	10	25,0	78	10	396089
06300310436	8	60	10	25,0	88	10	396096
06300310536	10	60	10	25,0	95	10	396102
06300310636	12	60	10	25,0	105	10	396119
06300310736	14	60	10	25,0	121	10	396126
06300310836	17	60	10	25,0	145	10	396133
06300310936	19	60	10	25,0	163	10	396140



IMPACT

6300-20

DIN 3129 / ISO 2725



IMPACT-Steckschlüssel-Einsätze für Aussen-TORX® Schrauben

Chrom Molybdän, PH = phosphatiert

IMPACT-Sockets for TORX®-Head screws

Chrome molybdenum, PH = phosphated

Douille IMPACT pour vis mâles TORX®

Chrome molybdène, PH = phosphatées

Destornillador de IMPACTO para tornillos TORX® exteriores

Cromo molibdeno, PH = fosfatado



Code	mm	←L→ mm	T mm	D ₁ mm	D ₂ mm	g		EAN
06300201036	E 10	38	10	15,0	25,0	88	10	396157
06300201236	E 12	38	10	16,0	25,0	87	10	396171
06300201436	E 14	38	10	19,0	25,0	89	10	396195
06300201636	E 16	38	10	20,0	25,0	87	10	396201
06300201836	E 18	38	10	22,0	25,0	88	10	396218
06300202036	E 20	38	10	25,0	25,0	136	10	396225
06300202436	E 24	45	10	28,5	30,0	159	10	396232

6300-36

DIN 3129 / ISO 2725



IMPACT-Schraubendreher Einsätze für Innen-TORX® Schrauben

Chrom Molybdän, PH = phosphatiert

IMPACT-Screwdriver sockets for TORX® socket screws

Chrome molybdenum, PH = phosphated

Douille tournevis IMPACT pour vis TORX®

Chrome molybdène, PH = phosphatées

Destornillador de IMPACTO para tornillos TORX® interiores

Cromo molibdeno, PH = fosfatado



Code	mm	←L→ mm	T mm	D ₂ mm	g		EAN
06300363036	T-30	60	3,18	25,0	76	10	396249
06300364036	T-40	60	3,30	25,0	78	10	396256
06300364536	T-45	60	3,81	25,0	81	10	396263
06300365036	T-50	60	4,57	25,0	84	10	396270
06300366036	T-60	60	7,62	25,0	101	10	396294
06300367036	T-70	60	8,89	25,0	113	10	396287

6300-50

DIN 3129 / ISO 2725



IMPACT-Schraubendreher- und Steckschlüsseinsatz-Sortiment, 13-tlg.

Für Aussen-TORX® Schrauben und Innen-TORX® Schrauben.

Chrom Molybdän, PH = phosphatiert

Metallkasten 220 x 110 x 40 mm

IMPACT-Combined set of sockets and screwdriver sockets, 13 pcs.

For TORX®-Head screws and TORX® socket screws.

Chrome molybdenum, PH = phosphated

Metal case 220 x 110 x 40 mm

Tournevis IMPACT et jeu de douilles, 13 pcs.

Pour vis mâles TORX® et vis TORX®.

Chrome molybdène, PH = phosphatées

Coffret métallique 220 x 110 x 40 mm

Juego combinado de destornilladores y vasos de IMPACTO, de 13 piezas

Para tornillos TORX® exteriores y tornillos TORX® interiores.

Cromo molibdeno, PH = fosfatado

Cajas metálicas 220 x 110 x 40 mm

Code	No.	tlg./pcs.	g		EAN
06300500036	6300-50	13	1750	1	405859

enthaltend/containing

Stk./pcs.	Artikel/article	No.	Maße/dimensions
7		6300-20	E 10 12 14 16 18 20 24
6		6300-36	T 30 40 45 50 60 70



IMPACT

6300-55

DIN 3129 / ISO 2725



IMPACT-Schraubendrehereinsatz-Sortiment, 8-tlg.

Für Innensechskant-Schrauben.
Chrom Molybdän, PH = phosphatiert
Metallkasten 170 x 80 x 30 mm

IMPACT-Set with screw-driver sockets, 8 pcs.

For hexagon socket screws.
Chrome molybdenum, PH = phosphated
Metal case 170 x 80 x 30 mm

Jeu de douilles tournevis IMPACT, 8 pcs.

Pour vis six pans.
Chrom molybdène, PH = phosphatées
Coffret métallique 170 x 80 x 30 mm

Juego de destornilladores de IMPACTO, de 8 piezas

Para tornillos de hexágono interior.
Cromo molibdeno, PH = fosfatado
Cajas metálicas 170 x 80 x 30 mm



Code	No.	tlg./pcs.			EAN
06300550036	6300-55	8	800	1	405804

enthaltend/containing			
Stck./pcs.	Artikel/article	No.	Maße/dimensions
8		6300-31	MM 5 6 8 10 12 14 17 19

6300-58

DIN 3129 / ISO 2725



IMPACT-Schraubendreher-einsatz-Sortiment, 6-tlg.

Für Innen-TORX® Schrauben.
Chrom Molybdän, PH = phosphatiert
Metallkasten 170 x 80 x 30 mm

IMPACT-Set with screw-driver sockets, 6 pcs.

For TORX® socket screws.
Chrome molybdenum, PH = phosphated
Metal case 170 x 80 x 30 mm

Jeu de douilles tournevis IMPACT, 6 pcs.

Pour vis TORX®.
Chrom molybdène, PH = phosphatées
Coffret métallique 170 x 80 x 30 mm

Juego de destornilladores de IMPACTO, de 6 piezas

Para tornillos TORX® interiores.
Cromo molibdeno, PH = fosfatado
Cajas metálicas 170 x 80 x 30 mm



Code	No.	tlg./pcs.			EAN
06300580036	6300-58	6	800	1	405835

enthaltend/containing			
Stck./pcs.	Artikel/article	No.	Maße/dimensions
6		6300-36	T 30 40 45 50 60 70

IMPACT

6500

DIN 3129 / ISO 2725



IMPACT-Steckschlüssel-Einsätze

Chrom Molybdän, PH = phosphatiert

IMPACT-Sockets

Chrome molybdenum, PH = phosphated

Douilles IMPACT

Chrome molybdène, PH = phosphatées

Llaves de vaso de IMPACTO

Cromo molibdeno, PH = fosfatado

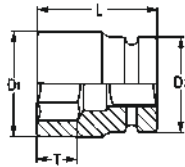

Code	MM	←L→ mm	T mm	D ₁ mm	D ₂ mm	g		EAN
06500001736	17	50	12	31,0	44,0	365	10	037050
06500001836	18	51	14	31,0	44,0	330	10	396300
06500001936	19	50	14	33,0	44,0	389	10	037067
06500002236	22	50	16	37,0	44,0	375	10	037074
06500002436	24	50	16	39,2	44,0	390	10	037081
06500002736	27	54	16	43,0	44,0	415	10	037098
06500003036	30	54	23	47,0	44,0	430	10	037104
06500003236	32	56	23	49,2	44,0	450	10	037111
06500003336	33	56	23	51,0	44,0	485	5	037128
06500003436	34	57	21	51,0	44,0	500	5	396317
06500003636	36	56	23	54,0	44,0	505	5	037135
06500003836	38	58	24	57,0	44,0	568	5	037142
06500004136	41	58	24	60,0	44,0	640	5	037159
06500004636	46	63	27	67,0	44,0	740	5	037166

Code	AF	←L→ mm	T mm	D ₁ mm	D ₂ mm	g		EAN
06500033436	7/8	51	14	36,00	42,0	320	10	396324
06500033536	15/16	51	14	38,50	42,0	340	10	396331
06500033736	1	53	16	40,00	42,0	340	10	396348
06500033836	1.1/16	53	20	42,50	44,0	380	10	396355
06500033936	1.1/8	53	20	44,00	44,0	390	10	396362
06500034136	1.1/4	57	21	48,50	44,0	450	5	396379
06500034236	1.5/16	57	21	50,00	44,0	490	5	396386
06500034336	1.3/8	57	21	52,50	44,0	500	5	396393
06500034436	1.7/16	57	21	53,50	44,0	500	5	396409
06500034536	1.1/2	57	22	56,02	44,0	520	5	396416
06500034736	1.5/8	58	22	60,00	44,0	590	5	396423
06500034836	1.11/16	62	25	62,50	44,0	650	5	396430
06500034936	1.3/4	62	25	64,00	44,0	670	5	396447
06500035236	1.7/8	68	30	68,00	44,0	820	1	396454
06500035136	2	68	30	71,00	44,0	830	1	396461

6500-19

DIN 3129 / ISO 2725



IMPACT-Steckschlüssel-Einsätze, extra lang

Chrom Molybdän, PH = phosphatiert

IMPACT-Sockets, extra deep

Chrome molybdenum, PH = phosphated

Douilles IMPACT, extra longues

Chrome molybdène, PH = phosphatées

Llaves de vaso de IMPACTO, serie extra-larga

Cromo molibdeno, PH = fosfatado

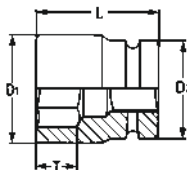

Code	MM	←L→ mm	T mm	D ₁ mm	D ₂ mm	g		EAN
06500191736	17	90	26	30,0	44,0	490	5	396591
06500191936	19	95	23	33,0	44,0	590	5	037173
06500192136	21	90	26	35,0	44,0	530	5	396607
06500192236	22	95	23	37,0	44,0	655	5	037180
06500192436	24	95	51	39,2	44,0	710	5	037197
06500192736	27	95	62	42,5	44,0	780	5	037203
06500193036	30	95	62	47,0	44,0	710	5	037210
06500193236	32	95	62	49,2	44,0	890	5	037227
06500193336	33	95	62	51,0	44,0	810	5	037234
06500193436	34	95	62	52,0	44,0	835	5	037241
06500193636	36	95	62	54,0	44,0	995	5	037258
06500193836	38	90	34	56,0	44,0	880	5	396614
06500194136	41	95	60	60,0	44,0	1100	5	037265
06500194636	46	90	34	66,0	44,0	1500	2	037272

6500-31

DIN 3129 / ISO 2725



IMPACT-Schraubendreher-Einsätze

für Innensechskant-Schrauben

Chrom Molybdän, PH = phosphatiert

IMPACT-Screwdriver-sockets for hexagon socket screws

Chrome molybdenum, PH = phosphated

Douille tournevis IMPACT pour vis six pans

Chrome molybdène, PH = phosphatées

Destornillador de IMPACTO

para tornillos de hexágono interior

Cromo molibdeno, PH = fosfatado



Code	MM	←L→ mm	T mm	D ₂ mm	g		EAN
06500310736	14	90	20	44,0	550	10	396621
06500310836	17	90	20	44,0	570	10	396638
06500310936	19	90	20	44,0	580	10	396645
06500312036	22	90	20	44,0	600	10	396652
06500312136	24	90	20	44,0	620	10	396669
06500312236	27	90	20	44,0	650	10	396676

IMPACT

6600

DIN 3129 / ISO 2725

IMPACT-Steckschlüssel-Einsätze

Chrom Molybdän, PH = phosphatiert

IMPACT-Sockets

Chrome molybdenum, PH = phosphated

Douilles IMPACT

Chrome molybdène, PH = phosphatées

Llaves de vaso de IMPACTO

Cromo molibdeno, PH = fosfatado

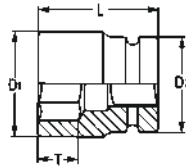

Code	ØMM	←L→ mm	T mm	D ₁ mm	D ₂ mm	g		EAN
06600001936	19	58	17	35,0	54,0	565	5	037517
06600002436	24	58	17	42,0	54,0	640	5	037531
06600002736	27	58	17	46,0	54,0	640	5	037548
06600003036	30	60	21	50,0	54,0	688	5	037562
06600003236	32	60	21	52,0	54,0	678	5	037579
06600003336	33	60	21	53,0	54,0	683	5	037586
06600003436	34	64	22	54,0	54,0	710	5	396683
06600003636	36	65	30	56,0	54,0	678	5	037593
06600003836	38	65	30	59,0	54,0	752	5	037609
06600004136	41	67	31	63,0	54,0	886	5	037623
06600004236	42	68	24	64,0	54,0	900	5	396690
06600004636	46	74	36	69,0	54,0	1018	5	037630
06600005036	50	80	42	74,0	54,0	1220	1	037647
06600005536	55	84	44	80,0	54,0	1425	1	037654
06600006036	60	87	44	86,0	54,0	1840	1	037661
06600006536	65	90	46	92,0	54,0	2100	1	037678
06600007036	70	96	40	99,0	54,0	2300	1	396706
06600007536	75	102	45	105,0	60,3	2830	1	396713
06600008036	80	102	45	111,5	60,3	2890	1	396720

Code	ØAF	←L→ mm	T mm	D ₁ mm	D ₂ mm	g		EAN
06600033736	1	60	19	42,5	54,0	520	5	396737
06600034136	1.1/4	64	22	51,5	54,0	690	5	396744
06600034436	1.7/16	66	22	56,5	54,0	750	5	396751
06600034536	1.1/2	66	22	59,0	54,0	800	5	396768
06600034736	1.5/8	68	24	62,5	54,0	830	5	396775
06600035036	1.13/16	72	26	69,0	60,3	1130	5	396782
06600035136	1.7/8	72	26	70,0	60,3	1250	1	396799
06600035636	2.1/4	84	36	82,5	60,3	1700	1	396805

6600-19

DIN 3129 / ISO 2725

IMPACT-Steckschlüssel-Einsätze, extra lang

Chrom Molybdän, PH = phosphatiert

IMPACT-Sockets, extra deep

Chrome molybdenum, PH = phosphated

Douilles IMPACT, extra longues

Chrome molybdène, PH = phosphatées

Llaves de vaso de IMPACTO, serie extra-larga

Cromo molibdeno, PH = fosfatado

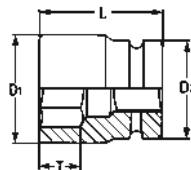

Code	ØMM	←L→ mm	T mm	D ₁ mm	D ₂ mm	g		EAN
06600192236	22	100	21	40,0	54,0	960	5	037692
06600192436	24	100	21	42,0	54,0	1000	5	037708
06600192736	27	100	23	46,0	54,0	1090	5	037715
06600193036	30	100	50	50,0	54,0	1055	5	037722
06600193236	32	100	50	52,0	54,0	1065	5	037739
06600193336	33	100	50	53,0	54,0	1095	5	037746
06600193436	34	108	35	54,0	54,0	1240	5	396812
06600193636	36	100	64	56,0	54,0	1300	5	037753
06600193836	38	100	64	58,0	54,0	1250	5	037760
06600194136	41	100	64	63,0	54,0	1266	2	037784
06600194636	46	100	62	69,0	54,0	1535	2	037791
06600195036	50	100	62	74,0	54,0	1487	2	037807
06600195536	55	100	60	80,0	54,0	1812	1	037814

6600-31

DIN 3129 / ISO 2725

IMPACT-Schraubendreher-Einsätze

Chrom Molybdän, PH = phosphatiert

für Innensechskant-Schrauben

Chrome molybdenum, PH = phosphated

IMPACT-Screwdriver-sockets for hexagon socket screws

Chrome molybdenum, PH = phosphated

Douille tournevis IMPACT pour vis six pans

Chrome molybdène, PH = phosphatées

Destornillador de IMPACTO para tornillo con hexágono interior

Cromo molibdeno, PH = fosfatado



Code	ØMM	←L→ mm	T mm	D ₂ mm	g		EAN
06600310936	19	100	20	54,0	850	5	396829
06600312036	22	100	20	54,0	920	5	396836
06600312136	24	100	20	54,0	960	5	396843
06600312236	27	100	20	54,0	1020	5	396850
06600312336	30	100	20	54,0	1090	5	396867
06600312436	32	100	20	54,0	1120	5	396874

IMPACT

6301-2 - 6601-5

DIN 3121 / ISO 1174

Verlängerungen

für IMPACT-Steckschlüssel-Einsätze
Chrom-Vanadium, PH = phosphatiert

Extension bars

for IMPACT-Sockets
Chrome-Vanadium, PH = phosphated

Rallonges

pour douilles IMPACT
Chrom-Vanadium, PH = phosphatées

Alargaderas

para llaves de vaso de IMPACTO
Cromo Vanadio, PH = fosfatado

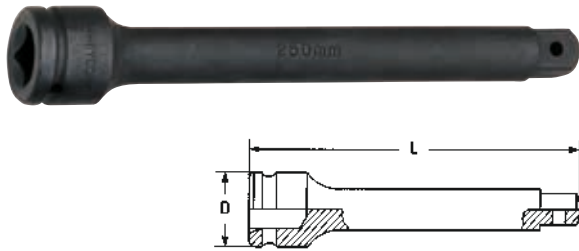

6301-2 - 6301-4

Code	No.	←L→ mm	D mm	g		EAN
06301001236	6301-2	125	25,0	240	10	036930
06301001436	6301-4	250	25,0	485	10	036954

6501-3 - 6501-5

Code	No.	←L→ mm	D mm	g		EAN
06501001336	6501-3	175	44,0	875	5	037296
06501001436	6501-4	250	44,0	1165	5	037302
06501001536	6501-5	330	44,0	1455	5	037319

6601-3 - 6601-5

Code	No.	←L→ mm	D mm	g		EAN
06601001336	6601-3	175	54,0	1440	5	037883
06601001436	6601-4	250	54,0	1950	5	037890
06601001536	6601-5	330	54,0	2485	2	037906

6301-10 - 6601-10

DIN 3121 / ISO 1174

Kugelgelenke

für IMPACT-Steckschlüssel-Einsätze
Chrom-Vanadium, PH = phosphatiert

Universal joints

for IMPACT-Sockets
Chrome-Vanadium, PH = phosphated

Rotule

pour douilles IMPACT
Chrom-Vanadium, PH = phosphatées

Articulaciones universales

para llaves de vaso de IMPACTO
Cromo Vanadio, PH = fosfatado

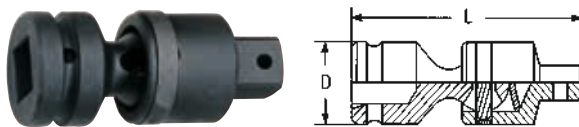

6301-10

Code	←L→ mm	D mm	g		EAN
06301001036	60	32	185	10	036916

6501-10

Code	←L→ mm	D mm	g		EAN
06501001036	105	44,0	620	5	037289

6601-10

Code	←L→ mm	D mm	g		EAN
06601001036	133	54,0	1380	5	037869

6301-22 - 6601-20

DIN 3121 / ISO 1174

Verbindungsstücke

für IMPACT-Steckschlüssel-Einsätze
Chrom-Vanadium, PH = phosphatiert

Converters

for IMPACT-Sockets
Chrome-Vanadium, PH = phosphated

Réducteurs/Augmentateurs

pour douilles IMPACT
Chrom-Vanadium, PH = phosphatées

Reductores/Amplidores

para llaves de vaso de IMPACTO
Cromo Vanadio, PH = fosfatado



6301-22

Code	No.	■	←L→ mm	D mm	g		EAN
06301002236	6301-22	3/4	48	30	160	10	036978

6501-20 - 6501-22

Code	No.	■	←L→ mm	D mm	g		EAN
06501002036	6501-20	1/2	56	44,0	310	10	037326
06501002236	6501-22	1	63	44,0	400	10	037340

6601-20

Code	■	←L→ mm	D mm	g		EAN
06601002036	3/4	75	54,0	660	5	037920

6301-40-1 - 6601-40

DIN 3129 / ISO 2725

Sicherungs-Gummiringe

für IMPACT-Steckschlüssel-Einsätze

ST = standardmäßig (Gummi, schwarz)

• Sicherungs-Gummiringe und Sicherungs-Stifte gehören nicht zum Lieferumfang der IMPACT-Steckschlüssel-Einsätze sowie Zubehörteile und müssen gesondert bestellt werden

Retaining rings

for IMPACT-Sockets

ST = standard, (rubber, black)

• Retaining rings and pins are not included with the IMPACT-Sockets and accessories and need to be ordered separately

Bagues de verrouillage

pour douilles IMPACT

ST = standard, (caoutchouc, noir)

• Les bagues et goupilles caoutchouc de verrouillage ne font pas partie du programme des douilles et accessoires IMPACT et doivent être commandées séparément

Arandelas de seguridad

para llaves de vaso de IMPACTO

ST = estándar, (caucho negro)

• Las arandelas y los pasadores de seguridad no están incluidos en el suministro de llaves de vaso y accesorios de IMPACTO, por lo que han de pedirse por separado

Code	No.	für/for	MM	g		EAN
06301104000	6301-40-1	1/2	4 x 19	1	20	036992
06301204000	6301-40-2	1/2	4 x 24	2	20	037012
06501004000	6501-40	3/4	5 x 36	3	20	037357
06601004000	6601-40	1	7 x 45	8	20	037944



6301-41-1 - 6601-41

DIN 3129 / ISO 2725

Verbindungsstifte

für IMPACT-Steckschlüssel-Einsätze

PH = phosphatiert

• Sicherungs-Gummiringe und Sicherungs-Stifte gehören nicht zum Lieferumfang der IMPACT-Steckschlüssel-Einsätze sowie Zubehörteile und müssen gesondert bestellt werden

Retaining pins

for IMPACT-Sockets

PH = phosphated

• Retaining rings and pins are not included with the IMPACT-Sockets and accessories and need to be ordered separately

Goupilles de verrouillage

pour douilles IMPACT

PH = phosphatées

• Les bagues et goupilles caoutchouc de verrouillage ne font pas partie du programme des douilles et accessoires IMPACT et doivent être commandées séparément

Pasadores de seguridad

para llaves de vaso de IMPACTO

PH = fosfatado

• Las arandelas y los pasadores de seguridad no están incluidos en el suministro de llaves de vaso y accesorios de IMPACTO, por lo que han de pedirse por separado

Code	No.	für/for	MM	g		EAN
06301104136	6301-41-1	1/2	3 x 20	1	20	037005
06301204136	6301-41-2	1/2	3 x 25	2	20	037029
06501004136	6501-41	3/4	4 x 35	4	20	037364
06601004136	6601-41	1	5 x 45	7	20	037951



IMPACT

6700

IMPACT Werkzeuggarnitur für Druckluftantrieb, 45-tlg.

- Neueste Generation von Impact-Einsätzen
- Kostenreduzierung und optimale Ressourcenschonung durch Austauschbarkeit der Bits
- Mehrfache Kugelarretrierung
- Sicherer und passgenauer Halt
- Justierbarer Druckbolzen
- Optimale Anpassung der Aufnahme an die Bits
- Bitschonende Konstruktion für optimale Kraftübertragung
- Hohe Standzeit und Langlebigkeit der Bits
- Hochwertiger Chrom-Molybdän Stahl
- Passgenaue Schaumstoffeinlage im robusten Metallkasten

IMPACT Tool set for operation with compressed air, 45 pcs.

- Latest Generation of IMPACT-Sockets
- Cost reduction and optimum resource conservation through exchangeability of bits
- Multiple ball stop
- Secure and accurate locking
- Adjustable pressure bolt
- Optimum adaption of the holder to the bits
- Bit preserving design for optimum power transmission
- High durability of the bits
- High Grade Chromium Molybdenum Steel
- Accurately fitting foam inlay in a sturdy metal box

Jeu d'outil IMPACT pour fonctionnement avec air comprimé - 45 pièces

- Dernière génération de douilles impact
- Réduction des coûts grâce à l'interchangeabilité des embouts
- Arrêt multiple à billes
- Blocage sécurisé et exacte
- Goupille à pression réglable
- Adaptation optimale du porte-embouts pour une transmission de puissance optimale
- Haute durabilité et longévité des embouts
- Acier chromé molybdène haute qualité
- Insert en mousse en robuste boîtier métallique

Juego de herramientas de IMPACTO para accionamiento con aire comprimido, de 45 piezas

- Última generación de llaves de IMPACTO
- Reducción de costos y óptimo ahorro de energía, gracias a la intercambiabilidad de las puntas
- Sujeción por bolas múltiples
- Sujeción firme y precisa
- Perno de presión ajustable
- Óptima adaptación de la sujeción a las puntas
- Diseño adecuado para óptima transmisión de la fuerza
- Larga duración de las puntas
- Acero al cromo molibdeno
- Cama de polietileno en caja metálica resistente

Code	No.	tlg./pcs.	g		EAN
06700904200	6700	45	3900	1	386998

enthaltend/containing			
Stck./pcs.	Artikel/article	←L→ mm	Maße/dimensions
			3/8"x10 1/2"x10 1/2"x14
	RI	30 75	5/6/7/8/10/12 9/10/13/14
	M	30 75	5/6/8/10 12/14
	M	75	16
	HW	30 75	4/5/6/7/8/10/12 13/14/17/19
	TX	30 75	20/25/30/40/45 40/55/60/90/100
	TTX	75	70/80

Ersatzteile/Spare parts

Code	←L→ mm		Code	←L→ mm	
06740001036	3/8"x10	1	06715364005	75 TX40	1
06750001036	1/2"x10	1	06715365505	75 TX55	1
06750001436	1/2"x14	1	06715331205	75 M12	1
06710362005	30 TX20	1	06715340905	75 RI9	1
06710362505	30 TX25	1	06715341005	75 RI10	1
06710363005	30 TX30	1	06720360605	75 TX60	1
06710364005	30 TX40	1	06720360905	75 TX90	1
06710364505	30 TX45	1	06720361005	75 TX100	1
06710330505	30 M5	1	06720360705	75 TTX70	1
06710330605	30 M6	1	06720360805	75 TTX80	1
06710330805	30 M8	1	06720331405	75 M14	1
06710331005	30 M10	1	06720331605	75 M16	1
06710340505	30 RI5	1	06720341305	75 RI13	1
06710340605	30 RI6	1	06720341405	75 RI14	1
06710340705	30 RI7	1	06720301305	75 13	1
06710340805	30 RI8	1	06720301405	75 14	1
06710341005	30 RI10	1	06720301705	75 17	1
06710341205	30 RI12	1	06720301905	75 19	1
06710300405	30 4	1			
06710300505	30 5	1			
06710300605	30 6	1			
06710300705	30 7	1			
06710300805	30 8	1			
06710301005	30 10	1			
06710301205	30 12	1			





MADE IN GERMANY

DREHMOMENTSCHLÜSSEL

- Genauigkeit $\pm 3\%$ vom Skalenwert (in Betätigungsrichtung)
- Sicher:
Haptisch (Kurzwegauslösung)
Akustisch (Knickelement)
- Einstellen des gewünschten Drehmoment-Wertes schnell und sicher durch Drehen des Griffes
- Anwenderfreundliche, ergonomische Umschaltknarre
- Vierkant nach DIN 3120, ISO 1174-1, DIN EN ISO 6789:2003 (D)
- Chromoberfläche des Rohres: matt
- Skalengehäuse mit Doppelskala: Nm (lbf.ft)
- Sichere Verriegelung des Handgriffes durch Drehkranz – keine Klemmgefahr!
- Made in Germany
- Mit Seriennummer und Zertifikat
- Unverzichtbar für kontrollierten Drehmoment-Anzug



$\frac{1}{4}''$ $\frac{3}{8}''$ $\frac{1}{2}''$ $\frac{3}{4}''$

TORQUE WRENCHES

- Release accuracy tolerance $\pm 3\%$ of scale value (in direction of actuation)
- Safe torque release:
Palpable (close gap release)
Audible („click“ sound)
- Easy and safe adjustment of the desired torque value by turning the handle
- User-friendly, ergonomic reversible ratchet
- DIN EN ISO 6789:2003, Square according to DIN 3120, ISO 1174-1
- Chrome surface of the tube: matt
- Scale housing with double scale: Nm (lbf.ft)
- Safety locking of the handle due to green rotary assembly - no risk of injury!
- Made in Germany
- With serial number and certificate
- Indispensable for the torque controlled screw tightening

CLÉS DYNAMOMÉTRIQUES

- Précision de $\pm 3\%$ de l'échelle (dans le sens de l'actionnement)
- Un déclenchement sûr:
au toucher (déclenchement à course courte)
sonore (signal de clic)
- Sélection simple et sûre de la valeur souhaitée par rotation du manche
- Cliquet ergonomique et convivial
- Forme carrée conformément aux normes DIN 3120, ISO 1174-1, DIN EN ISO 6789:2003 (D)
- Surface chromée du tube: matte
- Boîtier à double échelle: Nm (lbf.ft)
- Blocage sûr de la poignée grâce à une couronne d'orientation – pas de risque de coincement!
- Made in Germany
- Numéro de série et certificat
- Un outil incontournable pour un serrage au couple contrôlé

LLAVE DINAMOMÉTRICA

- Precisión del $\pm 3\%$ del valor ajustado en la escala (en dirección de acción)
- Seguridad:
Háptica (salto de recorrido corto)
Acústica (elemento de apriete)
- Ajuste rápido y seguro del valor del par de torsión con solo girar el mango
- Carraca ergonómica y fácil de utilizar
- Cuadrado según DIN 3120, ISO 1174-1, DIN EN ISO 6789:2003 (D)
- Tubo con superficie cromada: mate
- Carcasa de la escala con escala doble: Nm (lbf.ft)
- Bloqueo seguro en el mango con una corona giratoria: sin riesgo de atascamiento
- Made in Germany
- Con número de serie y certificado
- Esencial para lograr pares de apriete controlados



751 - 757

Drehmomentschlüssel

Mit Hebelumschaltknarre.
Lieferung in stabilem Hexa-Drehpack.

Torque wrenches



With reversible ratchet.
Delivery in sturdy Hexa plastic box.

Clés dynamométriques

Avec Cliquet réversible à levier.
Livraison dans une solide boîte en plastique Hexa.

Llaves dinamométricas

Con Carraca reversible.
Entrega en robusta caja de plástico Hexa.

Code	No.	■	Nm		$\leftarrow L \rightarrow$ mm			EAN
00751000080	751	1/4"	5 - 25	0,25 Nm	275	520	1	415001
00752000080	752	3/8"	10 - 60	0,50 Nm	355	760	1	415018
00756000080	756	1/2"	60 - 320	2,00 Nm	621	1740	1	415025
00757000080	757	3/4"	300 - 850	2,50 Nm	1270	6600	1	415032



664 - 666

Drehmomentschlüssel mit eingebauter Durchstecknarre

Verwendung für Rechts- und Linksgewinde, Einstellung durch Rändelschraube am Griffende; automatische Auslösung mit akustischem und fühlbarem Signal bei Erreichen des eingestellten Drehmoments.

Genauigkeitsgrad $\pm 4\%$
CPP = verchromt, ganz poliert

Torque wrenches with built-in push-thru ratchet

For right and left hand threads; setting, with knurled knob at end of handle; automatic release with audible and tactile signal when set torque is reached. Release accuracy $\pm 4\%$
CPP = chromium plated, fully polished

Clés dynamométriques avec cliquet



À utiliser pour pas à droite et à gauche, réglage par vis moletée en bout de poignée, déclenchement automatique avec signal acoustique et sensitif dès que le couple programmé est atteint.

Degré de précision: $\pm 4\%$
CPP = chromées, entièrement polies

Llaves dinamométricas con carraca de cuadradillo pasante

Con carraca de cuadradillo pasante para giro a derecha e izquierda, ajuste mediante tuerca en el extremo del mango de disparo con señal acústica y perceptible al alcanzar el par de apriete.

Grado de precisión $\pm 4\%$
CPP = cromado, enteramente pulido espejo

Code	No.	Skaleneinteilung graduation of scale Nm kpm ft./lbs.	$\leftarrow L \rightarrow$ mm			EAN
00664000083	664	15-70 1,5-7 10-50	395-430	1110	1	015522
00665000083	665	30-140 3-14 20-100	485-520	1365	1	015553
00666000083	666	60-280 6-28 40-200	520-555	1490	1	015560

Zur Entlastung der Messfeder von allen Drehmomentschlüsseln muß nach Gebrauch immer der kleinste Wert eingestellt werden.

To discharge the measuring spring, all Torque wrenches must always be reset to their lowest value.

Après utilisation, toujours ramener le réglage de couple de toutes les clés dynamométriques à leur valeur la plus basse, afin de délester le ressort de pression.

Una vez terminado el trabajo y para evitar una sobrecarga del resorte, conviene ajustar todas las llaves dinamométricas al valor más bajo de la escala.



3/8" 664 · 30 Zähne/teeth · Meßbereich/torque range:
Nm 15 - 70, kpm 1,5 - 7, ft./lbs. 10 - 50



1/2" 665 · 30 Zähne/teeth · Meßbereich/torque range:
Nm 30 - 140, kpm 3 - 14, ft./lbs. 20 - 100



1/2" 666 · 30 Zähne/teeth · Meßbereich/torque range:
Nm 60 - 280, kpm 6 - 28, ft./lbs. 40 - 200

695-1



Digitaler Drehmomentadapter und Drehwinkel-messgerät Drehmomentadapter für 40 - 200 Nm

- Ermöglicht das Messen eines Drehmoments und eines Drehwinkels mit jeder 1/2" Narnre
- Voreinstellen von bis zu 10 Messwerten möglich
- Speicherplatz für bis zu 50 Messwerte
- Drehwinkelbereich größer als >360°
- Akustische und optische Signalisierung beim Annähern und Erreichen des voreingestellten Wertes
- Präzise Messgenauigkeit ±2%
- Einstellbare Drehmomenteinheiten: Nm, in/lb, ft/lb, kg/cm

Digital torque angle applicator for 40 - 200 Nm

- Allows the measurement of a torque and a rotation angle with any 1/2" ratchet
- Presetting for up to 10 measured values
- Memory for up to 50 measured values
- Torque Angle Measurement 360° and more
- Audible and visual signal when approaching and reaching the preset value
- Accuracy ±2%
- Adjustable Torque Units: Nm, in/lb, ft/lb, kg/cm

Adaptateur dynamométrique Digital et Dispositif de serrage angulaire, Adaptateur de couple pour 40 à 200 Nm

- Permet la mesure du couple et de l'angle de rotation à chaque 1/2" à cliquet
- Préréglage jusqu'à 10 lectures possibles
- Mémoire jusqu'à 50 lectures
- Zone angulaire de rotation supérieur à >360°
- Les valeurs mesurées peuvent être exporté vers excel par logiciel inclus pour traitement
- Signalisation sonore et visuelle à l'approche de la valeur définie
- Précision de la mesure précise de ±2%
- Unités de couple réglables: Nm, in/lb, ft/lb, kg/cm

Adaptador dinámico digital y goniómetro Adaptador dinámico para 40 - 200 Nm

- Permite la medición del par y del ángulo de torsión con cualquier tipo de carraca de 1/2"
- Posibilidad de preajuste de 10 valores de medición
- Capacidad de memoria de hasta 50 valores de medición
- Posibilidad de ángulos de medición superiores a 360
- Precisión de medición de ±2%
- Unidades de par variables: Nm, in/lb, ft/lb, kg/cm

Code	°	mm	g		EAN
00695101000	0-360	82	260	1	371673

Messwerte können durch mitgelieferte Software zur weiteren Bearbeitung in Excel exportiert werden. Schaltet bei Nichtgebrauch nach 5 min. automatisch ab um Strom zu sparen. Im hochwertigen Metallkasten mit 2-K Schaumstoffeinlage, 250 x 130 x 90 mm.

Measured values can be exported for further processing in excel via supplied software. Automatic turn off after 5 min when it's not in use, to save power. In high quality metal case with foam insert, 250 x 130 x 90 mm.

Les résultats peuvent être exportés grâce au logiciel livré avec le produit pour un travail avec Excel. S'éteint automatiquement après 5 minutes de non utilisation, pour économiser l'énergie. En boîtier métallique de haute qualité avec insert en mousse, 250 x 130 x 90 mm.

Mediante un software incluido, se pueden trasvasar las mediciones a Excel para su procesamiento posterior. Señales acústicas y visuales al aproximar o alcanzar el valor preajustado. Desconexión automática a los 5 minutos de terminar su uso. En caja metálica con bandeja de polispam de 2 componentes, 250 x 130 x 90 mm.



24-Stunden
Kalibrierungsservice - Austauschservice -

24-hours
calibration
- exchange service

Radmutter- und Kreuzschlüssel für

- PKW und leichte Nutzfahrzeuge
- LKW und schwere Nutzfahrzeuge

Wheel nut and four way rim wrenches for

- motor cars and light duty commercial vehicles
- trucks and heavy duty commercial vehicles

Clés à écrous de roues et clés en croix pour

- voitures et véhicules utilitaires légers
- camions et véhicules utilitaires lourds

Llaves para ruedas y llaves en cruz para

- automóviles y vehículos ligeros
- camiones y vehículos pesados

501

Radmutternschlüssel

PH = phosphatiert
zu verwenden mit Drehstange HEYCO 900-18

Wheel nut wrenches

PH = phosphated
to be used with tommy bar HEYCO 900-18

Clés à écrous de roues

PH = phosphatées
à utiliser avec la broche HEYCO 900-18

Llaves para ruedas

PH = fosfatado
para utilizar con bandeador HEYCO 900-18



Code	MM	←L→ mm	D ₁ mm	D ₂ mm	g		EAN
00501242736*	MM 24 x 27	380	36,0	40,0	1200	1	013962
00501273236*	MM 27 x 32	380	40,0	46,0	1320	1	013979
00501242736*	AF 15/16 x 1.1/16	380	36,0	40,0	1200	1	013962
00501273236*	AF 1.1/16 x 1.1/4	380	40,0	46,0	1320	1	013979

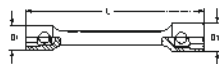

503

Radmutternschlüssel

PH = phosphatiert
zu verwenden mit Drehstange HEYCO 900-18

Wheel nut wrenches

PH = phosphated
to be used with tommy bar HEYCO 900-18

Clés à écrous de roues

PH = phosphatées
à utiliser avec la broche HEYCO 900-18

Llaves para ruedas

PH = fosfatado
para utilizar con bandeador HEYCO 900-18



Code	AF	←L→ mm	D ₁ mm	D ₂ mm	g		EAN
00503665636	AF 1.1/8 x 13/16 □ x 1.1/2	400	44,0	52,0	1450	1	014020
00503666436	AF 1.5/16 x 13/16 □ x 1.1/2	400	46,0	52,0	1460	1	014037

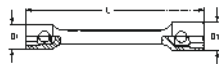

600-10

DIN 3191 / ISO 6788

Kreuzschlüssel

Chrom-Vanadium, CP = verchromt, Köpfe poliert

Four way rim wrench

Chrom-Vanadium, CP = chromium plated, polished heads

Clés en croix

Chrom-Vanadium, CP = chromées, têtes polies

Llaves en cruz

Cromo Vanadio, CP = cromado, cabeza pulida espejo



Code	MM	←L→ mm	g		EAN
00600001082	MM 17 x 19 x 22 x AF 13/16	380	1170	1	015188



610

DIN 3191 / ISO 6788

Kreuzschlüssel

CL = chromfarbig

Four way rim wrenches

CL = chrome coloured

Clés en croix

CL = couleur de chrome

Llaves en cruz

CL = cromatizado



Code	No.	MM	←L→ mm	g		EAN
00610001070	● 610-1	MM 24 x 27 x 30 x 32	700	4650	1	015409
00610010070	● 610-10	MM 24 x 27 x 32 x 3/4"	700	4800	1	323528
00610003170	* 610-31	MM 19 x 22 x 24 x 27	600	2380	1	015423

● mit zusätzlichem Innenvierkant AF 13/16
with additional square socket, avec carré intérieur additionnel,
adicionalmente con cuadradillo hembra
* Chrom-Vanadium
Chrome-Vanadium, Chrome-Vanadium, Cromo Vanadio

530

Doppelsteckschlüssel

Chrom-Vanadium, C = verchromt
massiv geschmiedet, mit Sechskantschaft

Double ended socket wrenches

Chrome-Vanadium, C = chromium plated
solid wrought, with hexagon shaft

Clés en tube

Chrome-Vanadium, C = chromées
forgées dans la masse avec corps, 6 pans et possibilité de broche

Llaves de tubo

Cromo Vanadio, C = cromado
cabezas pulidas espejo, forjadas, cuerpo hexagonal

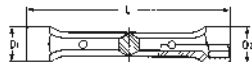

Code	MM	←L→ mm	D ₁ mm	D ₂ mm	passende Drehstange to be used with tommy bar	g		EAN
00530060780	6 x 7	103	10,0	11,0	900-3	30	10	310689
00530080980	8 x 9	108	12,5	13,5	900-3	55	10	310696
00530101180	10 x 11	120	15,0	16,0	900-4	80	10	310702
00530121380	12 x 13	138	17,3	18,8	900-5	125	10	310726
00530141580	14 x 15	143	19,8	21,1	900-6	145	5	310733
00530161780	16 x 17	153	22,4	23,9	900-6	150	5	310740
00530181980	18 x 19	163	25,2	26,2	900-8	240	5	310757
00530202280	20 x 22	173	27,6	30,1	900-8	300	5	310764
00530212380	21 x 23	183	28,8	30,8	900-10	370	5	310771
00530242680	24 x 26	193	32,5	34,7	900-10	420	5	310788
00530242780	24 x 27	193	32,6	36,6	900-12	455	5	310795
00530252880	25 x 28	203	34,0	37,0	900-12	535	5	310818

Die benötigten Drehstifte finden Sie auf S. 99
The required rotary pins can be found on p. 99

B 530

Doppelsteckschlüssel-Sätze

mit Drehstange, in Metallkästen
B 530-8-M = 318 x 119 x 49 mm

Double ended socket wrench sets

with tommy bar, in metal cases
B 530-8-M = 318 x 119 x 49 mm

Jeux de clés en tube

avec broche, en coffret métallique
B 530-8-M = 318 x 119 x 49 mm

Juegos de llaves de tubo

con bandeador, en cajas metálicas
B 530-8-M = 318 x 119 x 49 mm



Code	No.	MM	= 1	g	EAN
00530644080	B 530-8-M	6 x 7 8 x 9 10 x 11 12 x 13 14 x 15 16 x 17 18 x 19 20 x 22 + No. 1360		2350	310863

K 530

Doppelsteckschlüssel-Sätze

Double ended socket wrench sets

Jeux de clés en tube

Juegos de llaves de tubo



Code	No.	MM				=1	g	EAN
00530944080	K 530-8-M	6 x 7	8 x 9	10 x 11	12 x 13	1145	310894	
		14 x 15	16 x 17	18 x 19	20 x 22			

896

DIN 896 B

Rohrsteckschlüssel

C = verchromt

Betätigung mit Drehstange HEYCO 900

Double ended tubular socket wrenches

C = chromium plated

to be used with tommy bar HEYCO 900

Clés en tube

C = chromées

à utiliser avec la broche HEYCO 900

Llaves de tubo

C = cromado

a usar con bandeador HEYCO 900



Code	MM	←L→ mm	passende Drehstange to be used with tommy bar	g		EAN
00896060780	6 x 7	100	900-5	25	10	099201
00896080980	8 x 9	100	900-6	30	10	099218
00896081080	8 x 10	120	900-6	45	10	099225
00896101180	10 x 11	120	900-6	45	10	020458
00896121380	12 x 13	140	900-8	65	10	099249
00896141580	14 x 15	140	900-8	80	10	099263
00896161780	16 x 17	150	900-10	130	5	099287
00896171980	17 x 19	160	900-12	150	5	099294
00896181980	18 x 19	160	900-12	150	5	099300
00896202280	20 x 22	170	900-12	220	5	099317
00896212380	21 x 23	170	900-14	265	5	099324
00896242680	24 x 26	185	900-14	300	5	099348
00896242780	24 x 27	185	900-14	300	5	099355
00896252880	25 x 28	205	900-16	370	5	099362
00896303280	30 x 32	205	900-16	410	5	099393
00896323680	32 x 36	225	900-18	540	1	099416
00896364180	36 x 41	225	900-18	590	1	099423
00896414680	41 x 46	245	900-20	835	1	099430
00896465080	46 x 50	245	900-20	1340	1	099447
00896505580	50 x 55	245	900-20	1815	1	099454
00896556080	55 x 60	280	900-20	2130	1	099461

K 896

DIN 896 B

Rohrsteckschlüssel-Sätze

Double ended tubular socket wrench sets

Jeux de clés en tube

Juegos de llaves de tubo



Code	No.	MM				=1	g	EAN
00896944080	K 896-8-M	6 x 7	8 x 9	10 x 11	12 x 13	835	099782	
		14 x 15	16 x 17	18 x 19	20 x 22			
00896947080	K 896-12-M	6 x 7	8 x 9	10 x 11	12 x 13	2075	099799	
		14 x 15	16 x 17	18 x 19	20 x 22			
		21 x 23	24 x 27	25 x 28	30 x 32			

R 896-9

DIN 896 B

Rohrsteckschlüssel-Sätze, 9-tlg.

Double ended tubular socket wrench sets, 9 pcs.

Jeux de clés en tube, 9 pces.

Juegos de llaves de tubo, 9 pzs.



Code	No.	MM				=1	g	EAN
00896744080	R-896-9-M	6 x 7	8 x 9	10 x 11	12 x 13	1071	356274	
		14 x 15	16 x 17	18 x 19	20 x 22			

900

DIN 900

Drehstangen

C = verchromt

Tommy bars

C = chromium plated

Broches

C = chromées

Bandeadores

C = cromado



Code	No.	←L→ mm	∅ mm	g		EAN
0090000305	900-3	80	3,2	8	10	020502
0090000405	900-4	100	4,0	10	10	020519
0090000505	900-5	125	5,0	20	10	020526
0090000605	900-6	160	6,0	35	10	020540
0090000805	900-8	180	8,0	75	10	020564
00900001005	900-10	200	10,0	125	10	020588
00900001205	900-12	250	12,0	225	10	020601
00900001405	900-14	320	14,0	390	5	020625
00900001605	900-16	400	16,0	630	5	020656
00900001805	900-18	500	18,0	1000	5	020670
00900002005	900-20	630	20,0	1560	5	020694

1360

Drehstange

Chrom-Vanadium, C = verchromt
abgestuft

Tommy bar

Chrome-Vanadium, C = chromium plated
in steps

Broches

Chrome-Vanadium, C = chromées
étagées

Bandeadores

Cromo Vanadio, C = cromado
escalonados



Code	←L→ mm	∅ mm	g		EAN
91361024080	240	3,2 5 6 8 10 12	160	10	028010

541

DIN 312

Steckschlüssel

Chrom-Vanadium, CPP = verchromt, ganz poliert
mit schlagfestem Kunststoff-Heft

Nut spinners

Chrome-Vanadium, CPP = chromium plated,
fully polished with shockproof plastic handle

Clés à douilles emmanchées

Chrome-Vanadium, CPP = chromées entièrement polies
manche en matière plastique incassable

Llaves de vaso con mango

Cromo Vanadio, CPP = cromado, enteramente pulido
espejo con mango de plástico antichoque

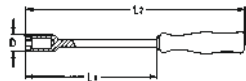

Code	∅MM	L ₁ mm	L ₂ mm	D mm	g		EAN
00541000583	5	120	220	8,0	85	10	014617
00541005583	5,5	120	220	8,0	85	10	014761
00541000683	6	120	220	9,0	90	10	014624
00541000783	7	120	220	11,0	95	10	014631
00541000883	8	120	225	12,0	120	10	014648
00541001083	10	125	230	14,0	170	10	014662

545

Steckschlüssel

Chrom-Vanadium, ST = standardmäßig
flexibler Schaft, mit Kunststoffheft

Nut spinners

Chrome-Vanadium, ST = standard
flexible shaft, with shockproof plastic handle

Clés à douilles emmanchées

Chrome-Vanadium, ST = standard
avec tige flexible et manche plastique

Llaves de vaso con mango

Cromo Vanadio, ST = standard
varilla flexible, mango de plástico

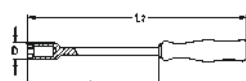

Code	∅MM	L ₁ mm	L ₂ mm	D mm	g		EAN
00545000600	6	150	250	11	140	10	099133
00545000700	7	150	250	11	140	10	099744

WERKZEUG-SORTIMENTE UND BEHÄLTNISSE

TOOL ASSORTMENTS AND RECEPTACLES

102-116 Seite/page

Werkzeugsortimente in Behältnissen
Tool assortments in receptacles

117-145 Seite/page

Werkstattwagen, leer und bestückt
workshop trolley, empty and assembled





KFZ-WERKSTATT UND WARTUNG

MOTOR MECHANIC WORKSHOP AND MAINTENANCE
RÉPARATION ET ENTRETIEN D'AUTOMOBILE
REPARACIÓN Y MANTENIMIENTO DEL AUTOMÓVIL

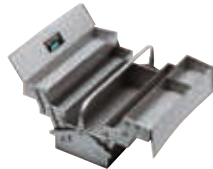

1000



1002-100



1101*

910-M
00910000282

1000-914-M
01000091482

1002-910-M
01002910282

910-AF
00910000382

1000-915-M
01000091582

1002-910-AF
01002910382

911-M
00911000282

1101-911-M
01101911282

911-AF
00911000382

1101-911-AF
01101911382

* HEYCO 1101 ist nur mit dem vorgegebenen Sortiment HEYCO 911 bestückbar
can only be equipped with assortment HEYCO 911
ne peut être équipée qu'avec la sélection HEYCO 911
sólo se suministra con el conjunto HEYCO 911

BAUSTELLE, LKW, LANDMASCHINEN

TRUCKS, BUILDING AND AGRICULTURAL EQUIPMENT
ENGINS DE CHANTIER, CAMIONS, MACHINES AGRICOLES
MAQUINARIA DE CONSTRUCCIÓN, CAMIONES, MAQUINARIA AGRÍCOLA



1128



1135

933-M
00933000282

1128-933-M
01128933282

1135-933-M
01135933282

933-AF
00933000382

1128-933-AF
01128933382

1135-933-AF
01135933382

MECHANIK, INDUSTRIE UND WARTUNG

MECHANICS, INDUSTRY AND MAINTENANCE
MÉCANIQUE, INDUSTRIE ET ENTRETIEN
TALLER MECÁNICO, INDUSTRIA Y MANTENIMIENTO



1128

942-M
00942000282

1128-942-M
01128942282

942-AF
00942000382

1128-942-AF
01128942382

943-M
00943000282

1128-943-M
01128943282

943-AF
00943000382

1128-943-AF
01128943382

WERKZEUGSORTIMENTE IN BEHÄLTNISSSEN

TOOL ASSORTMENTS IN RECEPTACLES

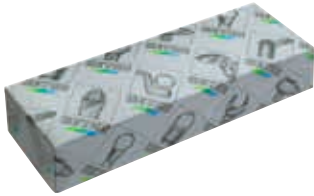

910 - 943

Werkzeugsortimente in Kartonagen

Tool assortments (in cardboard cartons only)

Sélections d'outillage en Carton

Conjuntos de herramientas en cartones

Code	No.	tlg. pcs.				EAN
00910000282	910-M	88	104/105	8380	1	020762
00910000382	910-AF	88	104/105	9910	1	020779
00911000282	911-M	112	106/107	16900	1	020786
00911000382	911-AF	112	106/107	17480	1	020793
00933000282	933-M	110	108/109	25310	1	021028
00933000382	933-AF	108	108/109	26550	1	021035
00942000282	942-M	140	110/111	20140	1	021134
00942000382	942-AF	135	110/111	20200	1	021141
00943000282	943-M	165	112/113	30350	1	021158
00943000382	943-AF	156	112/113	33290	1	021165



1002-910 - 1135-933

Werkzeugsortimente in Behältnissen

Tool assortments (in receptacles)

Sélections d'outillage avec contenants

Conjuntos de herramientas en contenedores

Code	No.	tlg. pcs.			EAN
in Kästen/in tool boxes					
01002910282	1002-910-M	89	104/105	1	021349
01002910382	1002-910-AF	89	104/105	1	021356
01000091482	1000-914-M	99	114	1	392777
01000091582	1000-915-M	99	115	1	392791
in Schränken/in wall cabinets					
01101911282	1101-911-M	113	106/107	1	021776
01101911382	1101-911-AF	113	106/107	1	021783
in Werkstattwagen/in workshop trolleys					
01128933282	1128-933-M	111	108/109	1	142570
01128933382	1128-933-AF	109	108/109	1	142587
01128942282	1128-942-M	141	110/111	1	142648
01128942382	1128-942-AF	136	110/111	1	142631
01128943282	1128-943-M	166	112/113	1	346985
01128943382	1128-943-AF	157	112/113	1	346992
in Truhen/in tool chests					
01135933282	1135-933-M	111	108/109	1	022360
01135933382	1135-933-AF	109	108/109	1	022377

910

KFZ-Werkstatt und Wartung

HEYCO-Werkzeugsortimente
Kundendienst-Sortiment

Motor mechanic workshop and maintenance



HEYCO-Tool assortments
Service assortment





Réparation et entretien d'automobile

HEYCO-Sélection d'outillage
Sélection d'entretien

Reparación y mantenimiento del automóvil

HEYCO Conjuntos de herramientas
Conjunto para mantenimiento





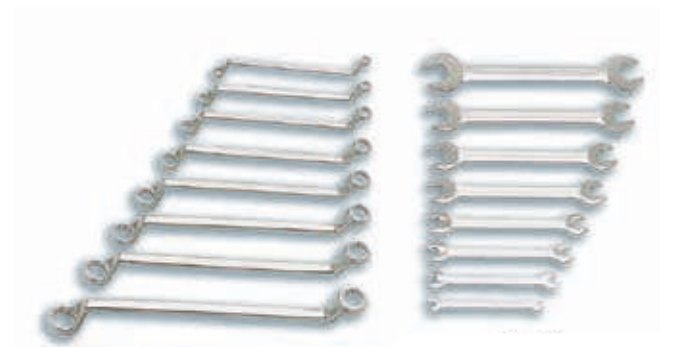
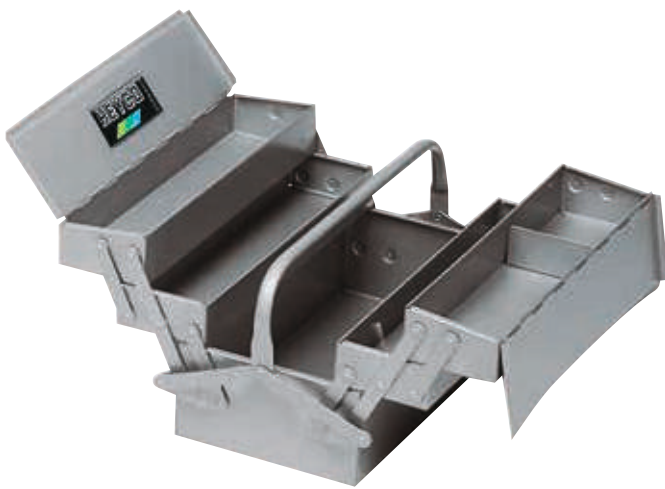









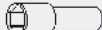





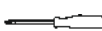

Code	No.	Stck. pcs.			EAN
00910000282	910-M	88	8380	1	020762
00910000382	910-AF	88	9910	1	020779

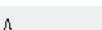
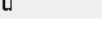
Code	No.	Stck. pcs.	Behältnis receptacle			EAN
01002910282	1002-910-M	89	 1002-100	13820	1	021349
01002910382	1002-910-AF	89	 1002-100	15350	1	021356

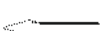
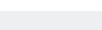
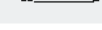

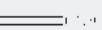
enthaltend / containing

★ = 910-M ☆ = 910-AF

Stck. pcs.	Artikel article	No.	M	AF	Maße sizes
8		350 CP	★	☆	MM 6 x 7 8 x 9 10 x 11 12 x 13 14 x 15 16 x 17 18 x 19 20 x 22 AF 1/4 x 5/16 3/8 x 7/16 1/2 x 9/16 5/8 x 11/16 3/4 x 25/32 13/16 x 7/8 15/16 x 1 1.1/16 x 1.1/4
8		475 CP	★	☆	MM 6 x 7 8 x 9 10 x 11 12 x 13 14 x 15 16 x 17 18 x 19 20 x 22 AF 1/4 x 5/16 3/8 x 7/16 1/2 x 9/16 5/8 x 11/16 3/4 x 25/32 13/16 x 7/8 15/16 x 1 1.1/16 x 1.1/4
18		50-12 CPP	★	☆	MM 12 13 14 15 16 17 18 19 20 21 22 23 24 26 27 28 30 32
18	☆			AF 3/8 7/16 1/2 9/16 19/32 5/8 11/16 3/4 25/32 13/16 7/8 15/16 31/32 1 1.1/16 1.1/8 1.3/16 1.1/4	
1		50-00-1 CP	★	☆	270 mm
1		50-03 CPP	★	☆	300 mm
1		50-19-3 CP	★	☆	MM 16 AF 5/8
1		50-05 CPP	★	☆	250 mm
1		300 CP	★	☆	240 mm
1		1200 CPD	★	☆	180 mm
1		1208 CPD	★	☆	200 mm
1		1212 CPD	★	☆	160 mm
1 (8)		K 1340-8 B	★	☆	MM 2 2,5 3 4 5 6 8 10 AF 1/16 5/64 3/32 1/8 5/32 3/16 7/32 1/4
2				☆	PH No. 1 2
1		1435 C	★	☆	100 x 3 mm
1		1445 C	★	☆	25 x 6,5 mm
2		1437 C	★	☆	100 x 5,5 150 x 8
1		1483 N	★	☆	125 x 5,5 mm
1		1520 LS	★	☆	300 g
1		1522 AS	★	☆	3/4 lb.
1		1555 LS	★	☆	150 x 18 mm
1		1560 LS	★	☆	150 x 6 mm
1		1570 LS	★	☆	120 x 3 mm
1		1575 LS	★	☆	120 x 4 mm
1		1675 ST + 1681-5 ST	★	☆	250 mm
1		1679 ST + 1681-3 ST	★	☆	200 mm
6		1686-1 B	★	☆	150 mm
1 (6)		1689 B	★	☆	150 mm ● ▲ ■ □
1		1759 ST	★	☆	150 mm
1		1814-2 P/N	★	☆	13 Blatt/blades 0,05 – 1,0 mm
		1814-12 P/N	★	☆	13 Blatt/blades .002 – .035"

911

Kfz-Werkstatt und Wartung

Werkstatzschrank

Der Werkzeugschrank HEYCO 1101 ist nur mit dem vorgegebenen Sortiment HEYCO 911 bestückbar.

Motor mechanic workshop and maintenance

Workshop wall cabinet

The workshop wall cabinet HEYCO 1101 can only be equipped with assortment HEYCO 911.

Réparation et entretien d'automobile

Armoire murale

L'armoire murale HEYCO 1101 ne peut être équipée qu'avec la sélection HEYCO 911.

Reparación y mantenimiento del automóvil

Armario de herramientas de taller

El armario HEYCO 1101 sólo se suministra con el conjunto HEYCO 911.

Code	No.	Stck. pcs.			EAN
00911000282	911-M	112	16900	1	020786
00911000382	911-AF	112	17480	1	020793

Code	No.	Stck. pcs.	Behältnis receptacle			EAN
01101911282	1101-911-M	113	 1101	37900	1	021776
01101911382	1101-911-AF	113	 1101	38480	1	021783



enthaltend / containing

★ = 911-M ☆ = 911-AF

Stck. pcs.	Artikel article	No.	M	AF	Maße sizes
12		350 CP	★	☆	MM 6 x 7 8 x 9 10 x 11 12 x 13 14 x 15 16 x 17 18 x 19 20 x 22 21 x 23 24 x 27 25 x 28 30 x 32 AF 1/4 x 5/16 3/8 x 7/16 1/2 x 9/16 19/32 x 11/16 5/8 x 11/16 5/8 x 3/4 3/4 x 25/32 13/16 x 7/8 7/8 x 15/16 15/16 x 1 1 x 1.1/8 1.1/16 x 1.1/4
12		475 CP	★	☆	MM 6 x 7 8 x 9 10 x 11 12 x 13 14 x 15 16 x 17 18 x 19 20 x 22 21 x 23 24 x 27 25 x 28 30 x 32 AF 1/4 x 5/16 3/8 x 7/16 1/2 x 9/16 5/8 x 11/16 5/8 x 3/4 3/4 x 25/32 3/4 x 7/8 13/16 x 7/8 7/8 x 15/16 15/16 x 1 1 x 1.1/8 1.1/16 x 1.1/4
2		390 CP			160 mm 205 mm
18		50-12 CPP	★	☆	MM 12 13 14 15 16 17 18 19 20 21 22 23 24 26 27 28 30 32 AF 3/8 7/16 1/2 9/16 19/32 5/8 11/16 3/4 25/32 13/16 15/16 31/32 1 1.1/16 1.1/8 1.3/16 1.1/4
1		50-00-1 CP	★	☆	270 mm
1		50-03 CPP	★	☆	300 mm
1		50-04 CPP	★	☆	125 mm
1		50-05 CPP	★	☆	250 mm



enthaltend / containing				★ = 911-M	☆ = 911-AF
Stck. pcs.	Artikel article	No.	M	AF	Mafße sizes
1		50-06 CPP	★	☆	80 mm
1		50-19-3 CP	★	☆	MM 16 AF 5/8
1		600-10 CP	★	☆	MM/AF 17 x 13/16 x 19 x 22 mm
1		300 CP	★	☆	240 mm
1		320 CP	★	☆	200 mm
1		1200 CPD	★	☆	180 mm
1		1208 CPD	★	☆	200 mm
1		1212 CPD	★	☆	160 mm
1		1215 CPD	★	☆	160 mm
1		1280 N	★	☆	250 mm
1 (8)		K 1340-8 B	★	☆	MM 2 2,5 3 4 5 6 8 10 AF 1/16 5/64 3/32 1/8 5/32 3/16 7/32 1/4
3		1411 C	★	☆	PH No. 1 2 3
1		1435 C	★	☆	100 x 3 mm
1		1445 C	★	☆	25 x 6,5 mm
3		1437 C	★	☆	100 x 5,5 150 x 8 200 x 12 mm
1		1483 N	★	☆	125 x 5,5 mm
2		1500 C	★	☆	500 mm
1		1520 LS	★		300 g
1		1522 AS		☆	3/4 lb.
1		2165 ST	★	☆	∅ 32 mm
1		1555 LS	★	☆	150 x 18 mm
1		1560 LS	★	☆	150 x 6 mm
1		1570 LS	★	☆	120 x 3 mm
1		1575 LS	★	☆	120 x 4 mm
1		1675 ST + 1681-5 ST	★	☆	250 mm
1		1676 ST + 1681-5 ST	★	☆	250 mm
1		1677 ST + 1681-3 ST	★	☆	200 mm
1		1679 ST + 1681-3 ST	★	☆	200 mm
6		1686-1 B	★	☆	150 mm
1 (6)		1689 B	★	☆	150 mm ● ▲ ■ □
1		1759 ST	★	☆	150 mm
1		1782-2 ST	★	☆	250 ccm
1		1814-2 P/N	★		13 Blatt/blades 0,05 – 1,0 mm
		1814-12 P/N		☆	13 Blatt/blades .002 – .035"

933

Baustelle, LKW, Landmaschinen

LKW-Reparatur + Wartung

Trucks, building and agricultural equipment



Truck repair and maintenance







Engins de chantier, camions, machines agricoles

Sélection pour réparation et entretien de camions







Maquinaria de construcción, camiones, maquinaria agrícola

Conjunto para reparación mantenimiento de camiones

Code	No.	Stck. pcs.			EAN
00933000282	933-M	110	25310	1	021028
00933000382	933-AF	108	26550	1	021035

Code	No.	Stck. pcs.	Behältnis receptacle			EAN
01128933282	1128-933-M	111		80300	1	142570
01128933382	1128-933-AF	109		81550	1	142587
			1128			
01135933282	1135-933-M	111		46310	1	022360
01135933382	1135-933-AF	109		47550	1	022377
			1135			

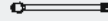

enthaltend / containing			★ = 933-M ☆ = 933-AF		
Stck. pcs.	Artikel article	No.	M	AF	Maße sizes
7		350 CP	★	☆	MM 6 x 7 8 x 9 10 x 11 12 x 13 14 x 15 16 x 17 18 x 19 AF 1/4 x 5/16 3/8 x 7/16 1/2 x 9/16 5/8 x 11/16 3/4 x 25/32 13/16 x 7/8 15/16 x 1
10		400 CP	★	☆	MM 8 9 10 11 12 13 14 17 19 22 AF 5/16 3/8 7/16 1/2 9/16 5/8 11/16 3/4 13/16 7/8
11		475 CP	★	☆	MM 6 x 7 8 x 9 10 x 11 12 x 13 14 x 15 16 x 17 18 x 19 21 x 23 22 x 24 25 x 28 27x30 mm AF 1/4 x 5/16 3/8 x 7/16 1/2 x 9/16 5/8 x 11/16 5/8 x 3/4 3/4 x 25/32 3/4 x 7/8 13/16 x 7/8 7/8 x 15/16 15/16 x 1 1 x 1.1/8
18		50-12 CPP	★		MM 8 9 10 11 12 13 14 15 16 17 18 19 21 22 23 24 26 27
16				☆	AF 3/8 7/16 1/2 9/16 19/32 5/8 11/16 3/4 25/32 13/16 7/8 15/16 1 1.1/16 1.1/8 1.1/4
1		50-00-7 CP	★	☆	270 mm
1		50-03 CPP	★	☆	300 mm
1		50-04 CPP	★	☆	125 mm
1		50-05 CPP	★	☆	250 mm



enthaltend / containing

★ = 933-M ☆ = 933-AF

Stck. pcs.	Artikel article	No.	M	AF	Maße sizes
1		50-06 CPP	★	☆	80 mm
9		100-12 C	★	☆	MM 30 32 33 36 38 41 46 50 55 AF 1.1/4 1.5/16 1.7/16 1.1/2 1.5/8 1.11/16 1.3/4 1.7/8 2
1		100-00-6 C	★	☆	490 mm
1		100-03-5 C	★	☆	59 mm
1		100-03-6 C	★	☆	470 mm
1		100-04 C	★	☆	200 mm
1		315 CP	★	☆	240 mm
1		50-19-3 CP	★	☆	MM 16 AF 5/8
1		1200 CPD	★	☆	180 mm
1		1208 CPD	★	☆	200 mm
1		1212 CPD	★	☆	160 mm
1		1231 N	★	☆	340 mm
1		1250 CPD	★	☆	175 mm
1		1255 CPD	★	☆	180 mm
1		1280 N	★	☆	250 mm
1		1327 C	★	☆	für/for ø bis/up to 240 mm 280 mm
9		1340 B	★	☆	MM 6 7 8 9 10 12 14 17 19 AF 1/4 9/32 5/16 3/8 7/16 1/2 9/16 5/8 3/4
3		1411 C	★	☆	PH No. 1 2 3
1		1419 MS	★	☆	6 – 24 V
1		1436 CI	★	☆	75 x 3 mm
3		1437 C	★	☆	100 x 5,5 150 x 8 200 x 12 mm
2		1500 C	★	☆	500 mm
2		1520 LS	★	☆	300 g 1000 g
2		1522 AS	☆	☆	3/4 lb. 2 lbs.
1		2165 ST	★	☆	ø 35 mm
2		1555 LS	★	☆	125 x 16 200 x 25 mm
3		1565 LS	★	☆	150 x 4 150 x 6 150 x 8 mm
1		1575 LS	★	☆	150 x 5 mm
1		1610 C/CL	★	☆	450 mm
1		1662 LS	★	☆	200 mm
1		1675 ST + 1681-5	★	☆	250 mm
1		1679 ST + 1681-3	★	☆	200 mm
1		1755 ST	★	☆	295 mm – 4 Reihen/rows
1		1782-2 ST	★	☆	250 ccm
1		1814-3 P/N 1814-12 P/N	★	☆	18 Blatt/blades 0,05 – 1,0 mm 13 Blatt/blades .002 – .035"
1		1920 ST	★	☆	10 m

942

Mechanik, Industrie und Wartung

Großes Mechanik-Sortiment

Mechanics, industry and maintenance

Comprehensive mechanics' set

Mécanique, industrie et entretien

Sélection complète pour mécanicien

Taller mecánico, industria y mantenimiento

Conjunto grande para taller mecánico



Code	No.	Stck. / pcs.			EAN
00942000282	942-M	140	20140	1	021134
00942000382	942-AF	135	20200	1	021141

Code	No.	Stck. pcs.	Behältnis receptacle			EAN
01128942282	1128-942-M	141		75150	1	142648
01128942382	1128-942-AF	136		75200	1	142631
			1128			

enthaltend / containing

★ = 942-M ☆ = 942-AF

Stck. pcs.	Artikel article	No.	M	AF	Maße sizes
12		350 CP	★	☆	MM 6 x 7 8 x 9 10 x 11 12 x 13 14 x 15 16 x 17 18 x 19 20 x 22 21 x 23 24 x 27 25 x 28 30 x 32 AF 1/4 x 5/16 3/8 x 7/16 1/2 x 9/16 19/32 x 11/16 5/8 x 11/16 5/8 x 3/4 3/4 x 25/32 13/16 x 7/8 7/8 x 15/16 15/16 x 1 1 x 1.1/8 1.1/16 x 1.1/4
12		475 CP	★	☆	MM 6 x 7 8 x 9 10 x 11 12 x 13 14 x 15 16 x 17 18 x 19 20 x 22 21 x 23 24 x 27 25 x 28 30 x 32 AF 1/4 x 5/16 3/8 x 7/16 1/2 x 9/16 5/8 x 11/16 5/8 x 3/4 3/4 x 25/32 3/4 x 7/8 13/16 x 7/8 7/8 x 15/16 15/16 x 1 1 x 1.1/8 1.1/16 x 1.1/4
1		390 CP	★	☆	205 mm
1		27-3010-M CPP			1/4" □ Steckschlüssel-Garnitur/ Socket set
(17)		27-4010-AF CPP			MM 4-13 1/4" □ Steckschlüssel-Garnitur/ Socket set
23		50-12 CPP	★		MM 8 9 10 11 12 13 14 15 16 17 18 19 20 21 22 23 24 26 27 28 29 30 32
18				☆	AF 3/8 7/16 1/2 9/16 19/32 5/8 11/16 3/4 25/32 13/16 7/8 15/16 31/32 1 1.1/16 1.1/8 1.3/16 1.1/4
1		50-00-7 CP	★	☆	270 mm
1		50-02 CPP	★	☆	405 mm
1		50-03 CPP	★	☆	300 mm
1		50-04 CPP	★	☆	125 mm
1		50-05 CPP	★	☆	250 mm
1		50-06 CPP	★	☆	80 mm
1		50-08 CPP	★	☆	375 mm
1		50-19-1 CP	★		MM 20,8
				☆	AF 13/16
1		300 CPI	★	☆	240 mm
1		1200 CPI	★	☆	180 mm
1		1206 CPI	★	☆	160 mm
1		1207 CPI	★	☆	160 mm
1		1212 CPI	★	☆	160 mm



enthaltend / containing

★ = 942-M ☆ = 942AF

Stck. pcs.	Artikel article	No.	M	AF	Maße sizes
1		1280 N	★	☆	250 mm
1		1250 CPD	★	☆	175 mm
1		1255 CPD	★	☆	180 mm
1 (8)		K 1340-8 B	★	☆	MM 2 2,5 3 4 5 6 8 10 AF 1/16 5/64 3/32 1/8 5/32 3/16 7/32 1/4
2		1411 C	★	☆	PH No. 1 2
2		1412 C	★	☆	PZ No. 1 2
3		1436 CI	★	☆	75 x 3 100 x 3 125 x 4 mm
4		1437 C	★	☆	100 x 5,5 125 x 6,5 150 x 8 200 x 12 mm
1 (5)		1491 ST	★	☆	M 3 – 18 1/8 – 3/4"
1		1494-2 CPP	★	☆	1800 g
1		1520 LS	★		300 g
1		1522 AS		☆	1/2 lb.
1		2165 ST	★	☆	∅ 32 mm
2		1555 LS	★	☆	150 x 18 200 x 25 mm
4		1565 LS	★	☆	150 x 2 150 x 4 150 x 6 150 x 8 mm
3		1570 LS	★	☆	120 x 4 120 x 6 120 x 8 mm
1		1575 LS	★	☆	120 x 4 mm
1		1610 C/CL	★	☆	450 mm
1		1656 Z	★	☆	145 mm
1		1668 ST	★	☆	90/200 mm
1		1670 ZCG	★	☆	M 5 – 27 5/16 – 1.1/2" UNF (NF)
1		1675 ST + 1681-5	★	☆	250 mm
1		1676 ST + 1681-5 ST	★	☆	250 mm
1		1677 ST + 1681-3 ST	★	☆	200 mm
1		1678 ST + 1681-3	★	☆	200 mm
1		1679 ST + 1681-3	★	☆	200 mm
2		1686-1 B	★	☆	150 mm
1		1754 ST	★	☆	260 mm
1		1755 ST	★	☆	290 mm – 3 Reihen/rows
1		1782-2 ST	★	☆	125 ccm
1		1806 C	★	☆	140 mm / 5.1/2"
1		1814-3 P/N 1814-12 P/N	★	☆	18 Blatt/blades 0,05 – 1,0 mm 13 Blatt/blades .002 – .035"
1		1836 ST	★	☆	300 mm / 12"
1		1839-2 ST	★	☆	3 m / 118"
1		1920 ST	★	☆	10 m
1		HEYNEN No.103	★	☆	400 mm

943

Mechanik, Industrie und Wartung

Industrie + Wartung

Mechanics, industry and maintenance

Industry and maintenance

Mécanique, industrie et entretien

Sélection pour industrie et entretien

Taller mecánico, industria y mantenimiento

Conjunto para industria y mantenimiento



Code	No.	Stck. pcs.			EAN
00943000282	943-M	165	30350	1	021158
00943000382	943-AF	156	33290	1	021165

Code	No.	Stck. pcs.	Behältnis receptacle			EAN
01128943282	1128-943-M	166		85827	1	346985
01128943382	1128-943-AF	157		88688	1	346992
			1128			

enthaltend / containing		★ = 943-M ☆ = 943-AF				
Stck. pcs.	Artikel article	No.	M	AF	Maße sizes	
7		350 CP	★	☆	MM 6 x 7 8 x 9 10 x 11 12 x 13 14 x 15 16 x 17 18 x 19 AF 1/4 x 5/16 3/8 x 7/16 1/2 x 9/16 5/8 x 11/16 3/4 x 25/32 13/16 x 7/8 15/16 x 1	
24		400 CP	★		MM 6 7 8 9 10 11 12 13 14 15 16 17 18 19 21 22 23 24 26 27 28 29 30 32	
20				☆	AF 1/4 5/16 3/8 7/16 1/2 9/16 5/8 11/16 3/4 13/16 7/8 15/16 1 1.1/16 1.1/8 1.1/4 1.5/16 1.3/8 1.1/2 1.5/8	
7		475 CP	★		MM 6 x 7 8 x 9 10 x 11 12 x 13 14 x 15 16 x 17 18 x 19 ☆ AF 1/4 x 5/16 3/8 x 7/16 1/2 x 9/16 5/8 x 11/16 3/4 x 25/32 13/16 x 7/8 15/16 x 1	
1		390 CP	★	☆	205 mm	
1		27-3010-M CPP			1/4" □ Steckschlüssel-Garnitur/ Socket set MM 4-13	
(17)		27-4010-AF CPP			1/4" □ Steckschlüssel-Garnitur/ Socket set AF 1/8-9/16	
23		50-12 CPP	★		MM 8 9 10 11 12 13 14 15 16 17 18 19 20 21 22 23 24 26 27 28 29 30 32	
18				☆	AF 3/8 7/16 1/2 9/16 19/32 5/8 11/16 3/4 25/32 13/16 7/8 15/16 31/32 1 1.1/16 1.1/8 1.3/16 1.1/4	
1		50-19-1 CP	★	☆	MM 20,8 AF 13/16	
1		50-00-7 CP	★	☆	270 mm	
1		50-02 CPP	★	☆	405 mm	
1		50-03 CPP	★	☆	300 mm	
1		50-04 CPP	★	☆	125 mm	
1		50-05 CPP	★	☆	250 mm	
1		50-06 CPP	★	☆	80 mm	
1		50-08 CPP	★	☆	375 mm	
11		100-12 C	★		MM 27 29 30 32 33 36 38 41 46 50 55 ☆ AF 1.1/16 1.1/8 1.1/4 1.5/16 1.7/16 1.1/2 1.5/8 1.11/16 1.3/4 1.7/8 2	
1		100-00-5 C	★	☆	165 mm	
1		100-03-5 C	★	☆	59 mm	



enthaltend / containing

★ = 943-M ☆ = 943-AF

Stck. pcs.	Artikel article	No.	M	AF	Maße sizes
1		100-03-6 C	★	☆	470 mm
1		100-04 C	★	☆	200 mm
1		100-05 C	★	☆	400 mm
1		100-06 C	★	☆	110 mm
1		300 CPI	★	☆	240 mm
1		1200 CPI	★	☆	180 mm
1		1206 CPI	★	☆	160 mm
1		1207 CPI	★	☆	160 mm
1		1212 CPI	★	☆	160 mm
1		1280 N	★	☆	250 mm
1 (8)		K 1340-8 B	★	☆	MM 2 2,5 3 4 5 6 8 10 AF 1/16 5/64 3/32 1/8 5/32 3/16 7/32 1/4
4		1411 C	★	☆	PH No. 1 2 3 4
2		1412 C	★	☆	PZ No. 1 2
2		1436 CI	★	☆	75 x 3 125 x 4 mm
3		1437 C	★	☆	100 x 5,5 150 x 8 200 x 12 mm
1 (5)		1491 ST	★	☆	M 3 – 18 1/8 – 3/4"
1		1494-2 CPP	★	☆	1800 g
2		1520 LS	★		300 g 800 g
2		1522 AS		☆	1/2 lb. 1.1/2 lbs.
1		2165 ST	★	☆	∅ 32 mm
1		1555 LS	★	☆	200 x 25 mm
1		1560 LS	★	☆	200 x 8 mm
4		1565 LS	★	☆	150 x 2 150 x 4 150 x 6 150 x 8 mm
1		1575 LS	★	☆	150 x 5 mm
1		1610 C/CL	★	☆	450 mm
1		1656 Z	★	☆	145 mm
1		1668 ST	★	☆	90/200 mm
1		1670 ZCG	★	☆	M 5 – 27 5/16 – 1.1/2" UNF (NF)
1		1675 ST + 1681-5	★	☆	250 mm
1		1676 ST + 1681-5 ST	★	☆	250 mm
1		1677 ST + 1681-3 ST	★	☆	200 mm
1		1679 ST + 1681-3	★	☆	200 mm
2		1686-1 B	★	☆	150 mm
1		1754 ST	★	☆	260 mm
1		1755 ST	★	☆	290 mm – 3 Reihen/rows
1		1782-2 ST	★	☆	250 ccm
1		1806 C	★	☆	140 mm / 5.1/2"
1		1814-3 P/N 1814-12 P/N	★	☆	18 Blatt/blades 0,05 – 1,0 mm 13 Blatt/blades .002 – .035"
1		1836 ST	★	☆	300 mm / 12"
1		1839-2 ST	★	☆	3 m / 118"
1		1842 B	★	☆	250 mm
1		1920 ST	★	☆	10 m

1000-914-M

Werkzeugsortiment im Werkzeugkasten

99-teilig
KFZ Werkstatt und Wartung

Mechanic' tool set

99 pcs.
Workshop and maintenance

Assortiment d'outils - boîte à outils

99 pièces
Atelier et entretien

Surtido de herramientas en caja

99 pzas
Talleres y mantenimiento de automoción

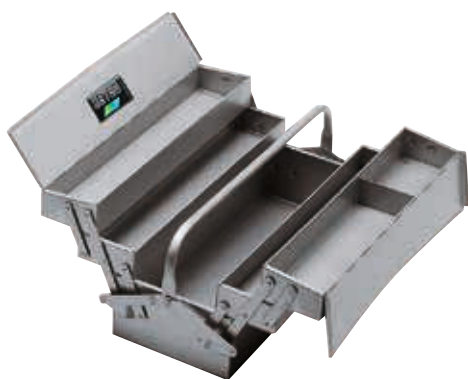

Code	No.	tlg. pcs.	Behältnis receptacle			EAN
01000091482	1000-914-M	99		14000	1	392777

enthaltend / containing

Stck. pcs.	Artikel article	No.	Maße sizes
12		350 CP	MM 6 x 7 8 x 9 10 x 11 12 x 13 14 x 15 16 x 17 18 x 19 20 x 22 21 x 23 24 x 26 25 x 28 27 x 32
12		475 CP	MM 6 x 7 8 x 9 10 x 11 12 x 13 14 x 15 16 x 17 18 x 19 20 x 22 21 x 23 24 x 26 25 x 28 27 x 32
1		390 CP	8" / 205 mm
1		1500 C	500 mm
1		1555 LS	200 x 25 mm
1		1560 LS	150 x 6 mm
1		1570 LS	120 / 2 mm
1		1575-4 LS	120 / 4 mm
1		1280 N	250 mm
1		50-19-1	20,8 mm
1		1445 C	25 x 4 mm
1		1430 C	150 x 8 mm 200 x 10 mm
3		1411 C	No. 01 / 1 / 2 "Phillips"
22		50-12 CPP	1/2" 10 11 12 13 14 15 16 17 18 19 20 21 22 23 24 25 26 27 28 29 30 32
1		50-02 CPP	1/2" 405 mm
1		50-08 CPP	1/2" 385 mm
1		50-03 CPP	1/2" 300 mm
1		50-00-10	1/2" 270 mm
1		50-04 CPP	1/2" 125 mm
1		50-05 CPP	1/2" 250 mm
1		50-06 CPP	1/2"
1		1213 CPT	160 mm
1		1200 CPT	180 mm
1		2165 ST	Ø 35 mm
1 (8)		K 1340-8 B	MM 2 2,5 3 4 5 6 8 10
1		1675 ST	200 mm
1		1679 ST	200 mm
1		1677 ST	200 mm
1		1686-1-8	150 mm
1		1755 ST	4 Reihen/rows
1		1520 LS	500 gr.
1		1814-2 P/N	13 Blatt/blades 0,05 – 1,0 mm
1		1840 ST	5 m
1		1782-2 ST	250 ccm
1		2199 ST	40 mm
1		1610 ST	verstellbar/adjustable
1		300 CP	240 mm

1000-915-M

Werkzeugsortiment im Werkzeugkasten

99-teilig
KFZ Werkstatt und Wartung

Mechanic' tool set

99 pcs.
Workshop and maintenance

Assortiment d'outils - boîte à outils

99 pièces
Atelier et entretien

Juego de herramientas en caja

99 pzas
Talleres y mantenimiento de automoción

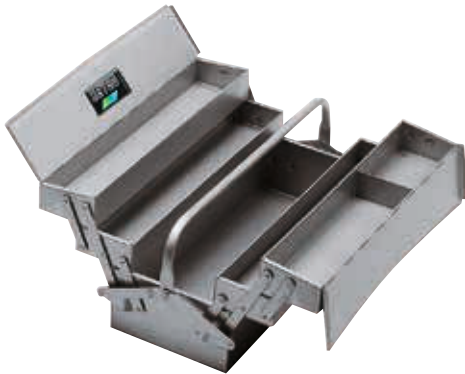

Code	No.	tlg. pcs.	Behältnis receptacle	g	1	EAN
01000091582	1000-915-M	99		14000	1	392791

enthaltend / containing

Stck. pcs.	Artikel article	No.	Maße sizes
24		400 CP	MM 6 7 8 9 10 11 12 13 14 15 16 17 18 19 20 21 22 23 24 25 26 27 28 32
1		390 CP	8" / 205 mm
1		1500 C	500 mm
1		1555 LS	200 x 25 mm
1		1560 LS	150 x 6 mm
1		1570 LS	120 / 2 mm
1		1575-4 LS	120 / 4 mm
1		1280 N	250 mm
1		50-19-1	20,8 mm
1		1445 C	25 x 4 mm
1		1430 C	150 x 8 mm 200 x 10 mm
3		1411 C	No. 01 / 1 / 2 "Phillips"
22		50-12 CPP	1/2" 10 11 12 13 14 15 16 17 18 19 20 21 22 23 24 25 26 27 28 29 30 32
1		50-02 CPP	1/2" 405 mm
1		50-08 CPP	1/2" 385 mm
1		50-03 CPP	1/2" 300 mm
1		50-00-10	1/2" 270 mm
1		50-04 CPP	1/2" 125 mm
1		50-05 CPP	1/2" 250 mm
1		50-06 CPP	1/2"
1		1213 CPT	160 mm
1		1200 CPT	180 mm
1		2165 ST	Ø 35 mm
1 (8)		K 1340-8 B	MM 2 2,5 3 4 5 6 8 10
1		1675 ST	200 mm
1		1679 ST	200 mm
1		1677 ST	200 mm
1		1686-1-8	150 mm
1		1755 ST	4 Reihen/rows
1		1520 LS	500 gr.
1		1814-2 P/N	13 Blatt/blades 0,05 – 1,0 mm
1		1840 ST	5 m
1		1782-2 ST	250 ccm
1		2199 ST	40 mm
1		1610 ST	verstellbar/adjustable
1		300 CP	240 mm

1000 1002

Werkzeugkästen

L = lackiert, aus Stahlblech, mit Vorhängeschloß verschließbar

Tool boxes

L = lacquered, sheet steel, lockable with padlock

Boîtes d'outillage, vides

L = laquées, en tôle d'acier, cadenassable

Cajas de herramientas

L = barnizado, de chapa de acero, cierre por candado

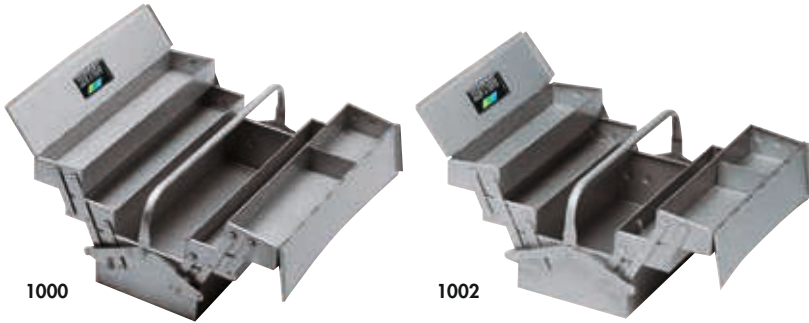

1000

1002

Code	No.	Maße dimensions	g	Fächer trays		EAN
01000010020	1000	530 x 200 x 200 mm	6500	5	1	021240
01002010020	1002	420 x 200 x 200 mm	5440	5	1	021332

* bitte gesondert bestellen: Vorhängeschloß HEYCO 2199

* please order separately: Padlocks HEYCO 2199

* a commander séparément: Cadenas HEYCO 2199

* los rogamos lo pidan por separado: Candado HEYCO 2199

1101

Werkzeugschrank

L = lackiert

Wall cabinet

L = lacquered

Armoires murales d'outillage, vides

L = laquées

Armarios de herramientas

L = barnizado



Code	Maße dimensions	g		EAN
01101010020	650 x 200 x 780 mm	21000	1	021769

Mit 1 Schublade und Halterungen für Werkzeuge sowie Schale für Steckschlüssel-Garnitur, 2-flügelige Tür mit Treibstangen, Knopfgriff und Sicherheitschloß aus Stahlblech.

With 1 drawer and mountings for tools as well as tray for socket set, 2-winged door with locking bars, knob handle and security lock, sheet steel.

Avec 1 tiroir et fixations pour outils ainsi qu'un plateau pour composition de douilles, porte à 2 battants avec serrure à clé et blocage instantané par crémonne, à accrochage central, en tôle d'acier.

Con un cajón y ganchos de sujeción para herramientas, así como una bandeja, para colocar un juego de llaves de vaso, puerta de 2 hojas con cierre por varilla, y manilla de seguridad, de chapa de acero.

1135

Werkzeugtruhe

L = lackiert, mit 4 Schubladen, Arbeitsplatte aus Kunststoff, Zentralverschluss durch Zylinderschloß, 2 ausklappbare Haltegriffe

Tool chest

L = lacquered, with 4 drawers, Plastic working top, locking mechanism through cylinder lock, 2 handles on side face

Coffres d'outillage, vides

L = laquées, avec 4 tiroirs, Plan de travail en plastique, verrouillage central par serrure à cylindre, 2 poignées latérale

Cofres de herramientas

L = barnizado, con 4 bandejas, placa de trabajo de plástico, cierre central mediante cerradura cilíndrica, 2 mangos abatibles laterales



Code	Maße dimensions	g		EAN
01135010020	600 x 440 x 450 mm	31000	1	022308



geeignet als Aufsatz für Werkstattwagen HEYCO No. 1129 (Seite 124)

suitable as attachment for workshop trolley HEYCO NO 1129 (page 124)

peuvent être utilisées comme fixation pour servante d'atelier HEYCO N°1129 (page 124)

adecuado como suplemento al carro de herramientas HEYCO nr. 1129 (página 124)



WERKSTATTWAGEN,
LEER UND BESTÜCKT
WORKSHOP TROLLEY,
EMPTY AND ASSEMBLED



INTELLIGENT TOOLS

START-STOPP-AUTOMATIK
START-STOPP-AUTOMATIC



YOU
TUBE





DIE SYNTHESE AUS RAUM, SICHERHEIT UND ERGONOMIE.

Der weltweit erste Werkstattwagen mit automatischem Softeinzug und Sicherheits-Zwei-Rad-Bremssystem mit Start/Stop Automatik.

Abmessungen: ca. 1170 x 1020 x 660 mm aus Stahlblech, Korpus schwarz - Schubladen schwarz, Ablagefläche aus Holz. Maße: ca. 900 x 520 x 30 mm, getrennte Verriegelungen der Front- und Seitenschubfächer durch zwei Zylinderschlösser

11 Schubladen + 1 Ablagefach

- 1 6 Schubladen ca. 565 x 415 x 50 mm
- 2 1 Schublade ca. 565 x 415 x 110 mm
- 3 1 Schublade ca. 565 x 415 x 170 mm
- 4 1 Schublade ca. 440 x 125 x 250 mm
- 5 1 Schublade ca. 440 x 125 x 450 mm
- 6 1 Schublade ca. 540 x 360 x 50 mm
- 7 1 Ablagefach ca. 700 x 390 x 65 mm

2 Lenkrollen, 2 Festrollen, Tragfähigkeit bis 600 kg, ca. 30 kg Belastbarkeit pro Schubfach, Leergewicht ca. 110 kg

THE SYNTHESIS OF SPACE, SECURITY AND ERGONOMICS.

The world-wide first workshop trolley with automatic drawers soft close and security-2-wheels braking system with automatic start/stop mechanism.

Dimensions: approx. 1170 x 1020 x 660 mm from sheet steel, body black - drawers black. Working top of wood. Dimensions: approx. 900 x 520 x 30 mm, separate locking mechanism for front- and side drawers with two cylinder locks

11 drawers + 1 storage compartment

- 1 6 drawers approx. 565 x 415 x 50 mm
- 2 1 drawer approx. 565 x 415 x 110 mm
- 3 1 drawer approx. 565 x 415 x 170 mm
- 4 1 drawer approx. 440 x 125 x 250 mm
- 5 1 drawer approx. 440 x 125 x 450 mm
- 6 1 drawer approx. 540 x 360 x 50 mm
- 7 1 additional compartment approx. 700 x 390 x 65 mm

2 steering rollers, 2 castors, total carrying capacity up to 600 kg, approx. 30 kg loading capacity for each drawer, weight empty approx. 110 kg

LA SYNTHÈSE DE L'ESPACE, DE SÉCURITÉ ET D'ERGONOMIE.

Première servante d'atelier avec fermeture automatique et système de freinage sécurité à deux roues et démarrage/arrêt automatique.

Dimensions: environ 1170 x 1020 x 660 mm en tôle d'acier, corps noir - tiroirs noir. Tablette en bois. Taille: environ 900 x 520 x 30 mm, verrous séparés sur les tiroirs frontaux et latéraux par deux serrures cylindriques

11 tiroirs + 1 compartiment de rangement

- 1 6 tiroirs env. 565 x 415 x 50 mm
- 2 1 tiroir env. 565 x 415 x 110 mm
- 3 1 tiroir env. 565 x 415 x 170 mm
- 4 1 tiroir env. 440 x 125 x 250 mm
- 5 1 tiroir env. 440 x 125 x 450 mm
- 6 1 tiroir env. 540 x 360 x 50 mm
- 7 1 tablette env. 700 x 390 x 65 mm

2 roues pivotantes, 2 fixes, capacité de charge de 600 kg maxi, capacité de charge par tiroir est de 30 kg, poids vide env. 110 kg

LA SÍNTESIS DE ESPACIO, SEGURIDAD Y ERGONOMÍA.

El primer carro de taller a nivel mundial con cierre amortiguado de los cajones y sistema de frenos de seguridad en 2 ruedas con automatismo Start/Stop.

Medidas aprox. 1170 x 1020 x 660 mm de chapa de acero, cuerpo y cajones de color negro. Tabla de trabajo de madera, medidas aprox. 900 x 520 x 30 mm, cerraduras separadas para los cajones frontales y laterales

11 cajones + 1 compartimento de almacenamiento

- 1 6 cajones de aprox. 565 x 415 x 50 mm
- 2 1 cajón de aprox. 565 x 415 x 110 mm
- 3 1 cajón de aprox. 565 x 415 x 170 mm
- 4 1 cajón de aprox. 440 x 125 x 250 mm
- 5 1 cajón de aprox. 440 x 125 x 450 mm
- 6 1 cajón de aprox. 540 x 360 x 50 mm
- 7 1 bandeja de aprox. 700 x 390 x 65 mm

2 ruedas giratorias, 2 ruedas fijas, 600 kg de carga total máxima, carga admisible por cajón aprox. 30 kg, peso en vacío aprox. 110 kg

A+B	Kugelgelagerte Teleskopschienen voll ausziehbar und belastbar mit gedämpftem Softeinzug.
C	Optimale Raumaussnutzung durch senkrecht angeordnete Schubladen für Verbrauchsmaterial und Werkzeuge. Ideal für Dosen und Flaschen.
D	Alufelgen mit Niederquerschnittsreifen und Sicherheits-Zwei-Rad-Bremssystem. Die automatische Betätigung garantiert einen sicheren Stand auch bei unebenen Bodenverhältnissen.
E	Griffleiste aus hochwertigem Luffhraluminium.
F+G	Stabiler Griff mit integrierter Start/Stop Automatik zum einfachen Lösen der Feststellbremse. Beim Loslassen des Griffes wird die Feststellbremse automatisch betätigt.
H	Zwei separat abschließbare Staufächer, zur sicheren Aufbewahrung von hochwertigen Meß- und Prüfgeräten.

A+B	Telescopic slides with ball bearings fully extendable, with high load capacity and damped soft close mechanism.
C	Optimal utilization of space by vertically arranged drawers for consumables and tools. Ideal for cans and bottles.
D	Alloy wheels with low profile tyres and safety 2-wheels braking system. The automatic operation ensure a safe stand, also on uneven ground conditions.
E	Handle made of aeronautical aluminium.
F+G	Stable handle with integrated Start/Stop automatic for easy release of the brake. When releasing the handle the brake is automatically actuated.
H	Two separately lockable storage compartments, for safe storage of high value testing equipment.

A+B	Glissières à boule télescopiques robustes avec soft close amortie.
C	Utilisation optimale de espace à l'aide de tiroirs verticaux pour la fourniture des outils. Idéal pour canettes et bouteilles.
D	Jantes en alliage avec pneus à profil bas, système de freinage sur deux roues. Le fonctionnement automatique assure une position stable même sur un sol inégal.
E	Poignée en aluminium de qualité aéronautique.
F+G	Poignée robuste intégrant marche/arrêt automatique pour un démouillage facile du frein de stationnement. Après avoir relâché le frein de stationnement est automatiquement activé.
H	Deux compartiments de rangement séparées fermant à clé pour stockage sûr des mesures de haute.

A+B	Guías telescópicas con rodamientos de bolas, de extracción total, resistentes con cierre amortiguado.
C	Aprovechamiento óptimo gracias a cajones verticales para material auxiliar y herramientas. Idóneo para botes y botellas.
D	Llantas de aluminio con neumáticos de bajo perfil y sistema de frenos de seguridad a dos ruedas. El accionamiento automático garantiza un apoyo firme incluso en suelos desiguales
E	Listón de aluminio aeronáutico.
F+G	Asa robusta con automatismo Start/Stop integrado para soltar el freno. Al soltar el asa, el freno se acciona automáticamente.
H	2 cajones con cerradura para almacenar instrumentos de valor.

Abbildung kann von der Serie abweichen - Serienänderungen vorbehalten!



Illustration can differ from series, which is subject to change without prior notice!



Photos peuvent varier — sous réserve de changement de série!



La foto puede diferir del producto en serie. Nos reservamos el derecho de modificar el producto en serie!



1127-1

Werkstattswagen „INTELLIGENT TOOLS“, leer

- Automatisches Bremssystem
- Automatischer Softeinzug der Schubladen
- Hochwertige Arbeitsplatte aus Holz

Workshop trolley „INTELLIGENT TOOLS“, empty

- Automatic braking system
- Automatic drawers soft close
- High-quality wooden worktop



Servante d'atelier „INTELLIGENT TOOLS“, vides

- Autofreinage
- Fermeture automatique des tiroirs
- Plan de travail en bois de qualité

Carros de taller „INTELLIGENT TOOLS“, vacío

- Sistema de frenado automático
- Cierre automático amortiguado de los cajones
- Tabla de trabajo de madera de alta calidad



Code	Maße dimensions	 g		EAN
01127010020	1170 x 660 x 1020 mm	110000	1	373004



START-STOPP-AUTOMATIK
START-STOPP-AUTOMATIC



YOU
TUBE

1127-2

Werkstattswagen „PROFESSIONAL“, leer

- 2 Lenkrollen mit Feststellbremse
- Automatischer Softeinzug der Schubladen
- Hochwertige Arbeitsplatte aus Holz

Workshop trolley „PROFESSIONAL“, empty

- 2 steering rollers with parking brake
- Automatic drawers soft close
- High-quality wooden worktop



Servante d'atelier „PROFESSIONAL“, vides

- 2 roues pivotantes à frein
- Fermeture automatique des tiroirs
- Plan de travail en bois de qualité

Carros de taller „PROFESSIONAL“, vacío

- 2 ruedas giratorias con freno
- Cierre automático amortiguado de los cajones
- Tabla de trabajo de madera de alta calidad



Code	Maße dimensions	 g		EAN
01127020020	1170 x 660 x 1020 mm	105000	1	375893



1127-3

Werkstattwagen „BASIC“, leer

- 2 Lenkrollen mit Feststellbremse
- Mit ABS-Arbeitsplatte

Workshop trolley „BASIC“, empty



- 2 steering rollers with parking brake
- With ABS worktop

Servante d'atelier „BASIC“, vides

- 2 roues pivotantes à frein
- Avec plan de travail ABS

Carros de taller „BASIC“, vacío

- 2 ruedas giratorias con freno
- Tabla de trabajo de plástico ABS

Code	Maße dimensions	 g		EAN
01127030020	1170 x 660 x 1020 mm	98000	1	375886



1128

Werkstattwagen, leer

- 2 Lenkrollen mit 2 Feststellbremsen
- Mit ABS-Arbeitsplatte

Workshop trolley, empty

- 2 steering rollers with 2 castors
- With ABS worktop

Servantes d'outillage, vides

- 2 roues pivotantes avec 2 freins de stationnement
- Plan de travail en ABS

Carros de taller, vacío

- 2 ruedas articuladas con 2 frenos
- Con placa de ABS

Code	Maße dimensions	 g		EAN
01128010020	885 x 511 x 850 mm	57000	1	129373

HEYCO

formel plus



FORMEL plus

WERKSTATTWAGEN

Abmessungen: ca. 885 x 511 x 850 mm aus Stahlblech.
Ablagefläche Maße: ca. 670 x 470 mm.
Korpus grau - Schubladen schwarz. Verriegelung durch
Zylinderschloss mit ABS-Arbeitsplatte.

- 7 Schubladen
- ① 3 Schubladen ca. 565 x 415 x 55 mm
- ② 2 Schubladen ca. 565 x 415 x 72 mm
- ③ 1 Schublade ca. 565 x 415 x 175 mm
- ④ 1 Schublade ca. 310 x 435 x 75 mm

2 Lenkrollen, 2 Feststellrollen, ca. 30 kg Belastbarkeit
pro Schubfach, Leergewicht ca. 57 kg.
Tragfähigkeit bis 400 kg.

SERVANTE D'OUTILLAGE

Dimensions: environ 885 x 511 x 850 mm en tôle d'acier.
Tablette taille: environ 670 x 470 mm.
Corps gris - tiroirs noir-verouillage par serrure à cylindre -
plan de travail en ABS.

- 7 tiroirs
- ① 3 tiroirs env. 565 x 415 x 55 mm
- ② 2 tiroirs env. 565 x 415 x 72 mm
- ③ 1 tiroir env. 565 x 415 x 175 mm
- ④ 1 tiroir env. 310 x 435 x 75 mm

2 rouleaux de guidage, 2 roulettes, approx. 30 kg capacité
de charge pour chaque tiroir, poids vide approx. 57 kg.
Capacité de charge jusqu'à 400 kg

WORKSHOP TROLLEY

Dimensions: approx. 885 x 511 x 850 mm from
sheet steel. Working top dimensions: approx.
670 x 470 mm. Body grey - drawers black.
Locking by cylinder lock with ABS work top.

- 7 drawers
- ① 3 drawers approx. 565 x 415 x 55 mm
- ② 2 drawers approx. 565 x 415 x 72 mm
- ③ 1 drawer approx. 565 x 415 x 175 mm
- ④ 1 drawer approx. 310 x 435 x 75 mm

2 steering rollers, 2 castors, approx. 30 kg loading
capacity for each drawer, weight empty approx. 57 kg.
Load capacity up to 400 kg

CARRO DE HERRAMIENTAS

Dimensiones: aprox. 885 x 511 x 850 mm
de chapa de acero. Tabla medidas aprox.
670 x 470 mm. Cuerpo de color gris,
cajones de color negro, con cierre.

- 7 cajones
- ① 3 cajones de aprox. 565 x 415 x 55 mm
- ② 2 cajones de aprox. 565 x 415 x 72 mm
- ③ 1 cajón de aprox. 565 x 415 x 175 mm
- ④ 1 cajón de aprox. 310 x 435 x 75 mm

2 ruedas giratorias, 2 ruedas fijas, carga admisible por cajón
aprox. 30 kg, peso en vacío aprox. 57 kg.
Capacidad de carga hasta 400 kg





1129

Werkstattswagen „ECONOMY“, leer
aus Stahlblech, lackiert

Workshop trolley „ECONOMY“, empty
from sheet steel, lacquered

Servantes d'outillage „ECONOMY“, vides
acier, laquées

Carros de taller „ECONOMY“, vacío
con freno, barnizado



Code	Maße dimensions			EAN
01129010020*	750 x 550 x 950 mm	58000	1	326611

7 Schubladen mit Kugelführungen, die 2 unteren Schubladen mit großem Staufach, mit 4 Rollen, davon 2 Lenkrollen, feststellbar,
7 drawers with ball bearings, the 2 lower drawers with large storage compartment, 2 steering roller with brake and 2 castors,
7 tiroirs sur glissières à billes, les 2 tiroirs basses à grand compartiment de rangement, avec 4 roues dont 2 pivotantes, verrouillables,
7 cajones de chapa de acero, con guías sobre rodamientos de bolas, los 2 inferiores con amplia bandeja, con 4 ruedas, de las cuales 2 giratorias,

7 Schubladen/drawers/tiroirs/cajones
1-5: 440 x 350 x 60 mm
6-7: 440 x 350 x 140 mm

Ablagefläche Maße/working top dimensions/tablette taille/tabla medidas
600 x 430 mm

Belastbarkeit/loading capacity/capacité de charge/carga admisible por cajón
ca. 30 kg Belastbarkeit pro Schubfach/approx. 30 kg loading capacity for each drawer/approx. 30 kg capacité de charge pour chaque tiroir/carga admisible por cajón aprox. 30 kg

Tragfähigkeit/load capacity/capacité de charge/capacidad de carga
400 kg

1128/1129-8-15

Schutzhülle
für Werkstattswagen HEYCO 1128/1129

Protection cover
for workshop trolley HEYCO 1128/1129

Couvrir
pour servantes d'outillage HEYCO 1128/1129

Funda protectora
para carros de taller HEYCO 1128/1129



Code	Maße dimensions	für/for HEYCO No.		EAN
01128801500	940 x 500 x 730 mm	1128	1	342017
01129801500	730 x 500 x 840 mm	1129	1	342000

1128-8-9

Zubehör
1 Gummimatte für HEYCO 1128

Accessories
Rubber mat for HEYCO 1128

Accessoires
Tapis en caoutchouc pour HEYCO 1128

Accesorios
Alfombra de goma para HEYCO 1128

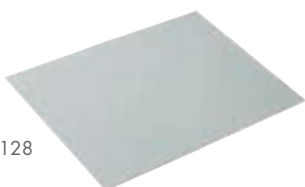

Code	Maße dimensions	für/for HEYCO No.		EAN
01128110100	562 x 416 x 2 mm	1128	1	172034

1128-8-5

Zubehör
Trennleisten für HEYCO 1128

Accessories
Divider set for HEYCO 1128

Accessoires
Sectionneurs pour HEYCO 1128

Accesorios
Listones separadores para HEYCO 1128

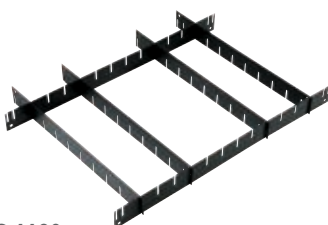

Code	Maße dimensions	für/for HEYCO No.		EAN
01128110200	560 x 410 x 45 mm	1128	1	172041

1129-8-1 - 1129-8-12

Zubehör für HEYCO No. 1129

Accessories for HEYCO No. 1129

Accessoires pour HEYCO No. 1129

Accesorios para HEYCO No. 1129

1129-8-1

Papierkorb

Waste-paper basket

Corbeille

Papelera



Code	No.	Maße dimensions		EAN
91129800120*	1129-8-1	300 x 250 x 300 mm	1	328943

1129-8-2

Papierrollenhalter

Paper roll holder

Porte-rouleau

Sujeción para rollo de papel



Code	No.	Maße dimensions		EAN
91129800220*	1129-8-2	300 x 200 x 250 mm	1	328936

1129-8-3 (1129-8-4)

Trennblech/Satz

Divider set for drawers

Baffle/set

Juego de chapas separadoras



Code	No.	Maße dimensions		EAN
91129800360*	1129-8-3	348 x 60 mm	1	327274
91129800460*	1129-8-4	348 x 100 mm	1	328912

1129-8-5

Fachteiler/Satz

Slotted divider set for drawers

Diviseurs/set

Juego de divisiones



Code	No.	Maße dimensions		EAN
91129800560*	1129-8-5	348 x 100 x 60 mm	1	328882

1129-8-6

Ablageschale

Storage box

plateau

Bandeja



Code	No.	Maße dimensions		EAN
91129800620*	1129-8-6	220 x 60 x 80 mm	1	328929

1129-8-8

Dosenhalter

Tin holder

Porte canette

Sujeción para botes



Code	No.	Maße dimensions		EAN
91129800820*	1129-8-8	160 x 300 x 10 mm	1	328905



HEYCO

VARIABLE BESTÜCKUNG

VARIABLE ASSEMBLY

1127-1/-2/-3 + 1128

Variable Bestückung der großen Schubfächer im Werkstattwagen mit Modulen

Variable assembly alternatives of large drawers of workshop trolley

Exemples d'assortiment des grands tiroirs de la servante d'atelier

Dotación variable de los cajones grandes en carro de taller ref.



1127-1

1127-2

1127-3

1128

Beispiele/Examples/Exemple/Ejemplos

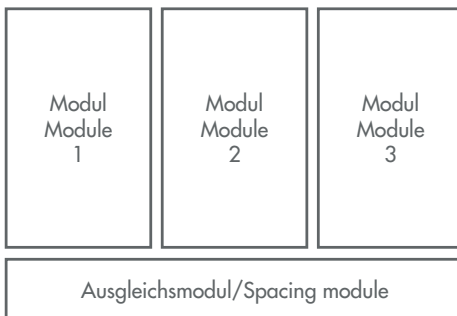

1129

Variable Bestückung der Schubfächer im Werkstattwagen mit Modulen

Variable assembly alternatives of drawers of workshop trolley

Exemples d'assortiment des tiroirs de la servante d'atelier

Dotación variable de los cajones en carro de taller ref.



1129

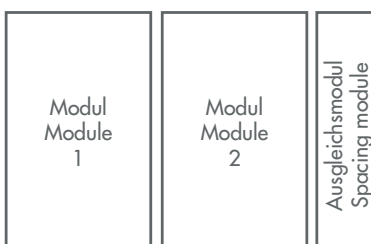

Beispiel/Example/Exemple/Ejemplos

E-970-5-ST

Ausgleichsmodul

Zum Auffüllen der Schubladen, geeignet zum Lagern von Kleinteilen
1127-1/-2/-3 + 1128

Spacing module

For filling the drawers, suitable for storing small parts
1127-1/-2/-3 + 1128

Module d'espacement

Pour remplir les tiroirs, adapté au stockage de petites pièces
1127-1/-2/-3 + 1128

Módulo de espaciado

Para llenar los cajones, adecuado para almacenar piezas pequeñas
1127-1/-2/-3 + 1128



Code	Maße dimensions	für/for HEYCO No.		EAN
00970000500	563 x 68 x 40 mm	1127-1/-2/-3 1128	1	425406

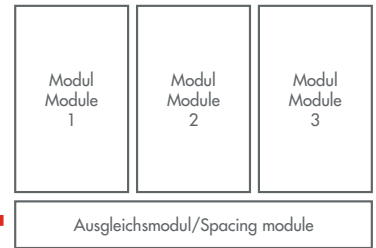

E-970-4-ST

Ausgleichsmodul

Zum Auffüllen der Schubladen, geeignet zum Lagern von Kleinteilen
1129

Spacing module

For filling the drawers, suitable for storing small parts
1129

Module d'espacement

Pour remplir les tiroirs, adapté au stockage de petites pièces
1129

Módulo de espaciado

Para llenar los cajones, adecuado para almacenar piezas pequeñas
1129



Code	Maße dimensions	für/for HEYCO No.		EAN
00970000400	341 x 65 x 40 mm	1129	1	425390

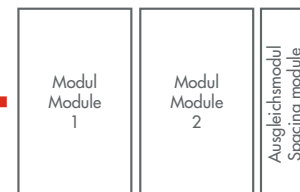

1127-3-3

Werkzeugsortiment in Werkstattwagen „BASIC“

Tool assortment in workshop trolley „BASIC“

Composition d'outillage en servantes d'atelier „BASIC“

Surtidos de herramientas para carro de taller „BASIC“



Code	tlg. pcs.	Module modules			EAN
01127000300	189	3	122820	1	382631

enthaltend /containing				
Stck. pcs.	Modul No. module No.	1128-21	1128-22	1128-23
3				
1				
	Art. No.	1127-3		



1128-21



1128-22



1128-23

1128-3

Werkzeugsortiment in Werkstattwagen 1128

Tool assortment in workshop trolley 1128

Composition d'outillage en servantes d'atelier 1128

Surtidos de herramientas para carro de taller 1128

HEYCO
FORMEL plus



Code	tlg. pcs.	Module modules			EAN
01128000300	189	3	76000	1	357851
enthaltend /containing					
Stk. pcs.	Modul No. module No.				
3		1128-21	1128-22	1128-23	
1		Art. No. 1128			



1128-21



1128-22



1128-23

1128-1-8

Werkzeugsortiment in Werkstattwagen 1128

Tool assortment in workshop trolley 1128

Composition d'outillage en servantes d'atelier 1128

Surtidos de herramientas para carro de taller 1128

HEYCO
FORMEL plus



Code	tlg. pcs.	Module modules			EAN
01128001800	59	8	74000	1	425925
enthaltend /containing					
Stk. pcs.	Modul No. module No.				
6		971-17 990-4	977-6 991-7	978-6-17 995-8	
2		Modul No. module No. E-970-5-ST			
1		Art. No. 1128			



971-17



977-6



978-6-17



990-4



991-7



995-8

E-970-5-ST 2 Stk./2 pcs.

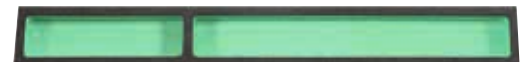
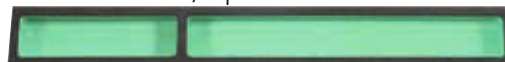

WERKZEUGSORTIMENTE IN 2-K SCHAUMEINLAGEN

TOOL ASSORTMENTS IN 2-K FOAM INLAYS



1128-21

Modul 1
bestehend aus 54 Werkzeugen

Module 1
containing 54 tools

Module 1
comprenant 54 outils

Módulo 1
compuesto de 54 herramientas



Code	Maße dimensions			EAN
01128812100	565 x 415 x 50 mm	5490	1	357868

17-tlg. Ringmaulschlüsselsatz / 17 pcs. combination wrench set
 6 · 7 · 8 · 9 · 10 · 11 · 12 · 13 · 14 · 15 · 16 · 17 · 18 · 19 · 21 · 22 · 24
 8-tlg. Doppelmäulschlüsselsatz / 8 pcs. double ended open jaw wrench set
 6 x 7 · 8 x 9 · 10 x 11 · 12 x 13 · 14 x 15 · 16 x 17 · 18 x 19 · 20 x 22
 verstellbarer Einmaulschlüssel / Adjustable wrench 310 mm
 9-tlg. Winkelschraubendrehersatz mit Kugelkopf / 9 pcs. ball head hexagonal wrench set
 1,5 · 2 · 2,5 · 3 · 4 · 5 · 6 · 8 · 10
 8-tlg. Winkelschraubendrehersatz / 8 pcs. ball head TORX®-wrench set
 TORX® T9 · T10 · T15 · T20 · T25 · T27 · T30 · T40
 Präzisions-Schieblehre / Precision vernier calipers
 13 tlg. Fühlerlehre / 13 pcs. feeler gauge 0,05 -1,0 mm
 Profi-Bandmass, Zink-Guss, Länge 5 m, mit Gürtelclip / Measuring tape, 5 m
 Cutter-Messer, 18 mm Klingenbreite, mit 5 Klingen / Utility knife, 18 mm
 Sicherheits-Rettungsmesser / Rescue knife
 LED-Teleskop-Taschenlampe / LED Torch light
 VDE-Flachrundzange, gerade, 160 mm / VDE Snip nose plier, straight, 160 mm
 VDE-Abisolierzange 160 mm / VDE Wire stripping plier, 160 mm
 VDE Spannungsprüfer 60 x 3 mm / VDE Voltage tester 60 x 3 mm
 VDE-Kreuzschlitz-Schraubendreher Gr. 1 / VDE Cross slot screwdriver, PH 1
 VDE-Elektriker-Schraubendreher 100 x 3,5 mm / VDE Electricians screwdriver 100 x 3,5 mm

1128-22

Modul 2
bestehend aus 110 Werkzeugen

Module 2
containing 110 tools

Module 2
comprenant 110 outils

Módulo 2
compuesto de 110 herramientas



Code	Maße dimensions			EAN
01128812200	565 x 415 x 50 mm	8530	1	357875

Hebel-Umschaltknarre / Reversible ratchet
 Verlängerungen 50, 105 mm / Extension bar 50, 105 mm
 Kardangelen, Steckgriff / Universal joint, spinner handle
 Steckschlüssel-Einsätze / Sockets 4 · 5 · 6 · 7 · 8 · 9 · 10 · 11 · 12 · 13
 Steckschlüssel-Einsätze TORX® / Sockets for TORX® head screws E4 · E5 · E6 · E7 · E8 · E10
 Schraubendreher-Einsätze Schlitz / Screwdriver sockets for plain slot screws
 0,8 x 4 · 1,0 x 5,5 · 1,2 x 8 mm
 Schraubendreher-Einsätze 6-kt. / Screwdriver sockets for hexagon socket screws
 3 · 4 · 5 · 6 · 8 mm
 Schraubendreher-Einsätze Kreuzschlitz / Screwdriver sockets for cross slot screws
 PH 1, PH 2, PZ 1, PZ 2
 Schraubendreher-Einsätze TORX® / Screwdriver sockets for TORX® socket screws
 T6 · T7 · T8 · T9 · T10 · T15 · T20 · T25 · T27 · T30 · T40
 Adapter für 1/4" Bits / Adapter for bits 1/4"
 Hebel-Umschaltknarre / Reversible ratchet
 Verlängerungen / Extension bar 75, 125, 250 mm
 Verlängerung, schwenkbar / Wobble extension 50 mm
 Kardangelen, Griff mit Gleitsstück / Universal joint, sliding T-Handle
 Zündkerzen-Einsätze / Spark plug socket 20,8 mm, 5/8"
 Steckschlüssel-Einsätze / Sockets hexagon 13 · 14 · 15 · 16 · 17 · 19 · 21 · 22 · 24 · 27 · 30 · 32
 Steckschlüssel-Einsätze TORX® / Sockets for TORX® head screws
 E11 · E12 · E14 · E16 · E18 · E20 · E24
 Schraubendreher-Einsätze Schlitz / Screwdriver sockets for plain slot screws
 10 x 1,6 · 12 x 2,0
 Schraubendreher-Einsätze 6-kt., Länge / Screwdriver sockets for hexagon socket screws,
 lg 52 mm, 7 · 10 · 12 · 14 · 17 mm
 Schraubendreher-Einsätze 6-kt., Länge / Screwdriver sockets for hexagon socket screws,
 lg 100 mm / 8 mm, Länge 140 mm / 10 mm
 Schraubendreher-Einsätze Kreuzschlitz / Screwdriver sockets for cross slot screws
 PH 3, PZ 3, PZ 4
 Schraubendreher-Einsätze TORX®, Länge / Screwdriver sockets for TORX® socket screws,
 lg 55 mm, T45 · T50 · T55 · T60
 Schraubendreher-Einsätze TORX®, Länge / Screwdriver sockets for TORX® socket screws,
 lg 120 mm, T40 · T45
 Schraubendreher-Einsätze XZN, Länge / Screwdriver sockets for multi-splin socket screws XZN,
 lg 52 mm, M5 · M6 · M8 · M10
 Schraubendreher-Einsätze XZN, Länge / Screwdriver sockets for multi-splin socket screws XZN,
 lg 100 mm / M8, Länge/lg 120 mm / M10
 Schraubendreher Schlitz / Screwdriver sockets eng. screwdriver for plain slot screws
 100 x 5,5 · 125 x 6,5 · 150 x 8 mm
 Schraubendreher Kreuzschlitz / Screwdriver sockets cross slot screwdriver
 PH 02 x 25 · PH 0 x 60 · PH 1 x 75 · PH 2 x 100 · PH 3 x 150
 Schraubendreher Kreuzschlitz / Screwdriver sockets cross slot screwdriver PZ 1 x 75 · PZ 2 x 100
 Elektriker-Schraubendreher / Electricians screwdriver 75 x 3 · 125 x 4 mm
 Vergaser-Schraubendreher / Stubby screwdriver 25 x 4 mm

1128-23

Modul 3

bestehend aus 25 Werkzeugen

Module 3

containing 25 tools

Module 3

comprenant 25 outils

Módulo 3

compuesto de 25 herramientas



Code	Maße dimensions			EAN
01128812300	565 x 415 x 50 mm	4791	1	357882

Kombinationszange / Combination plier 180 mm
Seitenschneider / Diagonal side nipper 160 mm
Flachrundzange, gerade / Snipe nose plier, straight 200 mm
Rohr- und Wasserpumpenzange / Multigrip plier 240 mm
Montagezange, aussen, gebogen / Circlip plier, ext, bent 165 mm
Montagezange, innen, gerade / Circlip plier, int, straight 180 mm
Lochschere / Hole cutting snip 250 mm
Dreikant-Hohlschaber / Triangular hollow scraper 200 mm
Flachschaber / Square scraper 200 mm
Stahl-Drahtbürste, 3-reihig / Wire brush 3 rows
Zündkerzenbürste 150 mm / Spark plug brush 150 mm
Werkstattfeile, flachstumpf / Eng file, flat 200 mm
Werkstattfeile, rund / Eng file, round 200 mm
Montiereisen / Tyre lever 400 mm
Isolierband, Länge / Insulated tape, lg 10 m
Kreuzmeißel / Cross cut chisel 150 x 6 mm
Flachmeißel / Flat cold chisel 150 x 18 mm
Durchtreiber / Taper pin punch 3 mm
Körner / Centre punch 120 mm
Splintreiber / Parallel pin punch 150 mm, Gr. 3 · 4 · 5 · 6 mm
Schlosserhammer / Engineers' hammer 300 gr.
Kunststoff-Hammer / Plastic hammer 32 mm Ø



960-7 - 995-8

Module

Werkzeugsortimente in hochwertigen Schaumeinlagen 348 x 188 x 40 mm

Modules

Tool assortments in high quality foam inlays 348 x 188 x 40 mm

Modules

Assortiments d'outils dans inserts en mousse de haute qualité 348 x 188 x 40 mm

Módulos

Surtido de herramientas en insertos de espuma de alta calidad 348 x 188 x 40 mm

960-7

Winkelschraubendreher-Satz

für Innensechskantschrauben

Chrom-Vanadium, C = verchromt

Hexagonal head wrench set

for hexagon socket screws

Chrome-Vanadium, C = chromium plated

Jeux de clés mâles coudées

pour vis à pans creux

Chrome-Vanadium, C = chromées

Juegos de llave Allen, acodadas

para tornillos Allen

Cromo Vanadio, C = cromado



Code	tlg. pcs.	g		EAN
00960001080	7	810	1	141337

enthaltend /containing

Stck. pcs.	Artikel article	No.	Maße dimensions
7		1337	MM 2,5 / 3 / 4 / 5 / 6 / 8 / 10

962-7

Kugelpf-Winkelschraubendreher-Satz

für Innensechskantschrauben

Chrom-Vanadium, C = verchromt

Ball head hexagonal wrench set

for hexagon socket screws

Chrome-Vanadium, C = chromium plated

Tournevis coudé à tête sphérique Peine

pour vis à pans creux

Chrome-Vanadium, C = chromées

Destornillador de punta esférica Oración

para tornillos Allen

Cromo Vanadio, C = cromado



Code	tlg. pcs.	g		EAN
00962001080	7	660	1	425444

enthaltend /containing

Stck. pcs.	Artikel article	No.	Maße dimensions
7		1335	MM 2,5 / 3 / 4 / 5 / 6 / 8 / 10

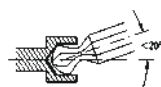

961-7

Winkelschraubendreher-Satz

für Innen-TORX®-Schrauben
Chrom-Vanadium, C = verchromt

Wrench set, "L"-shaped

for TORX®-socket screws
Chrome-Vanadium, C = chromium plated

Jeux de clés mâles coudées

pour vis TORX® intérieures
Chrom-Vanadium, C = chromées

Llaves macho, acodadas

para tornillos TORX® interiores
Cromo Vanadio, C = cromado



Code	tlg. pcs.			EAN
00961001080	7	590	1	141351

enthaltend /containing

Stck. pcs.	Artikel article	No.	Maße dimensions
7		1347	T 10 / 15 / 20 / 25 / 27 / 30 / 40

963-9

DIN 896 B

Rohrsteckschlüssel-Satz

C = verchromt

Tubular socket wrench set

C = chromium plated

Jeux de clés en tube

C = chromées

Juegos de llaves de tubo

C = cromado

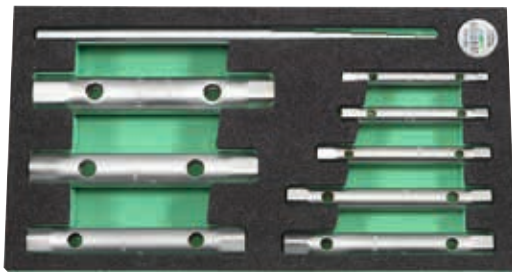

Code	tlg. pcs.			EAN
00963000280	9	1060	1	425451

enthaltend /containing

Stck. pcs.	Artikel article	No.	Maße dimensions
8		896	MM 6 x 7 / 8 x 9 / 10 x 11 / 12 x 13 / 14 x 15 / 16 x 17 / 18 x 19 / 20 x 22
1		1360	Ø 3,2 – 12 mm x 280 mm

966-7

DIN 3118

Offener Doppelringschlüssel-Satz

Chrom-Vanadium, C = verchromt

Flare nut ring wrench set

Chrome-Vanadium, C = chromium plated

Plus ouvert Jeu de clés polygonales doubles

Chrome-Vanadium, C = chromées

Más abierto Juego de llaves dobles

Cromo Vanadio, C = cromado



Code	tlg. pcs.			EAN
00966000280	7	920	1	425512

enthaltend /containing

Stck. pcs.	Artikel article	No.	Maße dimensions
7		497	MM 8 x 10 / 10 x 11 / 11 x 13 / 12 x 14 / 14 x 17 / 17 x 19 / 19 x 22

967-4

DIN 3110/ISO 1085

Doppelmaulschlüssel-Satz

Chrom-Vanadium, CP = verchromt, Köpfe poliert

Double ended open jaw wrench set

Chrome-Vanadium, CP = chromium plated, polished heads

Jeux de clés à fourche

Chrome-Vanadium, CP = chromées, têtes polies

Juegos de llaves fijas de dos bocas abiertas

Cromo Vanadio, CP = cromado, cabezas pulidas espejo



Code	tlg. pcs.			EAN
00967000282	4	1520	1	425727

enthaltend /containing

Stck. pcs.	Artikel article	No.	Maße dimensions
4		350	MM 21 x 23 / 24 x 27 / 25 x 28 / 30 x 32

968-8

Doppelmaulschlüssel-Satz

Chrom-Vanadium, CP = verchromt, Köpfe poliert

Double ended open jaw wrench set

Chrome-Vanadium, CP = chromium plated, polished heads

Jeux de clés à fourche

Chrome-Vanadium, CP = chromées, têtes polies

Juegos de llaves fijas de dos bocas abiertas

Cromo Vanadio, CP = cromado, cabezas pulidas espejo

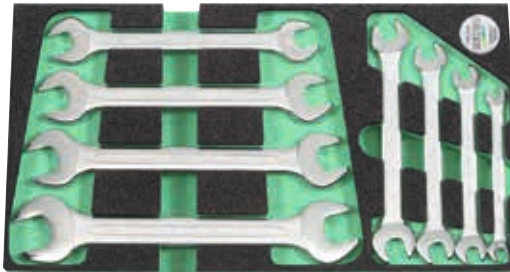

Code	tlg. pcs.			EAN
00968000282	8	950	1	141320

enthaltend /containing

Stck. pcs.	Artikel article	No.	Maße dimensions
8		350	MM 6 x 7 / 8 x 9 / 10 x 11 / 12 x 13 / 14 x 15 / 16 x 17 / 18 x 19 / 20 x 22

970-3

Ringmaulschlüssel-Satz

Chrom-Vanadium, CP = verchromt, Kopf und Ring poliert

Combination wrench set

Chrome-Vanadium, CP = chromium-plated, polished head and ring

Jeux de clés mixtes

Chrome-Vanadium, CP = chromées, têtes polies

Juegos de llaves combinadas

Cromo Vanadio, CP = cromado, cabezas pulidas espejo

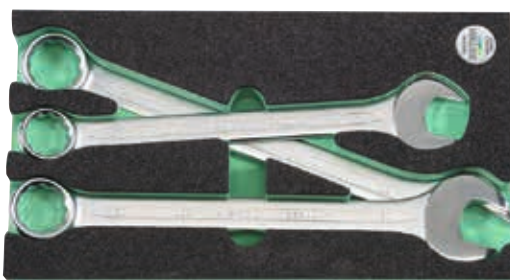

Code	tlg. pcs.			EAN
00970000482	3	1540	1	425734

enthaltend /containing

Stck. pcs.	Artikel article	No.	Maße dimensions
3		400	MM 27 / 30 / 32

971-17

Ringmaulschlüssel-Satz

Chrom-Vanadium, CP = verchromt, Kopf und Ring poliert

Combination wrench set

Chrome-Vanadium, CP = chromium-plated, polished head and ring

Jeux de clés mixtes

Chrome-Vanadium, CP = chromées, têtes polies

Juegos de llaves combinadas

Cromo Vanadio, CP = cromado, cabezas pulidas espejo

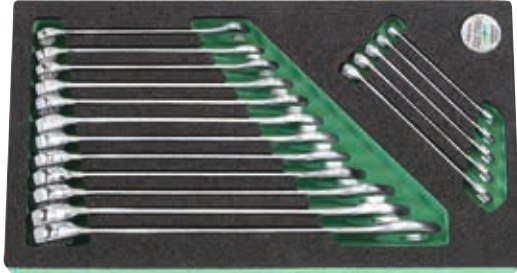

Code	tlg. pcs.			EAN
00971000282	17	1940	1	120745

enthaltend /containing

Stck. pcs.	Artikel article	No.	Maße dimensions
17		400	MM 6 / 7 / 8 / 9 / 10 / 11 / 12 / 13 / 14 / 15 / 16 / 17 / 18 / 19 / 21 / 22 / 24

972-14

Ringmaulschlüssel-Satz maxline

Chrom-Vanadium, CPP = verchromt, ganz poliert

Combination wrench set maxline

Chrome-Vanadium, CPP = chromium plated, fully polished

Jeux de clés mixtes maxline

Chrome-Vanadium, CPP = chromées, entièrement polies

Juegos de llaves combinadas maxline

Cromo Vanadio, CPP = cromado, enteramente pulido espejo



Code	tlg. pcs.			EAN
00972000283	14	2680	1	120752

enthaltend /containing

Stck. pcs.	Artikel article	No.	Maße dimensions
14		410	MM 10 / 11 / 12 / 13 / 14 / 15 / 16 / 17 / 18 / 19 / 20 / 21 / 22 / 24

973-8

Doppelringschlüssel-Satz

Chrom-Vanadium, CP = verchromt, Ringe poliert

Double ended ring wrench set

Chrome-Vanadium, CP = chromium-plated, polished rings

Jeux de clés polygonales

Chrome-Vanadium, CP = chromées, têtes polies

Juegos de llaves de estrella acodadas, de dos bocas

Cromo Vanadio, CP = cromado, cabezas pulidas espejo

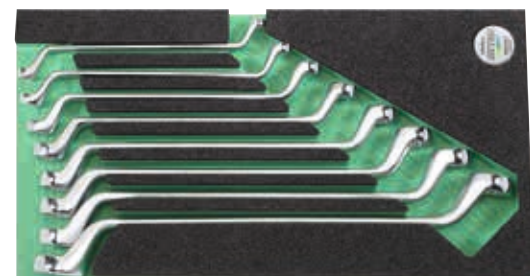

Code	tlg. pcs.			EAN
00973000282	8	1460	1	120769

enthaltend /containing

Stck. pcs.	Artikel article	No.	Maße dimensions
8		475	MM 6 x 7 / 8 x 9 / 10 x 11 / 12 x 13 / 14 x 15 / 16 x 17 / 18 x 19 / 20 x 22

976-42

Steckschlüssel-Garnitur

Chrom-Vanadium, CPP = verchromt, ganz poliert

Socket set

Chrome-Vanadium, CPP = chromium plated, fully polished

Composition de douilles

Chrome-Vanadium, CPP = chromées, entièrement polies

Juegos de llaves de vaso

Cromo Vanadio, CPP = cromado, enteramente pulido espejo



Code	tlg. pcs.			EAN
00976001083	42	860	1	425741

enthaltend /containing

Stck. pcs.	Artikel article	No.	Maße dimensions
13		25-6	MM 4 / 4,5 / 5 / 5,5 / 6 / 7 / 8 / 9 / 10 / 11 / 12 / 13 / 14
1		25-00-15	140 mm – 72 Zähne /teeth/dents/dientes
1		25-03	114 mm
1		25-04	50 mm
1		25-05-1	150 mm
1		25-06	35 mm
1		25-08	145 mm
3		25-30	4 x 0,8 / 5,5 x 1,0 / 8 x 1,2 mm
5		25-31	MM 3 / 4 / 5 / 6 / 8
2		25-32	PH No. 1 2
6		25-20	E 4 / 5 / 6 / 7 / 8 / 10
7		25-36	T 10 / 15 / 20 / 25 / 27 / 30 / 40

977-6

Antriebs- und Verbindungsteile-Satz

Chrom-Vanadium, CPP = verchromt, ganz poliert

Accessories set

Chrome-Vanadium, CPP = chromium plated, fully polished

Ensemble d'accessoires

Chrome-Vanadium, CPP = chromées, entièrement polies

Conjunto de accesorios

Cromo Vanadio, CPP = cromado, enteramente pulido espejo



Code	tlg. pcs.			EAN
00977001083	6	1800	1	425758

enthaltend /containing

Stck. pcs.	Artikel article	No.	Maße dimensions
1		50-00-10	270 mm – 48 Zähne /teeth/dents/dientes
1		50-03	300 mm
3		50-04-1 50-04 50-05	75 mm 125 mm 250 mm
1		50-06	70 mm

978-6-17

Steckschlüssel-Garnitur

Chrom-Vanadium, CPP = verchromt, ganz poliert

Socket set

Chrome-Vanadium, CPP = chromium plated, fully polished

Composition de douilles

Chrome-Vanadium, CPP = chromées, entièrement polies

Juegos de llaves de vaso

Cromo Vanadio, CPP = cromado, enteramente pulido espejo



Code	tlg. pcs.			EAN
00978500683	17	1620	1	425765

enthaltend /containing

Stck. pcs.	Artikel article	No.	Maße dimensions
17		50-6	MM 10 / 11 / 12 / 13 / 14 / 15 / 16 / 17 / 18 / 19 / 21 / 22 / 23 / 24 / 27 / 30 / 32

978-12-17

Steckschlüssel-Garnitur

Chrom-Vanadium, CPP = verchromt, ganz poliert

Socket set

Chrome-Vanadium, CPP = chromium plated, fully polished

Composition de douilles

Chrome-Vanadium, CPP = chromées, entièrement polies

Juegos de llaves de vaso

Cromo Vanadio, CPP = cromado, enteramente pulido espejo

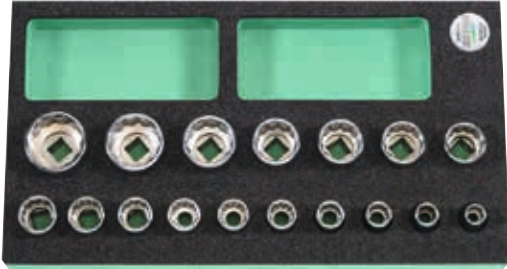

Code	tlg. pcs.			EAN
00978501283	17	1620	1	425796

enthaltend /containing

Stck. pcs.	Artikel article	No.	Maße dimensions
17		50-12	MM 10 / 11 / 12 / 13 / 14 / 15 / 16 / 17 / 18 / 19 / 21 / 22 / 23 / 24 / 27 / 30 / 32

979-19-13

Steckschlüssel-Garnitur, extra lang

Chrom-Vanadium, CP = verchromt, teilweise poliert

Socket set, extra deep

Chrome-Vanadium, CP = chromium plated, partially polished

Composition de douilles, extra longues

Chrome-Vanadium, CP = chromées, partiellement polies

Juegos de llaves de vaso, extra largo

Cromo Vanadio, CP = cromado, cabeza pulida espejo

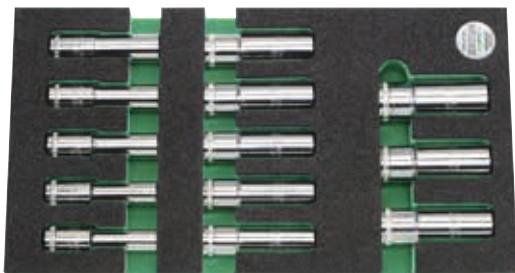

Code	tlg. pcs.			EAN
00979501983	13	1660	1	425802

enthaltend /containing

Stck. pcs.	Artikel article	No.	Maße dimensions
13		50-19	MM 10 / 11 / 12 / 13 / 14 / 15 / 16 / 17 / 18 / 19 / 21 / 22 / 24

981-15

Satz mit Schraubendreher-Einsätzen

Körper = Chrom-Vanadium, CPP = verchromt, ganz poliert

Bits = Sonderstahl, PH = phosphatiert

Set with screwdriver sockets

Socket bodies = Chrome-Vanadium, CPP = chromium plated, fully polished

Bits = special steel, PH = phosphated

Jeux de douilles tournevis

Douilles = Chrome-Vanadium, CPP = chromées, entièrement polies

Embouts = Acier Spécial, PH = phosphaté

Juegos de llaves de vaso con destornillador

Cuerpo = Cromo Vanadio, CPP = cromado, enteramente pulido espejo

Puntas = Acero aleado, PH = fosfatado

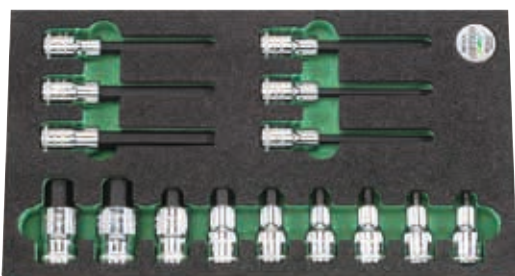

Code	tlg. pcs.			EAN
00981503183	15	1620	1	425819

enthaltend /containing

Stck. pcs.	Artikel article	No.	Maße dimensions
7		50-31 (52 mm)	MM 5 / 6 / 7 / 8 / 10 / 12 / 14
2		50-31 (60 mm)	MM 17 / 19
6		50-31 (120 mm)	MM 5 / 6 / 7 / 8 / 10 / 12

982-18

Satz mit Schraubendreher-Einsätzen

für Innen TORX® Schrauben
Körper = Chrom-Vanadium, CPP = verchromt, ganz poliert
Bits = Sonderstahl, PH = phosphatiert

Set with screwdriver sockets

for TORX®-socket screws
Socket bodies = Chrome-Vanadium, CPP = chromium plated, fully polished
Bits = special steel, PH = phosphated

Jeux de douilles tournevis

pour vis TORX® intérieures
Douilles = Chrome-Vanadium, CPP = chromées, entièrement polies
Embouts = Acier Spécial, PH = phosphaté

Juegos de llaves de vaso con destornillador

para tornillos TORX® interiores
Cuerpo = Cromo Vanadio, CPP = cromado, enteramente pulido espejo
Puntas = Acero aleado, PH = fosfatado

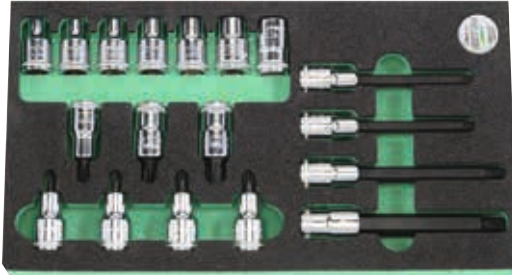

Code	tlg. pcs.			EAN
00982503683	18	1600	1	425826

enthaltend /containing

Stck. pcs.	Artikel article	No.	Maße dimensions
7		50-20	E 10 / 11 / 12 / 14 / 16 / 18 / 20
7		50-36 (55/58)	T 27 / 30 / 40 / 45 / 50 / 55 / 60
4		50-36 (120/140)	T 40 / 45 / 50 / 55

983-23

DIN 3129 / ISO 2725

IMPACT-Steckschlüssel-Garnitur

Chrom Molybdän, PH = phosphatiert

IMPACT-Socket set

Chrome molybdenum, PH = phosphated

IMPACT Compositions de douilles

Chrome molybdène, PH = phosphatées

Juegos de llaves de vaso de IMPACTO

Cromo molibdeno, PH = fosfatado



Code	tlg. pcs.			EAN
00983630036	23	3760	1	425833

enthaltend /containing

Stck. pcs.	Artikel article	No.	Maße dimensions
16		6300	MM 10 / 11 / 12 / 13 / 14 / 15 / 16 / 17 / 18 / 19 / 21 / 22 / 24 / 27 / 30 / 32
4		6300-19	MM 17 / 19 / 21 / 22
2		6301-2/4	125 mm, 250 mm
1		6301-10	60 mm

990-4

Zangen-Satz

CPI = verchromt, Kopf poliert,
formel plus Kunststoffgriffe mit Abgleitschutz

Set of pliers

CPI = chromium plated, polished head,
formel plus plastic handles with slip guard

Jeux de pinces

CPI = chromées, têtes polies, branches
formel plus gainées plastique, antiglissant

Juegos de alicates

CPI = cromado, cabeza pulida, fundas de plástico
formel plus, con tope salvamanos



Code	tlg. pcs.			EAN
00990001086	4	1180	1	120806

enthaltend /containing

Stck. pcs.	Artikel article	No.	Maße dimensions
1		1200 CPI	180 mm
1		1208 CPI	200 mm
1		1213 CPI	160 mm
1		1220 CPI	160 mm

990-4-1

VDE Zangen-Satz

CPV = verchromt, Kopf poliert, Isoliergriffhüllen
IEC 900/DIN EN 60900/VDE 0682 Teil 201

Set of pliers VDE

CPV = chromium plated, polished head, VDE insulated handles
IEC 900/DIN EN 60900/VDE 0682 part 201

VDE Jeux de pinces

CPV = chromées, tête polie, branches isolés, antiglissant
IEC 900/DIN EN 60900/VDE 0682 paragraphe 201

VDE Juegos de alicates

CPV = cromado, cabeza pulida, fundas aislantes
IEC 900/DIN EN 60900/VDE 0682 apartado 201



Code	tlg. pcs.			EAN
00990002088	4	1200	1	120813

enthaltend /containing

Stck. pcs.	Artikel article	No.	Maße dimensions
1		1200 VDE	180 mm
1		1208 VDE	200 mm
1		1213 VDE	160 mm
1		1220 VDE	160 mm



991-7

2-K Schraubendreher-Satz

Chrom-Vanadium, C = verchromt

2-K Screwdriver set

Chrome-Vanadium, C = chromium plated

2-K Jeux de tournevis

Chrome-Vanadium, C = chromées

Juegos de destornilladores 2-K

Cromo Vanadio, C = cromado

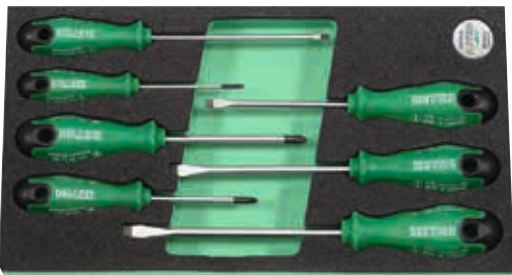

Code	tlg. pcs.			EAN
00991001580	7	885	1	167535

enthaltend /containing

Stck. pcs.	Artikel article	No.	Maße dimensions
2		4511 C	PH No. 1 2
3		4530 C	5,5 x 100 mm 6,5 x 125 mm 8 x 150 mm
2		4535 C	3 x 75 mm 4 x 125 mm

991-8

Schraubendreher-Satz

Chrom-Vanadium, C = verchromt

Screwdriver set

Chrome-Vanadium, C = chromium plated

Jeux de tournevis

Chrome-Vanadium, C = chromées

Juegos de destornilladores

Cromo Vanadio, C = cromado

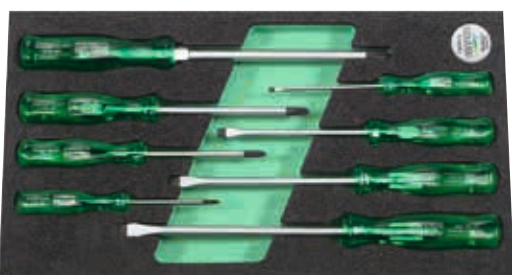

Code	tlg. pcs.			EAN
00991001080	8	820	1	120820

enthaltend /containing

Stck. pcs.	Artikel article	No.	Maße dimensions
4		1411	PH No. 0 1 2 3
3		1430	5,5 x 100 mm 6,5 x 125 mm 8 x 150 mm
1		1435	3 x 75 mm

991-8-1

VDE Schraubendreher-Satz

Chrom-Vanadium, BV = brüniert, schutzisoliert gemäß DIN EN 60900 mit eingespritzt ummantelter Klinge, mit schlagfestem Kunststoffheft

VDE Screwdriver set

Chrome-Vanadium, BV = gun-metal finish, insulated, complying with DIN EN 60900, insulation of blade, and handle injection moulded as one unit, with shockproof plastic handle

VDE Jeux de tournevis

Chrome Vanadio, BV = pavonado, isolé, conforme aux spécifications VDE 0680/2, isolation de la lame par injection, manche en matière plastique incassable

VDE Juegos de destornilladores

Cromo Vanadio, BV = pavonado, mangos con funda de plástico, protección cumple EN 60900, aislamiento de la varilla inyectado, mango de plástico antichoque

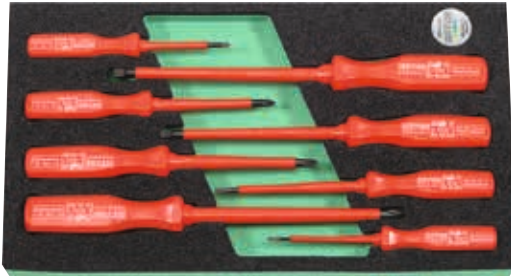

Code	tlg. pcs.	g	1	EAN
00991002033	8	660	1	120837

enthaltend /containing

Stck. pcs.	Artikel article	No.	Maße dimensions
4	1411 VDE	1411 VDE	PH No. 0 1 2 3
4	1436 VDE	1436 VDE	2,5 x 75 mm 4 x 100 mm 5,5 x 125 mm 6,5 x 150 mm



1000 Volt

991-8-2

VDE Schraubendreher-Satz 2-K

Chrom-Vanadium, BV = brüniert, schutzisoliert gemäß DIN EN 60900 mit eingespritzt ummantelter Klinge, mit schlagfestem Kunststoffheft

VDE Screwdriver set

Chrome-Vanadium, BV = gun-metal finish, insulated, complying with DIN EN 60900, insulation of blade, and handle injection moulded as one unit, with shockproof plastic handle

VDE Jeux de tournevis

Chrome-Vanadium, BV = brüniert, isolé, conforme aux spécifications VDE 0680/2, isolation de la lame par injection, manche en matière plastique incassable

VDE Juegos de destornilladores

Cromo Vanadio, BV = pavonado, mangos con funda de plástico, protección cumple EN 60900, aislamiento de la varilla inyectado, mango de plástico antichoque



Code	tlg. pcs.	g	1	EAN
00991003033	8	560	1	425840

enthaltend /containing

Stck. pcs.	Artikel article	No.	Maße dimensions
3	4511 VDE	4511 VDE	PH No. 1 2 3
4	4536 VDE	4536 VDE	2,5 x 75 mm 4 x 100 mm 5,5 x 125 mm 6,5 x 150 mm
1	1427 VDE	1427 VDE	3 x 60 mm



1000 Volt

991-9

2-K Schraubendreher-Satz für Innen-TORX®-Schrauben

Molybdän-Vanadium C = verchromt (mit schwarzer Spitze)

2-K Screwdriver set for TORX®-Socket screws

Molybdenum-Vanadium, C = chromium plated (with black tip)

2-K Jeux de tournevis pour vis TORX® intérieures

Molybdène-Vanadium, C = chromées (avec extrémité brunie)

Juegos de destornilladores para tornillos TORX® interiores 2-K

Molibdeno Vanadio, C = varilla cromada con punta pavonada



Code	tlg. pcs.	g	1	EAN
00991451580	9	640	1	425857

enthaltend /containing

Stck. pcs.	Artikel article	No.	Maße dimensions
9	4515	4515	T 8 / 9 / 10 / 15 / 20 / 25 / 27 / 30 / 40

992-4

Zangen-Satz für Sicherungsringe

Chrom-Vanadium, CPD = verchromt, Kopf poliert, Griffe kunststoffbeschichtet

Set of circlip pliers

Chrome-Vanadium, CPD = chromium plated, polished head, plastic coated handles

Jeux de pinces pour circlips

Chrome-Vanadium, CPD = chromées, articulation polie, branches gainées plastique

Juegos de alicates para arandelas

Cromo Vanadio, CPD = cromado, unión pulida, mangos plastificados

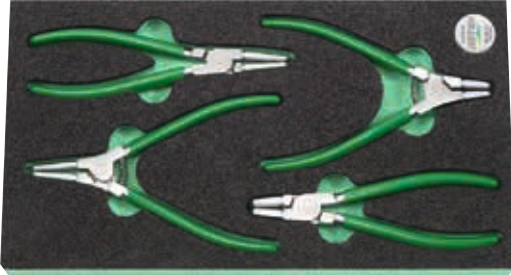

Code	tlg. pcs.			EAN
00992000087	4	820	1	147452

enthaltend /containing

Stck. pcs.	Artikel article	No.	Maße dimensions
1		1250 CPD	175 mm gerade für Außensicherung 175 mm for external circlips, straight
1		1252 CPD	165 mm gebogen für Außensicherung 165 mm for external circlips, bent
1		1255 CPD	180 mm gerade für Innensicherung 180 mm for internal circlips, straight
1		1256 CPD	170 mm gebogen für Innensicherung 170 mm for internal circlips, bent



993-7

Schraubendreher-Satz

Chrom-Vanadium, C = verchromt (mit schwarzer Spitze) mit durchgehender Klinge und Hartholzheft mit Lederkappe Klinge mit Sechskant

Screwdriver set

Chrome-Vanadium, C = chromium plated (with black tip) with blade through handle and hardwood handle with leather cap blade with hexagon bolster

Jeux de tournevis

Chrome-Vanadium, C = chromées (extrémité noire) lame traversante et manche en bois dur avec une bague en cuir lame avec un six pans

Juegos de destornilladores

Cromo Vanadio, C = cromado (con punta negra) varilla pasante y mango de madera con remate de cuero, varilla con hexágono



Code	tlg. pcs.			EAN
00993001080	7	720	1	425871

enthaltend /containing

Stck. pcs.	Artikel article	No.	Maße dimensions
3		1405	PH No. 1 2 3
4		1470	3,5 x 75 mm 7 x 125 mm 5,5 x 100 mm 8 x 150 mm

994-2

Hammer-Satz

Hammer set

Ensemble de marteau

Conjunto de martillo



Code	tlg. pcs.			EAN
00994001000	2	1100	1	425864

enthaltend /containing

Stck. pcs.	Artikel article	No.	Maße dimensions
1		1520	500 g
1		1530	Ø 30 mm

995-8

Werkzeug-Satz

Chrom-Vanadium, LS = lackiert, teilweise geschliffen

Tool set

Chrome-Vanadium, LS = lacquered, partly ground

Jeux d'outils



Chrome-Vanadium, LS = laquées, partiellement meulé

Conjunto de herramientas

Cromo Vanadio, LS = barnizado, parcialmente pulido

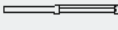

Code	tlg. pcs.			EAN
00995000021	8	1730	1	141306

enthaltend /containing			
Stck. pcs.	Artikel article	No.	Maße dimensions
2		1555	150 mm 200 mm
4		1565	Ø 3 4 5 6 x 150 mm
1		1575	Ø 4 x 120 mm
1		1520	500 g

996-6

Radwechsel-Werkzeugsatz



Wheel changing tool set

Kit démontage de roues

Juego de herramientas para cambio de rueda

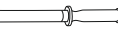

Code	tlg. pcs.			EAN
00996001000	6	1540	1	425888

enthaltend /containing			
Stck. pcs.	Artikel article	No.	Maße dimensions
1		1233	260 mm
4	 	6300-18	MM 17 / 19 / 21 / 22
1		1512	280 mm

997-6

DIN 7261/ISO 234/1

Feilen-Satz

ST = standardmäßig, Hieb 2 – halbschlicht, Kreuzhieb

Files set

ST = standard, second cut, cross-cut

Ensemble de fichiers



ST = standard, demi-douce, à taille double

Conjunto de archivos

ST = estándar, talla 2 – entrefina, talla doble



Code	tlg. pcs.			EAN
00997001000	11	760	1	425895

enthaltend /containing			
Stck. pcs.	Artikel article	No.	Maße dimensions
5 + 5		1675-1679	200 mm + Feilenhefte / File handles
1		1754	260 mm

999-6

Messwerkzeuge-Satz

Measuring tool set

Ensemble d'outils de mesure

Conjunto de herramientas de medición



Code	tlg. pcs.			EAN
00999001000	6	820	1	425918

enthaltend /containing			
Stck. pcs.	Artikel article	No.	Maße dimensions
1		1806	155 mm
1		1814-4	0.05 - 1.0 mm
1		1836	300 mm
1		1837	200 mm
1		1840-5	500 mm
1		1842	250 mm

1090

Kofflügelschoner

Aus Nylon und selbsthaftendem Non-slip-Material, schwarz mit grüner Einfassung. Haftet auf allen Materialien und Untergründen. Unbedenklich für alle Lacke. Ölabweisend. Voll waschbar. Schützt zuverlässig vor Beschädigungen.

Fender cover

Made from high-strength nylon and self-adhesive non-slip material. Adheres to all materials and backings. Convenient for all points. Repellent to oil. Fully washable. Reliable protection against damages.

Couverture garde-boue#

En nylon et matériau auto-adhésif antidérapant, noir avec ruban vert. Adhère à tous les matériaux et supports. Sans danger pour toutes les peintures. Oléophobe. Entièrement lavable. Protège contre les dégâts.

Cubrealetas

De nylon antideslizante, color negro con ribete verde. Se adhiere a todo tipo de material. No daña la pintura. Repele el aceite. Totalmente lavable. Protección contra raspaduras.



Code	Maße dimensions	g	Icon	EAN
01090000000	860 x 480 mm	315	1	334371



Auch für moderne Karosserien aus Aluminium und Kunststoff geeignet. Also suitable for modern car bodies from aluminium and synthetic materials.

1090-1

Kniebrett

- Feuchtigkeits- und schmutzabweisend
- Mit integriertem Tragegriff
- Resistent gegen: Öl, Benzin und Chemikalien
- Individuell einsetzbar
- Kleidung, sowie Knie bleiben sauber und trocken

Kneeling mat

- Repellent to moisture and dirt
- With integrated carrying handle
- Resistant against: oil, petrol and chemicals
- Multiple use
- Clothing and knees remain clean and dry

Planchette pour les genoux

- Résistant à l'humidité et aux taches
- Avec poignée intégrée
- Résistant à l'huile, l'essence et les produits chimiques
- Peuvent être utilisés individuellement
- Les vêtements et les genoux restent propres et secs

Plancha para trabajar de rodillas

- Repele humedad y suciedad
- Con asa integrada
- Resistente a aceites, carburantes y productos químicos
- De uso individual
- Mantiene limpios y secos vestimenta y rodillas

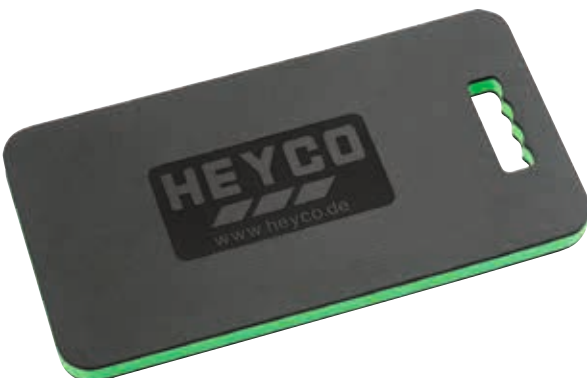

Code	Maße dimensions	g	Icon	EAN
01090000100	480 x 250 x 30 mm	130	1	336702

ZANGEN

PLIERS

148-153 Seite/page

Zangen
Pliers
Pincas
Alicates

154-158 Seite/page

VDE Zangen & Sortiment
VDE Pliers & assortment
VDE Pincas & assortment
VDE Alicates & juego de herramientas

159-162 Seite/page

Spezialzangen
Special pliers
Tenazas especiales
Pincas spéciales

162-164 Seite/page

Nietzange und Zubehör
Rivet tool and accessoires
Pincas à riveter et accessoires
Tenazas de remachar y accesorios

165-166 Seite/page

Gripzangen
Grip pliers
Pincas-étaux
Tenazas grip

166-167 Seite/page

Bandschlüssel und Rohrzangen
Strap wrenches and pipe wrenches
Clés à sangle et serre-tubes
Llaves de correa y llaves para tubos





ZANGEN PROGRAMM

PLIERS PROGRAM

Starker Chrom-Vanadium Stahl
Schneiden induktiv gehärtet
Kunststoffgriffe mit Abgleitschutz
Sicherheitswerkzeuge
IEC 900/DIN EN 60900

Strong chrome vanadium steel
Cutting edges induction hardened
Plastic handle with slip guard
Insulated safety tools
IEC 900/DIN EN 60900

Resistente acero al cromo vanadio
Bordes de corte endurecidos por inducción
Mango de plástico con protección antideslizante
Herramientas de seguridad aisladas
IEC 900/DIN EN 60900

Acier solide au chrome vanadium
Tranches de coupe trempées par induction
Poignée en plastique avec protection antidérapante
Outils de sécurité isolés
IEC 900/DIN EN 60900

300

DIN ISO 8976

Wasserpumpenzangen

Chrom-Vanadium,
CP = verchromt, Kopf poliert,
CPI = verchromt, Kopf poliert, Kunststoffgriffe
mit Abgleitschutz mit aufgelegtem Gleitgelenk

Water pump pliers

Chrome-Vanadium,
CP = chromium plated, polished head,
CPI = chromium plated, polished head,
plastic handle with slip guard, with slip joint

Pinces multiprises

Chrome-Vanadium,
CP = chromées, tête polie,
CPI = chromées, tête polie, branches gainées plastique,
antiglissant charnière glissière

Tenazas de abertura múltiple

Cromo Vanadio,
CP = cromado, cabeza pulida espejo,
CPI = cromado, cabeza pulida espejo,
fundas de plástico con tope salvamanos unión simple

Code	Ausf./finish	←L→		g	g	EAN
		mm	"			
00300024082	CP	240	9.1/2	275	1	008029
00300024086	CPI	240	9.1/2	350	1	008036



CP



CPI

313

DIN ISO 8976

Wasserpumpenzangen

Chrom-Vanadium,
LS = lackiert, Kopf geschliffen
mit durchgestecktem Gleitgelenk

Water pump pliers

Chrome-Vanadium,
LS = lacquered, ground head
with box joint

Pinces multiprises

Chrome-Vanadium,
LS = laquées, tête meulée
charnière entrepassée et glissière

Tenazas de abertura múltiple

Cromo Vanadio,
LS = barnizado, cabeza amolada
unión machihembrada

Code	mm	←L→		g	g	EAN
		mm	"			
00313017521	175		7	160	1	008142
00313024021	240		9.1/2	285	1	008166



316

DIN ISO 8976

Wasserpumpenzange

Chrom-Vanadium,
tauchisoliert, schnelles Einstellen per Druckknopf,
verstärkte Selbstklemmung durch optimierte Maulgestaltung

Water plump pliers

Chrome-Vanadium,
plastic coated handles, quick setting by push-button directly at
workpiece, enhanced self-locking effect by optimised jaw design

Pinces multiprises

Chrome-Vanadium,
poignées isolées, réglage rapide par bouton-poussoir directement sur
la pièce, effet autobloquant amélioré grâce à la conception optimisée
de la mâchoire

Tenazas de abertura múltiple

Cromo Vanadio,
mangos plastificados, ajuste rápido mediante botón pulsador
directamente en la pieza de trabajo, efecto autoapriete mejorado
gracias al diseño optimizado de la mordaza

Code	←L→		g	g	EAN
	mm	"			
00316018087	180	7	180	1	448511
00316025087	250	10	335	1	448528

Vergrößerte Greifweite: Rohre 2",
Muttern 46 mm.
extended gripping width: pipes 2",
nuts 46 mm.



1200

DIN ISO 5746

Kombinationszangen

CPD = verchromt, Kopf poliert, Griffe kunststoffbeschichtet
CPI = verchromt, Kopf poliert, Kunststoffgriffe mit Abgleitschutz,
mit Facetten, mit zusätzlich induktiv gehärteten Schneiden,
für mittelharten Draht

Combination pliers

CPD = chromium plated, polished head, plastic coated handles
CPI = chromium plated, polished head, plastic handle with slip guard,
with facets, cutting edges additionally induction hardened,
for middlehard wire

Pinces universelles, type «mécanicien»

CPD = chromées, tête polie, branches gainées plastique
CPI = chromées, tête polie, branches gainées plastique, antiglissant,
avec facettes en biseau, trempage complémentaire des tranchants par
induction pour fil de dureté moyenne

Alicates universales

CPD = cromado, cabeza pulida espejo, mangos plastificados
CPI = cromado, cabeza pulida espejo, fundas de plástico con tope,
salvamanos, grafilados, cortantes templados por inducción, para
alambre semi-duro

Code	Ausf. finish	←L→		Ø mm	g	g	EAN
		mm	"				
01200016087	CPD	160	6.1/4	1,8	165	1	146899
01200018087	CPD	180	7	2,5	230	1	146882
01200020087*	CPD	200	8	2,5	275	1	146875
01200016086	CPI	160	6.1/4	1,8	195	1	146844
01200018086	CPI	180	7	2,5	265	1	146851
01200020086*	CPI	200	8	2,5	310	1	146868



CPD



CPI

1206

DIN ISO 5745

Flachzangen

CPD = verchromt, Kopf poliert, Griffe kunststoffbeschichtet
 CPI = verchromt, Kopf poliert, Kunststoffgriffe mit Abgleitschutz, mit langen Backen und gezahnten Greifflächen

Flat nose pliers

CPD = chromium plated, polished head, plastic coated handles
 CPI = chromium plated, polished head, plastic handle with slip guard, with long serrated jaws

Pinces à becs plats

CPD = chromées, tête polie, branches gainées plastique
 CPI = chromées, tête polie, branches gainées plastique, antiglissant, à becs longs et surfaces de prise striées

Alicates boca plana larga

PD = cromado, cabeza pulida espejo, mangos plastificados
 CPI = cromado, cabeza pulida espejo, fundas de plástico, con tope salvamanos, bocas largas con dentado



CPD



CPI

Code	Ausf./finish	←L→		g	g	EAN
		mm	"			
01206016087	CPD	160	6.1/4	120	1	146561
01206016086	CPI	160	6.1/4	135	1	023411

1207

DIN ISO 5745

Rundzangen

CPD = verchromt, Gelenk poliert, Griffe kunststoffbeschichtet
 CPI = verchromt, Gelenk poliert, Kunststoffgriffe mit Abgleitschutz, mit langen Backen

Round nose pliers

CPD = chromium plated, joint area polished, plastic coated handles
 CPI = chromium plated, joint area polished, plastic handle, with slip guard, with long jaws

Pinces à becs ronds

CPD = chromées, articulation meulée, branches gainées plastique
 CPI = chromées, articulation meulée, branches gainées plastique, antiglissant, avec becs longs

Alicates boca redonda larga

CPD = cromado, cabeza pulida espejo, mangos plastificados
 CPI = cromado, cabeza pulida espejo, fundas de plástico, con tope salvamanos, bocas largas

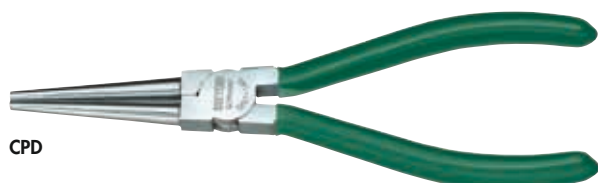

CPD



CPI

Code	Ausf./finish	←L→		g	g	EAN
		mm	"			
01207016087	CPD	160	6.1/4	105	1	146585
01207016086	CPI	160	6.1/4	130	1	023459

1208

DIN ISO 5745

Flachrundzangen, gerade

CPD = verchromt, Kopf poliert, Griffe kunststoffbeschichtet
 CPI = verchromt, Kopf poliert, Kunststoffgriffe mit Abgleitschutz, mit zusätzlich induktiv gehärteten Schneiden, mit langen Backen und gezahnten Greifflächen, mit gezahnter Aussparung, für mittelharten Draht

Snipe nose pliers, straight

CPD = chromium plated, polished head, plastic coated handles
 CPI = chromium plated, polished head, plastic handle with slip guard, with cutting edges additionally induction hardened, with long serrated jaws, with serrated pipe grip

Pinces à becs demi-ronds, droits

CPD = chromées, tête polie, branches gainées plastique
 CPI = chromées, tête polie, branches gainées plastique, antiglissant, avec trempage complémentaire des tranchants par induction, avec becs longs et surfaces de prise striées, avec serre-tube, code présentation Ø pour fil de dureté moyenne

Alicates boca semirredonda, recta

CPD = cromado, cabeza pulida espejo, mangos plastificados
 CPI = cromado, cabeza pulida espejo, fundas de plástico con tope salvamanos, cortantes templados por inducción, para alambre semi-duro, bocas largas con dentado



CPD



CPI

Code	Ausf. finish	←L→		Ø mm	g	g	EAN
		mm	"				
01208014087	CPD	140	5.1/2	1,6	100	1	146707
01208016087	CPD	160	6.1/4	1,6	110	1	146691
01208020087	CPD	200	8	1,8	160	1	146684
01208014086	CPI	140	5.1/2	1,6	120	1	146738
01208016086	CPI	160	6.1/4	1,6	135	1	146721
01208020086	CPI	200	8	1,8	190	1	023565

1209

DIN ISO 5745

Flachrundzangen, 45° abgewinkelt

CPD = verchromt, Kopf poliert, Griffe kunststoffbeschichtet
 CPI = verchromt, Kopf poliert, Kunststoffgriffe mit Abgleitschutz, mit zusätzlich induktiv gehärteten Schneiden, mit langen Backen und gezahnten Greifflächen, mit gezahnter Aussparung, für mittelharten Draht

Snipe nose pliers, 45° angle

CPD = chromium plated, polished head, plastic coated handles
 CPI = chromium plated, polished head, plastic handle with slip guard, with cutting edges additionally induction hardened, with long serrated jaws, with serrated pipe grip

Pinces à becs demi-ronds, coudés à 45°

CPD = chromées, tête polie, branches gainées plastique
 CPI = chromées, tête polie, branches gainées plastique, antiglissant, avec trempage complémentaire des tranchants par induction, avec becs longs et surfaces de prise striées, avec serre-tube, pour fil de dureté moyenne

Alicates boca semirredonda, curva a 45°

CPD = cromado, cabeza pulida espejo, mangos plastificados
 CPI = cromado, cabeza pulida espejo, fundas de plástico con tope salvamanos, cortantes templados por inducción, para alambre semi-duro, bocas largas con dentado

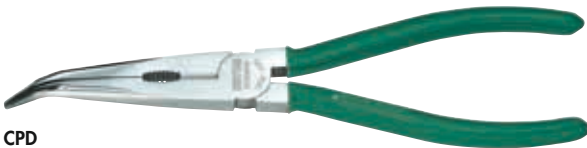

CPD



CPI

Code	Ausf. finish	←L→		Ø mm	g	g	EAN
		mm	"				
01209020087	CPD	200	8	1,8	160	1	146806
01209020086	CPI	200	8	1,8	190	1	023619

1212

DIN ISO 5749

Kraftseitenschneider

CPD = verchromt, Kopf poliert, Griffe kunststoffbeschichtet
CPI = verchromt, Kopf poliert, Kunststoffgriffe mit Abgleitschutz, Schneiden zusätzlich induktiv gehärtet, für harten Draht (Piano-Draht)

Diagonal cutting nippers

Special steel, CPD = chromium plated, polished head, plastic coated handles, CPI = chromium plated, polished head, plastic handle, with slip guard, cutting edges additionally induction hardened, for piano wire

Pinces coupantes diagonales

Acier spécial, CPD = chromées, tête polie, branches gainées plastique
CPI = chromées, tête polie, branches gainées plastique, antiglissant, avec trempage complémentaire des tranchants par induction, pour fil dur (corde à piano)

Alicates cortalambres, corte diagonal, modelo reforzado



Acero especial, CPD = cromado, cabeza pulida espejo, mangos plastificados, CPI = cromado, cabeza pulida espejo, fundas de plástico con tope salvamanos, cortantes templados por inducción, para alambre duro (cuerda de piano)



CPD



CPI

Code	Ausf. finish	←L→			Ø mm			EAN
		mm	"					
01212014087*	CPD	140	5.1/2		1,8	115	1	146769
01212016087	CPD	160	6.1/4		2,0	160	1	146752
01212020087*	CPD	200	8		2,5	295	1	146745
01212014086*	CPI	140	5.1/2		1,8	140	1	146776
01212016086	CPI	160	6.1/4		2,0	195	1	146783
01212020086*	CPI	200	8		2,5	345	1	023831

1213

DIN ISO 5749

Seitenschneider, schwedische Form

CPD = verchromt, Kopf poliert, Griffe kunststoffbeschichtet
CPI = verchromt, Kopf poliert, Kunststoffgriffe mit Abgleitschutz, Schneiden zusätzlich induktiv gehärtet, für mittelharten Draht

Diagonal cutting nippers, swedish pattern

CPD = chromium plated, polished head, plastic coated handles
CPI = chromium plated, polished head, plastic handle with slip guard, cutting edges additionally induction hardened, for middlehard wire

Pinces coupantes diagonales, modèle suédois

CPD = chromées, tête polie, branches gainées plastique
CPI = chromées, tête polie, branches gainées plastique, antiglissant, avec trempage complémentaire des tranchants par induction, pour fil dur

Alicates cortalambres, corte diagonal, modelo sueco



CPD = cromado, cabeza pulida espejo, mangos plastificados
CPI = cromado, cabeza pulida espejo, fundas de plástico con tope salvamanos, cortantes templados por inducción, para alambre semi-duro



CPD



CPI

Code	Ausf. finish	←L→			Ø mm			EAN
		mm	"					
01213012587	CPD	125	5		1,5	90	1	146660
01213014087*	CPD	140	5.1/2		1,8	120	1	146653
01213016087	CPD	160	6.1/4		2,0	165	1	146646
01213012586	CPI	125	5		1,5	110	1	146639
01213014086*	CPI	140	5.1/2		1,8	150	1	146622
01213016086	CPI	160	6.1/4		2,0	205	1	023930

1215

DIN ISO 5748

Kraftvornsneider

Spezialstahl, CPD = verchromt, Kopf poliert, Griffe kunststoffbeschichtet
 CPI = verchromt, Kopf poliert, Kunststoffgriffe mit Abgleitschutz,
 Schneiden zusätzlich induktiv gehärtet, für harten Draht (Piano-Draht)

End cutting nippers



Special steel, CPD = chromium plated, polished head, plastic coated handles, CPI = chromium plated, polished head, plastic handle, with slip guard, cutting edges additionally induction hardened, for piano wire

Pinces coupantes devant

Acier spécial, CPD = chromées, tête polie, branches gainées plastique
 CPI = chromées, tête polie, branches gainées plastique, antiglissant, avec trempage complémentaire des tranchants par induction, pour fil dur (corde à piano)

Alicates cortalambres, corte frontal

Acero especial, CPD = cromado, cabeza pulida espejo, mangos plastificados, CPI = cromado, cabeza pulida espejo, fundas de plásticos con tope salvamanos, cortantes templados por inducción, para alambre duro (cuerda de piano)

Code	Ausf. finish	←L→		 Ø	 g		EAN
		mm	"				
01215016087*	CPD	160	6.1/4	2,2	170	1	146790
01215016086*	CPI	160	6.1/4	2,2	205	1	023985



CPD



CPI

1220

Abisolierzange

CPI = verchromt, Kopf poliert, Kunststoffhüllen mit Abgleitschutz, mit Stellschraube und Öffnungsfeder

Wire stripping plier



CPI = chromium plated, polished head, plastic handle with slip guard, with adjusting screw and spring

Pinces à dénuder

CPI = chromées, tête polie, branches gainées plastique, antiglissant, avec vis de réglage de butée et ressort d'ouverture

Alicates pelacables

CPI = cromado, cabeza pulida espejo, fundas de plástico con tope, salvamanos, con tornillo de ajuste y muelle de apertura

Code	←L→		 Ø	 g		EAN
	mm	"				
01220016086*	160	6.1/4	1,1 – 4,8	180	1	024081



SICHERHEITSWERKZEUGE

INSULATED SAFETY TOOLS



1000 Volt/IEC 900/DIN EN 60900/VDE 0682 Teil 201
1000 Volt/IEC 900/DIN EN 60900/VDE 0682 part 201

1200

DIN ISO 5746

VDE Kombinationszangen

CPV = verchromt, Kopf poliert, Isoliergriffhüllen
IEC 900/DIN EN 60900/VDE 0682 Teil 201,
Schneiden zusätzlich induktiv gehärtet, für mittelharten Draht

VDE Combination pliers



CPV = chromium plated, polished head, VDE insulated handles, IEC 900/DIN EN 60900/VDE 0682 part 201, Cutting edges additionally induction hardened, for middlehard wire

VDE Pincés universelles, type «mécanicien»

CPV = chromées, tête polie, branches gaines isolées
IEC 900/DIN EN 60900/VDE 0682 paragraphe 201, avec trempage complémentaire des franchants par induction, pour fil dur

VDE Alicates universales

CPV = cromado, cabeza pulida espejo, fundas aislantes según IEC 900/DIN EN 60900/VDE 0682 apartado 201, cortantes templados por inducción, para alambre semi-duro

Code	←L→		 Ø			EAN
	mm	"	mm	g		
01200016088	160	6.1/4	1,8	200	1	146837
01200018088	180	7	2,5	275	1	146820
01200020088	200	8	2,5	320	1	146813



1000 Volt



1206

DIN ISO 5745

VDE Flachzange

CPV = verchromt, Kopf poliert, Isoliergriffhüllen
IEC 900/DIN EN 60900/VDE 0682 Teil 201,
mit langen Backen und gezahnten Greifflächen

VDE Long flat nose plier

CPV = chromium plated, polished head, VDE insulated handles, IEC 900/DIN EN 60900/VDE 0682 part 201 with long serrated jaws

VDE Pincés à becs plats

CPV = chromées, tête polie, branches gaines isolées
IEC 900/DIN EN 60900/VDE 0682 paragraphe 201, à becs longs et surfaces de prise striées

VDE Alicates boca plana larga

CPV = cromado, cabeza pulida espejo, fundas aislantes según IEC 900/DIN EN 60900/VDE 0682 apartado 201, bocas largas con dentado

Code	mm	←L→	"			EAN
01206016088	160		6.1/4	140	1	146554



1000 Volt



1207

DIN ISO 5745

VDE Rundzangen

CPV = verchromt, Kopf poliert, Isoliergriffhüllen
IEC 900/DIN EN 60900/VDE 0682 Teil 201, mit langen Backen

VDE Long round nose plier

CPV = chromium plated, polished head, VDE insulated handles,
IEC 900/DIN EN 60900/VDE 0682 part 201, with long jaws

VDE Pincès à becs plats

CPV = chromées, tête polie, branches gaines isolées
IEC 900/DIN EN 60900/VDE 0682 paragraphe 201, avec becs longs

VDE Alicates boca redonda larga

CPV = cromado, cabeza pulida espejo, fundas aislantes
según IEC 900/DIN EN 60900/VDE 0682 apartado 201, bocas largas



Code	←L→				EAN
	mm	"			
01207016088	160	6.1/4	135	1	146578



1000 Volt

1208

DIN ISO 5745

VDE Flachrundzangen, gerade

CPV = verchromt, Kopf poliert, Isoliergriffhüllen
IEC 900/DIN EN 60900/VDE 0682 Teil 201, mit zusätzlich induktiv
gehärteten Schneiden, mit langen Backen und gezahnten Greifflächen,
mit gezahnter Aussparung, für mittelharten Draht

VDE Snipe nose pliers, straight

CPV = chromium plated, polished head, VDE insulated handles,
IEC 900/DIN EN 60900/VDE 0682 part 201, with cutting edges
additionally induction hardened, with long serrated jaws, with serrated
pipe grip



VDE Pincès à becs demi-ronds, droits

CPV = chromées, tête polie, branches gaines isolées,
IEC 900/DIN EN 60900/VDE 0682 paragraphe 201, avec trempage
complimentaire des tranchants par induction, avec becs longs et
surfaces de prise striées, avec serre-tube, pour fil de dureté moyenne

VDE Alicates boca semirredonda, recta

CPV = cromado, cabeza pulida espejo, fundas aislantes según
IEC 900/DIN EN 60900/VDE 0682 apartado 201, cortantes
templados por inducción, para alambre semi-duro, bocas largas
con dentado



Code	←L→			Ø mm			EAN
	mm	"					
01208016088	160	6.1/4	1,6	140	1	146714	
01208020088	200	8	1,8	200	1	023572	



1000 Volt

1209

DIN ISO 5745

VDE Flachrundzange, 45° abgewinkelt

CPV = verchromt, Kopf poliert, Isoliergriffhüllen
IEC 900/DIN EN 60900/VDE 0682 Teil 201 mit zusätzlich induktiv
gehärteten Schneiden, mit langen Backen und gezahnten Greifflächen,
mit gezahnter Aussparung, für mittelharten Draht

VDE Snipe nose plier, 45° angle

CPV = chromium plated, polished head, VDE insulated handles,
IEC 900/DIN EN 60900/VDE 0682 part 201, with cutting edges
additionally induction hardened, with long serrated jaws,
with serrated pipe grip



VDE Pincès à becs demi-ronds, coudés à 45°

CPV = chromées, tête polie, branches gaines isolées
IEC 900/DIN EN 60900/VDE 0682 paragraphe 201, avec trempage
complimentaire des tranchants par induction, avec becs longs et
surfaces de prise striées, avec serre-tube, pour fil de dureté moyenne

VDE Alicates boca semirredonda, curva a 45° cortante

CPV = cromado, cabeza pulida espejo, fundas aislantes
según IEC 900/DIN EN 60900/VDE 0682 apartado 201, cortantes
templados por inducción, para alambre semi-duro, bocas largas
con dentado



Code	←L→			Ø mm			EAN
	mm	"					
01209020088	200	8	1,8	200	1	023626	



1000 Volt

1213

DIN ISO 5749

VDE Seitenschneider, schwedische Form

CPV = verchromt, Kopf poliert, Isoliergriffhüllen
IEC 900/DIN EN 60900/VDE 0682 Teil 201,
Schneiden zusätzlich induktiv gehärtet, für mittelharten Draht

VDE Diagonal cutting nippers, swedish pattern

CPV = chromium plated, polished head, VDE insulated handles,
IEC 900/DIN EN 60900/VDE 0682 part 201,
Cutting edges additionally induction hardened, for middlehard wire

VDE Pincès coupantes diagonales, modèle suédois

CPV = chromées, tête polie, branches gaines isolées
IEC 900/DIN EN 60900/VDE 0682 paragraphe 201,
avec trempage complémentaire des franchants par induction, pour fil dur

VDE Alicates cortalambres, corte diagonal, modelo sueco

CPV = cromado, cabeza pulida espejo, fundas aislantes
según IEC 900/DIN EN 60900/VDE 0682 apartado 201,
cortantes templados por inducción, para alambre semi-duro



Code	←L→		Ø mm	g	EAN
	mm	"			
01213014088	140	5.1/2	1,8	155	146615
01213016088	160	6.1/4	2,0	215	146608
01213018088	180	7	2,5	280	146592



1000 Volt

1220

VDE Abisolierzange

CPV = verchromt, Kopf poliert, Isoliergriffhüllen,
IEC 900/DIN EN 60900/VDE 0682 Teil 201,
mit Stellschraube und Öffnungsfeder

VDE Wire stripping plier

CPV = chromium plated, polished head, VDE insulated handles,
IEC 900/DIN EN 60900/VDE 0682 part 201,
with adjusting screw and spring

VDE Pincès à dénuder

CPV = chromées, tête polie, branches gaines isolées
IEC 900/DIN EN 60900/VDE 0682 paragraphe 201
avec vis de réglage de butée et ressort d'ouverture

VDE Alicates pelacables

CPV = cromado, cabeza pulida espejo, fundas aislantes
según IEC 900/DIN EN 60900/VDE 0682 apartado 201
con tornillo de ajuste y muelle de apertura



Code	←L→		Ø mm	g	EAN
	mm	"			
01220016088	160	6.1/4	1,1 – 4,8	185	024098



1000 Volt

49-5

VDE-Elektriker Werkzeug-Garnitur

Modern das Design, klein der Raum, groß der Inhalt.
Die kompakt und modern gestaltete Box aus Polypropylen ist stoßunempfindlich, schlagfest, temperatur-, öl-, säure- und benzinbeständig.
Inhalt nach IEC 900/DIN EN 60900/VDE 0682 Teil 201.
Kunststoffbox 370 x 270 x 56 mm.

VDE Electricians tool-set

Modern in design, space-saving, with a large assortment of first class quality tools.
The compact and modern styled box, which is manufactured from polypropylene is shock-proof, resistant to impact, temperature, oil, acid and petrol.
Contents with IEC 900/DIN EN 60900/VDE 0682 part 201 certification.
Plastic box 370 x 270 x 56 mm.

VDE Composition d'outils VDE pour électricien







Moderne par son design, modeste par son encombrement, large et complet, par sa composition.
Ce coffret compact et moderne, en polypropylène, est insensible aux chocs, résistant aux variations de température, aux huiles, aux acides et à l'essence. Contenu conforme aux tests EN.
Coffret en matière plastique 370 x 270 x 56 mm.

Conjunto de herramientas para electricista VDE

Diseno moderno, volumen reducido, contenido amplio.
El maletin com-pacto y moderno resisto golpes, calor, aceite, ácido y gasolina.
Contenido según norma IEC 900/DIN EN 60900/VDE 0682 apartado 201. Maletin de plástico 370 x 270 x 56 mm.

Code	tlg. pcs.	Maße dimensions			EAN
00049000500	9	370 x 270 x 56 mm	1520	1	002188

enthaltend/containing

Stck. pcs.	Artikel/article	No.	Maße/dimensions
1		1208 VDE CPV	160 mm
1		1213 VDE CPV	140 mm
1		1220 VDE CPV	160 mm
2		1411 VDE BV	PH No. 1 2
1		1427 VDE ST	65 x 3 mm
3		1436 VDE BV	75 x 2,5 100 x 4 125 x 5,5 mm



1054-14

Elektriker Rucksack mit VDE-Werkzeugsortiment, 13-tlg.

Maße 440 x 360 x 170 mm. Hochwertiger Rucksack mit 32 innenliegenden und 4 außenliegenden Einsteckfächern, einem Laptopfach (bis 13,3"), sowie 16 Gummischlaufen für Werkzeuge aller Art.

Electrician's backpack with VDE tool assortment, 13 pcs.

Dimensions 440 x 360 x 170 mm. High-quality backpack with 32 pockets, a laptop compartment (up to 13.3"), 4 external storage compartments and 16 rubber loops for tools of all kinds.



Sac à dos d'électricien avec assortiment d'outils VDE, 13 pcs.









Dimensions 440 x 360 x 170 mm. Sac à dos de haute qualité avec 32 poches intérieures et 4 poches extérieures, un compartiment pour ordinateur portable (jusqu'à 13,3") et 16 boucles en caoutchouc pour toutes sortes d'outils.

Mochila de electricista con juego de herramientas VDE, 13 pzs.

Dimensiones 440 x 360 x 170 mm. Mochila de alta calidad con 32 bolsillos, un compartimento para portátil (hasta 13,3"), 4 compartimentos de almacenamiento externos y 16 trabillas de goma para herramientas de todo tipo.

NEU
NEW

Code	tlg./pcs.			EAN
01054001400	13	3005	1	460032

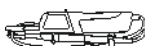
enthaltend/containing			
Stck. pcs.	Artikel/article	No.	Maße/size
1		1208 VDE CPV	200 mm
1		1200 VDE CPV	180 mm
1		1213 VDE CPV	160 mm
1		1220 VDE CPV	160 mm
2		4511 VDE BV	PH No. 1 / 2
4		4536 VDE BV	75 x 2,5 100 x 4 125 x 5,5 150 x 6,5 mm
1		1427 VDE	60 x 3 150-250 V
1		1920	10 mm
1		1426 VDE	6-1000 V



1230

Bremsfederzange

Chrom-Vanadium, N = vernickelt, speziell für aufgenietete Bremsbeläge



Brake spring plier

Chrome-Vanadium, N = nickel plated, particularly for riveted brake linings

Pinces à ressorts de freins

Chrom-Vanadium, N = nickelées, spéciales pour garnitures de freins rivetées

Tenazas para muelles de frenos

Cromo Vanadio, N = niquelado, especial para ferodos remachados



Code	mm	←L→	"			EAN
01230021550	215		8.1/2	242	1	024159

1232

Spannzange für Achsmanschetten und Schlauchklemmen

zum Verklemmen von Spannbändern für Achsmanschetten und Schläuche, passend für Stahl und Edelstahlschellen, Gewichtsoptimiert durch hochfestes Luftfahrtaluminium, gehärtete Spannbacken, einfaches Einstellen des vorgeschriebenen Drehmoments über den 3/8"-Antrieb mit Hilfe eines Drehmomentschlüssels,

Tongs for axle collars and hose clamps

for clamping of fastener straps of axle collars and hoses, suitable for steel- and stainless steel-clamps, optimized weight through high-tensile aircraft aluminium, hardened clamping jaws, simple setting of the required torque through the 3/8"-drive by means of torque wrench

Pince pour durites et colliers de serrage de l'axe de transmission

pour fixer les colliers de serrage, les axes et les flexibles, appropriés pour les colliers de serrage en acier et inox, Réduction du poids grâce à l'aluminium aéronautique à haute résistance, mâchoires trempées Réglage facile du couple de serrage conseillé au moyen du carré d'entraînement de 3/8"

Pinzas tensoras para manguitos axiales y presillas para tubos flexibles

para aprisionar cintas de sujeción para los manguitos axiales y tubos flexibles, adecuadas para abrazaderas de acero y acero inoxidable, Optimizadas en peso gracias al aluminio aeronáutico de alta resistencia, mordaza tensora endurecida, Ajuste sencillo del par prescrito gracias a la transmisión 3/8" con ayuda de una llave dinamoétrica de par



Code	mm	←L→	"	Nm			EAN
01232027500	280		11	max. 30	596	1	374667



max. Öffnungsweite: 45 mm
max. opening width: 45 mm

Griff aus leicht abwaschbarem Kunststoff.
Handle made of easily washable plastic.

1233

Auswuchtgewichtzange

Chrom-Vanadium, C = verchromt, zum Befestigen, Lösen, Verschieben und Zuschneiden von Auswuchtgewichten, zum Anpassen der Haltefedern

Balancing weight plier

Chrome-Vanadium, C = chromium plated, for fixing, loosening, shifting and cutting of balancing weights, for adjusting the clamping springs

Pince pour plombs d'équilibrage de roues

Chrom-Vanadium, C = chromées, pour monter, desserrer, déplacer et couper, des masses d'équilibrage aux pinces à ressort

Tenaza para pesos de compensación

Cromo Vanadio, C = cromado, para fijar, aflojar, desplazar y recortar pesos de compensación, para ajustar los muelles de sujeción



Code	mm	←L→	"			EAN
01233025080	260		10.1/4	419	1	375671

1250

DIN 5254 A

Zangen für Sicherungsringe, gerade

Chrom-Vanadium, ASD = schwarz, Gelenk geschliffen, Griffe kunststoffbeschichtet, CPD = verchromt, Gelenk poliert, Griffe kunststoffbeschichtet, mit geraden Backen, Spitzen schwarz, für Außen-Sicherungsringe (Wellen) nach DIN 471 + 983

Circlip pliers, straight

Chrome-Vanadium, ASD = black, joint area polished, plastic coated handles, CPD = chromium plated, joint area polished, plastic coated handles, with straight jaws, black points, for external circlips (shafts) to DIN 471 + 983

Pinces pour circlips, droites

Chrome-Vanadium, ASD = bruni, articulation meulée, branches gainées plastique, CPD = chromées, articulation polie, branches gainées plastique, à bords droits, pointes brunies, pour circlips extérieurs selon DIN 471 + 983

Tenaza para pesos de compensación

Cromo Vanadio, ASD = fosfatados, unión amolada, mangos plastificados, CPD = cromados, unión pulida, mangos plastificados bocas rectas, puntas negras, para arandelas exteriores según DIN 471 + 983

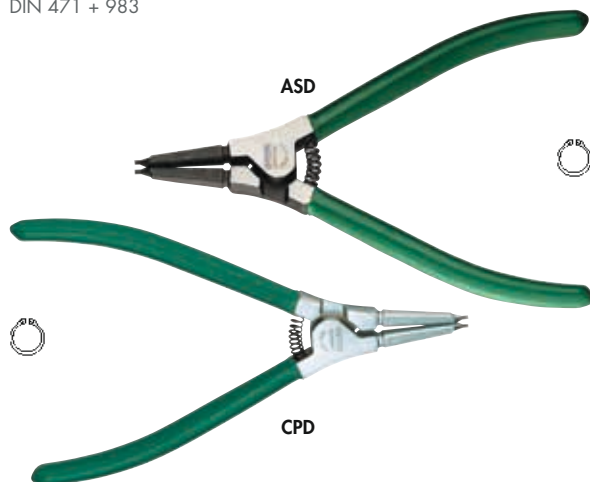

Code	Ausf. finish	Größe size	←L→		für for	mm	g	EAN
			mm	"				
01250114013	ASD	A3	140	5.1/2	3 – 10	90	1	147094
01250214013	ASD	A10	140	5.1/2	10 – 25	90	1	147087
01250017513	ASD	A19	175	7	19 – 60	175	1	147070
01250022013	ASD	A40	220	8.3/4	40 – 100	260	1	147063
01250030013	ASD	A85	300	11.3/4	85 – 140	490	1	147056
01250214087	CPD	A10	140	5.1/2	10 – 25	90	1	147131
01250017587	CPD	A19	175	7	19 – 60	175	1	147124
01250022087	CPD	A40	220	8.3/4	40 – 100	260	1	147117
01250030087	CPD	A85	300	11.3/4	85 – 140	490	1	147100

1252

DIN 5254 B

Zangen für Sicherungsringe, gewinkelt

Chrom-Vanadium, ASD = schwarz, Gelenk geschliffen, Griffe kunststoffbeschichtet, CPD = verchromt, Gelenk poliert, Griffe kunststoffbeschichtet, mit gewinkelten Backen, Spitzen schwarz, für Außen-Sicherungsringe (Wellen) nach DIN 471 + 983

Circlip pliers, bent

Chrome-Vanadium, ASD = black, joint area polished, plastic coated handles, CPD = chromium plated, joint area polished, plastic coated handles, with bent jaws, black points, for external circlips (shafts) to DIN 471 + 983

Pinces pour circlips, coudées

Chrome-Vanadium, ASD = bruni, articulation meulée, branches gainées plastique, CPD = chromées, articulation polie, branches gainées plastique, à bords coudés, pointes brunies, pour circlips extérieurs selon DIN 471 + 983

Alicates para arandelas, curvos

Cromo-Vanadio, ASD = fosfatados, unión amolada, mangos plastificados, CPD = cromados, unión pulida, mangos plastificados bocas curvas, puntas negras, para arandelas exteriores según DIN 471 + 983

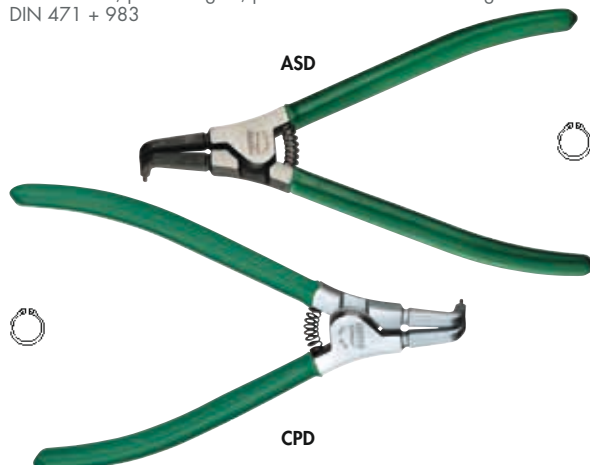

Code	Ausf. finish	Größe size	←L→		für for	mm	g	EAN
			mm	"				
01252113013	ASD	B3	130	5.1/4	3 – 10	90	1	147223
01252213013	ASD	B10	130	5.1/4	10 – 25	90	1	147216
01252016513	ASD	B19	165	6.1/2	19 – 60	175	1	147209
01252020513	ASD	B40	205	8	40 – 100	260	1	147193
01252027513	ASD	B85	275	10.3/4	85 – 140	490	1	147186
01252213087	CPD	B10	130	5.1/4	10 – 25	90	1	147179
01252016587	CPD	B19	165	6.1/2	19 – 60	175	1	147162
01252020587	CPD	B40	205	8	40 – 100	260	1	147155
01252027587	CPD	B85	275	10.3/4	85 – 140	490	1	147148

1255

DIN 5256 C

Zangen für Sicherungsringe, gerade

Chrom-Vanadium, ASD = schwarz, Gelenk geschliffen, Griffe kunststoffbeschichtet, CPD = verchromt, Gelenk poliert, Griffe kunststoffbeschichtet, mit geraden Backen, Spitzen schwarz, für Innen-Sicherungsringe (Bohrungen) nach DIN 472 + 984

Circlip pliers, straight

Chrome-Vanadium, ASD = black, joint area polished, plastic coated handles, CPD = chromium plated, joint area polished, plastic coated handles, with straight jaws, black points for internal circlips (bore holes) to DIN 472 + 984

Pinces pour circlips, droites

Chrome-Vanadium, ASD = bruni, articulation meulée, branches gainées plastique, CPD = chromées, articulation polie, branches gainées plastique, à bords droits, pointes brunies pour circlips intérieurs selon DIN 472 + 984

Alicates para arandelas, rectos

Cromo-Vanadio, ASD = fosfatados, unión amolada, mangos plastificados, CPD = cromados, unión pulida, mangos plastificados bocas rectas, puntas negras, para arandelas interiores según DIN 472 + 984



ASD



CPD

Code	Ausf. finish	Größe size	←L→		für for	mm	g	EAN
			mm	"				
01255114513	ASD	C8	145	5.3/4	8 – 13	90	1	147353
01255214513	ASD	C12	145	5.3/4	12 – 25	90	1	147346
01255018013	ASD	C19	180	7	19 – 60	175	1	147339
01255023013	ASD	C40	230	9	40 – 100	260	1	147322
01255031013	ASD	C85	310	12.1/4	85 – 140	490	1	147315
01255214587	CPD	C12	145	5.3/4	12 – 25	90	1	147308
01255018087	CPD	C19	180	7	19 – 60	175	1	147292
01255023087	CPD	C40	230	9	40 – 100	260	1	147285
01255031087	CPD	C85	310	12.1/4	85 – 140	490	1	147278

1256

DIN 5256 D

Zangen für Sicherungsringe, gewinkelt

Chrom-Vanadium, ASD = schwarz, Gelenk geschliffen, Griffe kunststoffbeschichtet, CPD = verchromt, Gelenk poliert, Griffe kunststoffbeschichtet, mit gewinkelten Backen, Spitzen schwarz, für Innen-Sicherungsringe (Bohrungen) nach DIN 472 + 984

Circlip pliers, bent

Chrome-Vanadium, ASD = black, joint area polished, plastic coated handles, CPD = chromium plated, joint area polished, plastic coated handles, with bent jaws, black points for internal circlips (bore holes) to DIN 472 + 984

Pinces pour circlips, coudées

Chrome-Vanadium, ASD = bruni, articulation meulée, branches gainées plastique, CPD = chromées, articulation polie, branches gainées plastique, à bords coudés, pointes brunies, pour circlips intérieurs selon DIN 472 + 984

Alicates para arandelas, curvos

Cromo-Vanadio, ASD = fosfatados, unión amolada, mangos plastificados, CPD = cromados, unión pulida, mangos plastificados bocas curvas, puntas negras, para arandelas interiores según DIN 472 + 984

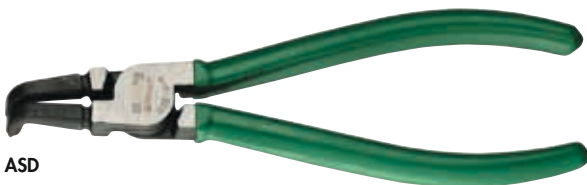

ASD

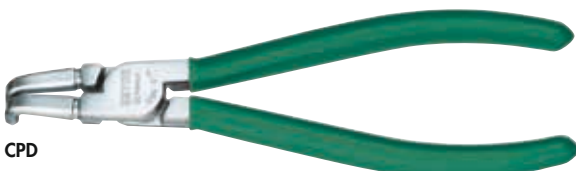

CPD

Code	Ausf. finish	Größe size	←L→		für for	mm	g	EAN
			mm	"				
01256113513	ASD	D8	135	5.1/4	8 – 13	90	1	147445
01256213513	ASD	D12	135	5.1/4	12 – 25	90	1	147438
01256017013	ASD	D19	170	6.3/4	19 – 60	175	1	147421
01256021513	ASD	D40	215	8.1/2	40 – 100	260	1	147414
01256029013	ASD	D85	290	11.1/2	85 – 140	490	1	147407
01256213587	CPD	D12	135	5.1/4	12 – 25	90	1	147391
01256017087	CPD	D19	170	6.3/4	19 – 60	175	1	147384
01256021587	CPD	D40	215	8.1/2	40 – 100	260	1	147377
01256029087	CPD	D85	290	11.1/2	85 – 140	490	1	147360

1258

Drahtwirbelzange mit Ratschenfunktion

Zum Verwirbeln und Schneiden von Sicherungsdrähten. Gleichmäßige Verwirbelung durch Ratschenfunktion. Rechts- und Linksrotation ermöglicht die Öffnung von verwirbelten Drähten ohne mechanische Beschädigung des Sicherungsdrahtes. Automatische Rückführung. Spezial gehärtete Backen, auch für dünne Edelstahldrähte geeignet.

Wire swivelling pliers with ratchet function

For swivelling and cutting of locking wires. Consistent swivelling through ratchet function. Clockwise and counterclockwise rotation allows opening of swivelled wires without damaging the locking wire. Automatic feedback. Special hardened jaws also suitable for stainless steel.

Pince de torsion à cliquet

Pour torser et couper le fil de verrouillage. Torsion constant grâce au cliquet. La rotation à gauche et à droite permet l'ouverture des fils tordu sans endommager le fil. Réroaction automatique. Mâchoires durcies qui conviennent aussi pour l'acier inoxydable.

Alicata para trenzado de alambre función de carraca

Para trenzar y cortar alambres de seguridad trenzado uniforme mediante la función de carraca. El giro a la derecha y a la izquierda posibilita el destrenzado de alambres trenzados sin daño mecánico del alambre de seguridad, retroceso automático, bocas especialmente templadas, aptas también para alambres inoxidables delgados.



1258-15



1258-22

Code	No.	←L→		g	g	EAN
		mm	"			
01258015000	1258-15	230	9	300	1	380101
01258022500	1258-22	290	11	400	1	380125



1261-30 - 1261-60

Gewindenietensatz in Blisterverpackung

Verpackungseinheit: 20 Stück. Gewindenieten aus Alu-Legierung.

Rivet nut set in blister packing

Packing unit: 20 pcs.. Rivet nuts made of aluminium alloy.

Ecrous aveugles sous blister

Emballage: 20 pièces. Ecrous aveugles en aluminium.

Set de remaches roscados en pack de plástico

En un pack: 20 unidades. Remaches roscados de aluminio aleado.



Code	No.	Maße/dimensions	g	g	EAN
01261400000	1261-40	M4 x 0,7	150	1	376098
01261500000	1261-50	M5 x 0,8	150	1	376104
01261600000	1261-60	M6 x 1,0	150	1	376111

1261-31 - 1261-61

Gewindedorn

Verpackungseinheit: 1 Stück

Threaded mandrel

Packing unit: 1 pcs.

Mandrin

Emballage: 1 pièce

Mandril roscado

En un pack: 1 unidad



Code	No.	Maße/dimensions	g	g	EAN
01261410000	1261-41	M4 x 0,7	25	1	376166
01261510000	1261-51	M5 x 0,8	25	1	376173
01261610000	1261-61	M6 x 1,0	25	1	376180

1261-32 - 1261-62

Gewindenietensatz in Karton

Verpackungseinheit: 500 Stück, Gewindenieten aus Alu-Legierung.

Rivet nut set in carton box

Packing unit: 500 pcs. Rivet nuts made of aluminium alloy.

Ecrous aveugles en carton

Emballage: 500 pièces. Ecrous aveugles en aluminium.

Set de remaches roscados en pack de cartón

En un pack: 500 unidades. Remaches roscados de aluminio aleado.



Code	No.	Maße/dimensions			EAN
01261300200	1261-32	M3 x 0,5	350	1	376067
01261400200	1261-42	M4 x 0,7	350	1	376128
01261500200	1261-52	M5 x 0,8	350	1	376135
01261600200	1261-62	M6 x 1,0	350	1	376142

1261-1

Gewindenietenzangensatz in Metallkasten

Hand rivet nut tool kit in metal case

Pince à écrous aveugles en boîtier métallique

Set de tenazas para remaches roscados en caja metálica



Code	No.	mm	$\leftarrow L \rightarrow$	"			EAN
01261000100	1261-1	250		10	2511	1	376609

enthaltend/containing

Code	Artikel	article
01261025000	Gewindenietenzange	hand rivet nut tool
01261001000	Gewindenietensatz in Kunststoffbox	rivet nut set in plastic box
01261310000	Gewindedorn M3 x 0,5	threaded mandrel M3 x 0,5
01261410000	Gewindedorn M4 x 0,7	threaded mandrel M4 x 0,7
01261510000	Gewindedorn M5 x 0,8	threaded mandrel M5 x 0,8
01261610000	Gewindedorn M6 x 1,0	threaded mandrel M6 x 1,0

1261

Gewindenietenzange, handbetätigt

ST = standardmäßig, Gehäuse aus Aludruckguß, mit stahl-geschmiedetem Betätigungshebel. 4 auswechselbare Mundstücke (M3, M4, M5, M6), selbstöffnend durch integrierte Feder, stufenlos verstellbarer Anschlag, ergonomischer Softgriff.

Hand rivet nut tool

ST = standard, Housing made of aluminium and die cast - steel forged actuating lever. 4 exchangeable nosepieces (M3, M4, M5, M6), continuously adjustable, ergonomic soft grip.

Pince à écrous aveugles manuel

ST = standard, Boîtier en aluminium moulé sous pression et levier en acier forgé. 4 embouts interchangeables (M3, M4, M5, M6), ouverture automatique par ressort intégré, butée réglable en continu, poignée ergonomique souple.

Tenaza para remaches roscados, manual

ST = estándar, Carcasa de aluminio fundido a presión y palanca de accionamiento de acero forjado. 4 boquillas intercambiables (M3, M4, M5, M6). Se abre automáticamente gracias a un muelle integrado. Tope ajustable en cualquier punto. Empuñadura blanda ergonómica.



Code	No.	mm	$\leftarrow L \rightarrow$	"			EAN
01261025000	1261	250		10	620	1	376555

1261-10

Gewindenietensatz in Kunststoffbox

Bestehend aus vier verschiedenen Gewindenieten. Gewindenieten aus Alu-Legierung.

Rivet nut set in plastic box

Consisting of four different rivet nuts. Rivet nuts made of aluminium alloy

Écrous aveugles en coffret plastique

Comprenant quatre différents écrous aveugles. Écrous aveugles en aluminium.

Set de remaches roscados en caja de plástico

Que consta de 4 remaches roscados diferentes. Remaches roscados de aluminio aleado.



Code	No.			EAN
01261001000	1261-10	150	1	376562

enthaltend/containing

Stck.	Maße/dimensions
50	M3 x 0,5
60	M4 x 0,7
60	M5 x 0,8
30	M6 x 1,0

1262-24-1 - 1262-48-1

Blindnietensatz in Blisterverpackung

Verpackungseinheit: 30 Stück. Blindnieten aus Alu-Legierung.

Blind rivet set in blister packing

Packing unit: 30 pcs.. Blind rivets made of aluminium alloy.

Rivets sous blister

Emballage: 30 pièces. Rivets en aluminium.

Set de remaches ciegos en pack de plástico

En un pack: 30 unidades. Remaches ciegos de aluminio aleado.

Code	No.	Maße/dimensions			EAN
01262240100	1262-24-1	2,4	150	1	376296
01262320100	1262-32-1	3,2	150	1	376289
01262400100	1262-40-1	4,0	150	1	376272
01262480100	1262-48-1	4,8	150	1	376265



1262-24-2 - 1262-48-2

Blindnietensatz in Karton

Verpackungseinheit: 500 Stück. Blindnieten aus Alu-Legierung.

Blind rivet set in carton box

Packing unit: 500 pcs.. Blind rivets made of aluminium alloy.

Rivets en carton

Emballage: 500 pièces. Rivets en aluminium.

Set de remaches ciegos en pack de cartón

En un pack: 500 unidades. Remaches ciegos de aluminio aleado.

Code	No.	Maße/dimensions			EAN
01262240200	1262-24-2	2,4	350	1	376258
01262320200	1262-32-2	3,2	350	1	376241
01262400200	1262-40-2	4,0	350	1	376234
01262480200	1262-48-2	4,8	350	1	376227



1280-N

Universal-Gripzangen

Chrom-Vanadium (Greifbacken), N = vernickelt mit halbrunden Backen, mit Drahtschneider

Universal grip pliers

Chrome-Vanadium (jaws), N = nickel plated with half-round jaws, with wire cutter

Pinces-étaux universelles

Chrom-Vanadium (mors), N = nickelées avec mors concaves, et coupe-fil

Tenazas grip universales

Cromo Vanadio (bocas), N = niquelado con bocas curvas, con cortante



Code	←L→		mm	g	EAN
	mm	"			
01280017550	175	7	35	353	1 024937
01280025050	250	10	50	534	1 024944
01280030050	300	12	65	900	1 024951

1280-L

Universal-Gripzangen

Chrom-Vanadium (Greifbacken) L = lackiert, mit halbrunden Backen Verbesserter Korrosionsschutz durch Spezialbeschichtung.

Universal grip pliers

Chrome-Vanadium (jaws), L = lacquered, with half-round jaws Improved corrosion protection through special coating.

Pinces-étaux universelles

Chrom-Vanadium (mors), N = nickelées, avec mors concaves Amélioration de la protection contre la corrosion grâce à un revêtement spécial.

Tenazas grip universales

Cromo Vanadio (bocas), L = barnizado, con bocas curvas Mejor protección contra la corrosión, gracias a su revestimiento especial.



Code	←L→		mm	g	EAN
	mm	"			
01280030020*	300	12	65	910	1 371574



1281

Universal-Gripzangen

Chrom-Vanadium (Greifbacken), N = vernickelt Universell einsetzbar durch spezielle Formgebung der Backen.

Universal grip pliers

Chrome-Vanadium (jaws), N = nickel plated V-shaped jaws permit universal application.

Pinces-étaux universelles

Chrom-Vanadium (mors), N = nickelées Mors forme «V» pour une application universelle.

Tenazas grip universales

Cromo Vanadio (bocas), N = niquelado De uso universal gracias al diseño especial de las bocas.



Code	←L→		mm	g	EAN
	mm	"			
01281017550	175	7	45	370	1 024968
01281025050	250	10	50	580	1 024982

1282

Universal-Gripzange

Chrom-Vanadium (Greifbacken), N = vernickelt, mit geraden Backen

Universal grip plier

Chrome-Vanadium (jaws), N = nickel plated, with straight jaws

Pinces-étaux universelles

Chrom-Vanadium (mors), N = nickelées, avec mors droits

Tenazas grip universales

Cromo Vanadio (bocas), N = niquelado, con bocas rectas



Code	←L→		mm	g	EAN
	mm	"			
01282025050	250	10	40	512	1 024999

1285

Schweiß-Gripzange

Chrom-Vanadium (Greifbacken), N = vernickelt, speziell für Profil- und Flachmaterial

Welding grip plier

Chrome-Vanadium (jaws), N = nickel plated, particularly for profiled and flat material



Pinces-étaux pour soudure

Chrome-Vanadium (mâchoires), N = nickelées, spéciales pour matériaux profilés et plats

Tenazas grip para soldadores

Chromo Vanadio (bocas), N = niquelado, horquilla para perfiles y material plano



Code	mm	↔	"				EAN
01285028050*	280		11	55	792	1	025026

1327

Bandschlüssel

Chrom-Vanadium (280 mm), ND = vernickelt, Griff PVC-überzogen, C = verchromt, mit rutschfestem Gummigewebeband, speziell für Ölfilter und sonstige empfindliche Verschraubungen

Strap wrenches

Chrome-Vanadium (280 mm), ND = nickel plated, plastic coated handle
C = chromium plated, with non-skid fabric rubber strap, particularly for oil filters and other sensitive screwed connections



Clés à sangle

Chrome-Vanadium (280 mm), ND = nickelées, branche gainée plastique
C = chromées, avec ruban engommé antidérapant, spéciale pour filtres à huile et autres vissages délicats

Llaves de correa

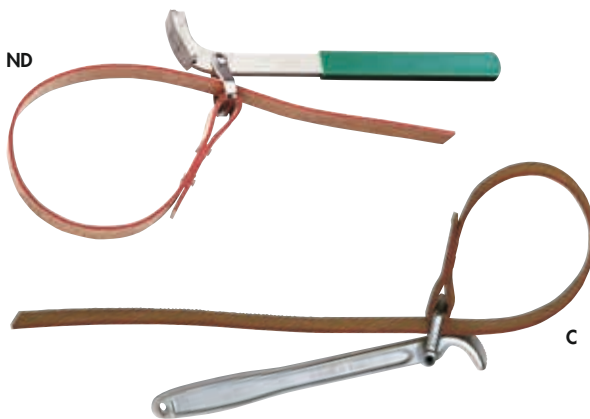
Chromo Vanadio (280 mm), ND = niquelado, mangos plastificados con PVC, C = cromado, con correa de tejido engomado de buena adherencia, especial para filtros de aceite y otros objetos delicados



Code	No.	Ausf. finsh	↔	mm	"	für Ø bis for Ø up to			EAN
01327023054	1327-1	ND	230	9	160	6.1/4	283	1	025644
01327028080	1327-2	C	280	11	240	9.1/2	504	1	025651

1328

Ersatzbänder für Bandschlüssel HEYCO 1327

ST = standardmäßig, aus 3-lagigem Gummigewebeband

Spare straps for strap wrenches HEYCO 1327



ST = standard, fabric rubber strap of 3 layers

Sangles de rechange pour clés à sangle HEYCO 1327

ST = standard, ruban engommé à trois couches

Correas de recambio para llaves de correa HEYCO 1327

ST = estándar, de tejido engomado de 3 capas

Code	No.	für/for	L x B			EAN
01328100000	1328-1	1327-1	615 x 22,5	57	10	025668
01328200000	1328-2	1327-2	810 x 25,0	90	10	025675

1329-3 1329-4

Ölfilterschlüssel

ND = vernickelt, Griff PVC-überzogen,
mit verstellbarem Stahlband, mit Hebelgriff

Oil filter wrenches

ND = nickel plated, plastic coated handle,
with adjustable steel tape, with levering handle

Clés pour filtres à huile

ND = nickelées, branche gainée plastique,
avec sangle métallique ajustable et manche de levier

Llaves para filtros de aceite

ND = niquelado, mangos plastificados con PVC,
con cinta de acero ajustable, con mango palanca

Code	No.	←L→		für/for Ø		g	EAN
		mm	"	mm	"		
01329000354	1329-3	205	8	60 – 80	2.3/8 – 3.1/8	280	1 025705
01329000454	1329-4	215	8.1/2	80 – 110	3.1/8 – 4.1/4	320	1 025712



1330

DIN 5234 B

Eck-Rohrzangen

Chrom-Vanadium, L = lackiert
Schwedisches Modell

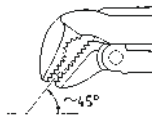

Elbow pipe wrenches

Chrome-Vanadium, L = lacquered
Swedish pattern

Serre-tubes

Chrome-Vanadium, L = laquées
Modèle suédois

Llaves para tubos

Cromo Vanadio, L = barnizado
Modelo sueco

Code	mm	←L→		für/for Ø	g	EAN
		mm	"			
01330001020	315		12.1/2	1	732	1 025729
01330001520	420		16.1/2	1.1/2	1490	1 025736
01330002020	535		22	2	2523	1 025743
01330003020	705		28	3	4067	1 025750



1333

DIN 5234 A

Rohrzangen

Chrom-Vanadium, L = lackiert
Schwedisches Modell

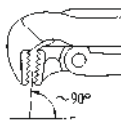

Pipe wrenches

Chrome-Vanadium, L = lacquered
Swedish pattern

Serre-tubes

Chrome-Vanadium, L = laquées
Modèle suédois

Llaves para tubos

Cromo Vanadio, L = barnizado
Modelo sueco

Code	mm	←L→		für/for Ø	g	EAN
		mm	"			
01333001020	315		12.1/2	1	787	1 025767
01333001520	420		16.1/2	1.1/2	1468	1 025774
01333002020	560		22	2	2544	1 025781
01333003020	685		27	3	4166	1 025798



SCHRAUBENDREHER

SCREWDRIVERS

170-177 Seite/page

Winkelschraubendreher
Hexagonal head wrenches
Clés mâles coudées
Llaves Allen

177-201 Seite/page

Schraubendreher
Screwdrivers
Tournevis
Destornilladores





1335

Kugelpf-Winkelschraubendreher für Innensechskantschrauben

Chrom-Vanadium, C = verchromt (mit schwarzer Spitze) mit schlagfestem Kunststoffheft, zum Schrauben von schwer zugänglich liegenden Innensechskantschrauben in einem Arbeitswinkel von bis zu 20°.

Ball head hexagonal wrenches for hexagon socket screws

Chrome-Vanadium, C = chromium plated (with black tip) with shockproof plastic handle, spherical head permits usage on hexagon socket, screws located in confined or hard to reach areas off-axis operation up to 20°.

Clés mâles coudées emmanchées à tête sphérique pour vis 6 pans creux

Chrom-Vanadium, C = chromées (extrémité noire) manche en matière plastique incassable, grâce à leur tête sphérique, ces clés permettent, d'intervenir sur des vis 6 pans creux peu accessibles dont l'inclinaison va jusqu'à 20°.

Cabeza esférica Juegos de llaves Allen, acodadas para tornillos Allen

Cromo Vanadio, C = cromado (con punta negra) mango de plástico antichoque, para el atornillado de tornillos en sitios de difícil acceso ángulo de trabajo, de hasta 20°.

Code	MM	L ₁ mm	L ₂ mm	g		EAN
01335002580	2,5	125	15	14	10	113174
01335003080	3,0	125	15	17	10	113167
01335004080	4,0	125	15	26	10	113150
01335005080	5,0	150	20	53	10	113143
01335006080	6,0	150	20	59	10	113136
01335008080	8,0	175	25	150	10	113129
01335010080	10,0	200	25	230	10	113112

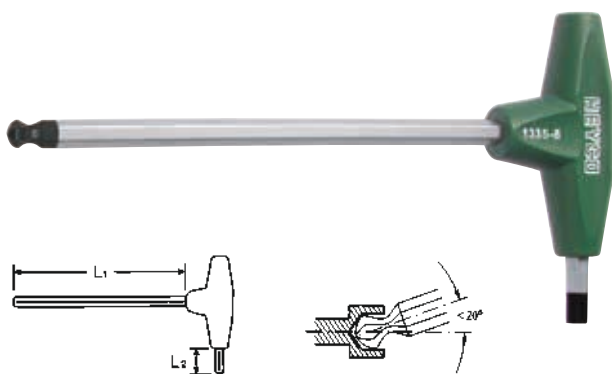

R 1335-6

Winkelschraubendreher-Satz für Innensechskantschrauben in Kunststofftasche

Hexagonal head wrench set for hexagon socket screws in plastic wallets

Jeux de clés mâles coudées pour vis 6 pans creux en trousse plastique

Juegos de llaves Allen, acodadas para tornillos Allen en bolsas, de plástico

Code	tlg./pcs.	g		EAN
01335727280	6	420	1	347296

enthaltend/containing
MM 2,5 3 4 5 6 8



1337

Winkelschraubendreher für Innensechskantschrauben

Chrom-Vanadium, C = verchromt
(mit schwarzer Spitze) mit schlagfestem Kunststoffheft

Hexagonal head wrenches for hexagon socket screws

Chrome-Vanadium, C = chromium plated
(with black tip) with shockproof plastic handle

Clés mâles coudées pour vis 6 pans creux

Chrome-Vanadium, C = chromées
(extrémité noire) avec manche en matière plastique incassable

Llaves Allen, acodadas para tornillos Allen

Cromo Vanadio, C = cromado
(con punta negra) mango de plástico antichoque

Code	MM	L ₁ mm	L ₂ mm	g		EAN
01337002580	2,5	125	15	14	10	100242
01337003080	3,0	125	15	17	10	100259
01337003580	3,5	125	15	21	10	100266
01337004080	4,0	125	15	26	10	100273
01337004580	4,5	150	20	45	10	100280
01337005080	5,0	150	20	53	10	100297
01337006080	6,0	150	20	69	10	100303
01337007080	7,0	175	25	125	10	100310
01337008080	8,0	175	25	150	10	100327
01337010080	10,0	200	25	230	10	100334

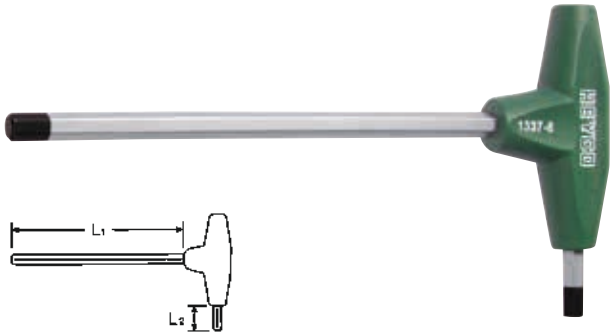

R 1337-6

Winkelschraubendreher-Satz für Innensechskantschrauben

in Kunststofftasche

Hexagonal head wrench set for hexagon socket screws

in plastic wallets

Jeux de clés mâles coudées pour vis 6 pans creux

en trousse plastique

Juegos de llaves Allen, acodadas para tornillos Allen

en bolsas, de plástico

Code	tlg./pcs.	g		EAN
01337722080	6	452	1	110722

enthaltend/containing
MM 2,5 3 4 5 6 8



1340

DIN/ISO 2936

Winkelschraubendreher für Innensechskantschrauben

Chrom-Vanadium
B = brüniert

Hexagonal head wrenches for hexagon socket screws

Chrome-Vanadium
B = burnished

Clés mâles coudées pour vis 6 pans creux

Chrome-Vanadium
B = bruniés

Llaves Allen, acodadas para tornillos Allen

Cromo Vanadio
B = pavonado



Code	MM	mm	g		EAN
01340001030	1	45 x 10	1	10	025873
01340001530	1,5	45 x 14	1	10	025880
01340002030	2	50 x 16	2	10	025903
01340002530	2,5	56 x 18	3	10	025927
01340003030	3	63 x 20	5	10	025941
01340003530	3,5	68 x 22	7	10	025965
01340004030	4	70 x 25	10	10	025989
01340004530	4,5	75 x 27	14	10	026016
01340005030	5	80 x 28	19	10	026030
01340006030	6	90 x 32	29	10	026061
01340007030	7	95 x 34	42	10	026092
01340008030	8	100 x 36	60	10	026122
01340009030	9	105 x 38	80	10	026153
01340010030	10	112 x 40	105	10	026177
01340012030	12	125 x 45	165	10	026207
01340013030	13	132 x 50	210	10	026238
01340014030	14	140 x 56	255	5	026252
01340017030	17	160 x 63	440	5	026283
01340019030	19	180 x 70	615	5	026313
01340022030	22	200 x 80	935	5	026337
01340024030	24	224 x 90	1250	1	026351
01340027030	27	250 x 100	1770	1	026375
01340030030	30	280 x 112	2460	1	026399
01340032030	32	315 x 125	3140	1	026412
01340036030	36	355 x 140	4400	1	026436

Code	AF	mm	g		EAN
01340630130	3/64	44 x 14	1	10	026511
01340630230	1/16	45 x 15	1	10	026535
01340630330	5/64	48 x 16	2	10	026559
01340630430	3/32	51 x 17	3	10	026573
01340630530	1/8	57 x 22	6	10	026580
01340630730	5/32	65 x 25	10	10	026603
01340630830	3/16	70 x 29	15	10	026627
01340631030	7/32	80 x 32	23	10	026641
01340631230	1/4	87 x 32	32	10	026665
01340631430	9/32	95 x 35	45	10	026689
01340631630	5/16	98 x 40	58	10	026702
01340631930	3/8	110 x 45	96	10	026726
01340632130	7/16	124 x 48	145	10	026740
01340632330	1/2	133 x 50	195	10	026764
01340632530	9/16	152 x 57	285	5	026788
01340632730	5/8	160 x 59	375	5	026801
01340633130	3/4	178 x 70	615	5	026825

H 1340

Winkelschraubendreher-Sätze für Innensechskantschrauben in Handklapphaltern, (Halter vernickelt)

Hexagonal head wrench sets for hexagon socket screws in metal holders, (holder nickel plated)

Jeux de clés mâles coudées pour vis 6 pans creux sur monture, (monture nickelée)

Juegos de llaves Allen, acodadas para tornillos Allen en monturas niqueladas



Code	No.	MM	= 5			g	EAN
01340622030	H 1340-6-M	2,5	3	4	5	240	026498
		6	8				
01340623030	H 1340-7-M	2,5	3	4	5	370	026504
		6	8	10			

Code	No.	AF	= 5			g	EAN
01340637030	H 1340-5-AF	5/32	3/16	7/32	1/4	255	026849
		5/16					
01340638030	H 1340-6-AF	5/64	3/32	1/8	5/32	165	026856
		3/16	7/32				

HP 1340-9

Winkelschraubendreher-Satz für Innensechskantschrauben
in Kunststoffhaltern

Hexagonal head wrench set for hexagon socket screws
in plastic holders

Jeux de clés mâles coudées pour vis 6 pans creux
sur monture plastique

Juegos de llaves Allen, acodadas para tornillos Allen
sobre soporte-expositor de plástico



Code	tlg./pcs.	g		EAN
01340825030	9	250	1	099720
enthaltend/containing				
MM 1,5 2 2,5 3 4 5 6 8 10				

K 1340

Winkelschraubendreher-Sätze für Innensechskantschrauben
auf Ringen

Hexagonal head wrench sets for hexagon socket screws
on rings

Jeux de clés mâles coudées pour vis 6 pans creux
sur anneau

Juegos de llaves Allen, acodadas para tornillos Allen
en anillos



Code	No.	MM	= 5	g	EAN
01340524030	K 1340-8-M	2 2,5 3 4	= 5	245	026474
		5 6 8 10			
Code	No.	AF	= 5	g	EAN
01340534030	K 1340-8-AF	1/16 5/64 3/32 1/8	= 5	100	026481
		5/32 3/16 7/32 1/4			

R 1340

Winkelschraubendreher-Sätze für Innensechskantschrauben
in Rolltaschen, Kunststoff, mit Band

Hexagonal head wrench sets for hexagon socket screws
in plastic wallets, with strap

Jeux de clés mâles coudées pour vis 6 pans creux
en trousse plastique, avec lanière

Juegos de llaves Allen, acodadas para tornillos Allen
en bolsas enrollables, de plástico, con correa



Code	No.	MM	= 1	g	EAN
01340725530	R 1340-10-M	2 2,5 3 4 5 6 7	= 1	410	026863
		8 9 10			
01340727030	R 1340-12-M	2 2,5 3 3,5 4 5 6	= 1	580	026870
		7 8 9 10 12			
Code	No.	AF	= 1	g	EAN
01340735530	R 1340-10-AF	1/16 5/64 3/32 1/8	= 1	300	026894
		5/32 3/16 7/32 1/4			
		5/16 3/8			
01340737030	R 1340-12-AF	1/16 5/64 3/32 1/8	= 1	645	026900
		5/32 3/16 7/32 1/4			
		5/16 3/8 7/16 1/2			

1341

DIN/ISO 2936

Winkelschraubendreher, lang, für Innensechskantschrauben

Chrom-Vanadium, B = brüniert

Hexagonal head wrenches, long series, for hexagon socket screws

Chrome-Vanadium, B = burnished

Clés mâles coudées, série longue pour vis 6 pans creux

Chrome-Vanadium, B = brunies

Llaves Allen, acodadas, serie larga para tornillos Allen

Cromo Vanadio, B = pavonado



Code	MM	mm	g		EAN
01341002030	2	100 x 16	3	10	027051
01341002530	2,5	112 x 18	6	10	027068
01341003030	3	126 x 20	9	10	027075
01341004030	4	140 x 25	18	10	027082
01341005030	5	160 x 28	31	10	027099
01341006030	6	180 x 32	50	10	027105
01341007030	7	190 x 34	74	10	027112
01341008030	8	200 x 36	105	10	027129
01341009030	9	210 x 38	135	10	027136
01341010030	10	224 x 40	180	10	027143
01341012030	12	250 x 45	290	10	027150
01341014030	14	280 x 56	450	5	027167
01341017030	17	320 x 63	750	5	027174
01341019030	19	360 x 70	1050	5	027181

HP 1343-9

Kugelpf-Winkelschraubendreher-Satz

Chrom-Vanadium, B = brüniert, in Kunststoffhaltern

Zum Schrauben von schwer zugänglich liegenden Innensechskantschrauben in einem Arbeitswinkel von bis zu 20°.

Ball head hexagonal wrench set

Chrome-Vanadium, B = burnished, in plastic holders

Spherical head permits usage on hexagon socket screws located in confined, or hard to reach areas, off-axis operation up to 20°.

Jeux de clés mâles coudées emmanchées à tête sphérique

Chrome-Vanadium, B = brunies, en monture plastiques

Grâce à leur tête sphérique, ces clés permettent d'intervenir sur des vis 6 pans creux, peu accessibles dont l'inclinaison va jusqu'à 20°.

Cabeza esférica Juegos de llaves Allen, acodadas

Cromo Vanadio, B = pavonado, sobre soporte-expositor de plástico

Para el atornillado de tornillos en sitios de difícil acceso ángulo de trabajo de hasta 20°.

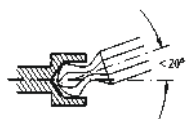
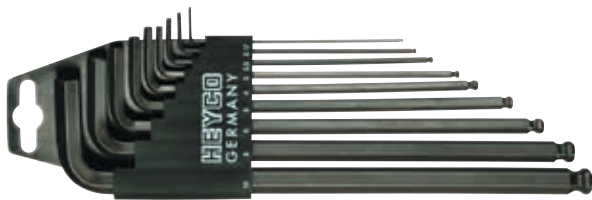

Code	tlg./pcs.	g		EAN
01343825030	9	405	1	099768

enthaltend/containing

MM 1,5 2 2,5 3 4 5 6 8 10

1345

Winkelschraubendreher für Innenvielzahn-Schrauben XZN

Chrom-Vanadium, B = brüniert

Multi-spline wrenches, "L"-shaped for multi-spline socket screws XZN

Chrome-Vanadium, B = burnished

Clés mâles coudées pour vis denture multiple XZN

Chrome-Vanadium, B = brunies

Llaves macho, acodadas, con dentado para tornillos XZN

Cromo Vanadio, B = pavonado



Code	für Schrauben for screws	mm	g		EAN
01345000530	M 5	75 x 25	15	10	027303
01345000630	M 6	80 x 28	25	10	027310
01345000830	M 8	90 x 32	43	10	027327
01345001030	M 10	100 x 36	82	10	027334
01345001230	M 12	112 x 40	125	10	027341
01345001430	M 14	125 x 45	190	5	027358
01345001630	M 16	140 x 55	305	5	027365

R 1345-7

Winkelschraubendreher-Satz für Innenvielzahn-Schrauben XZN
in Kunststofftasche

Multi-spline wrench set, "L"-shaped for multi-spline socket screws XZN
in plastic wallet

Jeux de clés mâles coudées pour vis denture multiple XZN
en trousse plastique

Juegos de llaves macho, acodadas, con dentado para tornillos XZN
en bolsas de plástico



Code	für Schrauben for screws	g		EAN
01345723030	M 5 6 8 10 12 14 16	850	1	027396

1347

Winkelschraubendreher für Innen-TORX®-Schrauben
Chrom-Vanadium, C = verchromt, (mit schwarzer Spitze)
mit schlagfestem Kunststoffheft

TORX®-Wrenches, "L"-shaped for TORX®-Socket screws
Chrome-Vanadium, C = chromium plated, (with black tip)
with shockproof plastic handle

Clés mâles coudées pour vis TORX® intérieures
Chrome-Vanadium, C = chromées, (extrémité noire)
manche en matière plastique incassable

Llaves macho, acodadas para tornillos TORX® interiores
Cromo Vanadio, C = cromado, (con punta negra)
mango de plástico antichoque

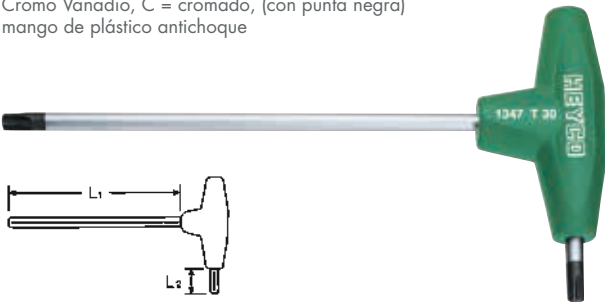

Code	Größe size	mm	L ₁ mm	L ₂ mm	g		EAN
01347000680	T 6	1,67	125	15	16	10	110333
01347000780	T 7	1,99	125	15	16	10	110340
01347000880	T 8	2,31	125	15	16	10	110357
01347000980	T 9	2,50	125	15	17	10	110364
01347001080	T 10	2,74	125	15	18	10	110371
01347001580	T 15	3,27	125	15	20	10	110388
01347002080	T 20	3,86	125	15	24	10	110395
01347002580	T 25	4,43	150	20	43	10	110401
01347002780	T 27	4,99	150	20	56	10	110418
01347003080	T 30	5,52	150	20	63	10	110425
01347004080	T 40	6,65	175	25	113	10	110432

R 1347-6

Winkelschraubendreher-Satz für Innen-TORX®-Schrauben
in Kunststofftaschen

Hexagonal head wrench set for TORX®-Socket screws
in plastic wallets

Jeux de clés mâles coudées pour vis TORX® intérieures
en trousse plastique

Juegos de llaves Allen, acodadas para tornillos TORX® interiores
en bolsas, de plástico



Code	tlg./pcs.	g		EAN
0134722080	6	397	1	347302

enthaltend/containing
T10 T15 T20 T25 T30 T40

1348

Winkelschraubendreher für Innen-TORX®-Schrauben

Chrom-Vanadium, B = brüniert

TORX®-Wrenches, "L"-shaped for TORX®-Socket screws

Chrome-Vanadium, B = burnished

Clés mâles coudées pour vis TORX® intérieures

Chrome-Vanadium, B = brunies

Llaves macho, acodadas para tornillos TORX® interiores

Cromo Vanadio, B = pavonado



Code	Größe size	mm	mm	g		EAN
01348000630	T 6	1,67	42 x 16	3	10	027532
01348000730	T 7	1,99	48 x 16	3	10	027549
01348000830	T 8	2,31	48 x 16	3	10	027556
01348000930	T 9	2,50	48 x 16	3	10	027563
01348001030	T 10	2,74	51 x 17	4	10	027570
01348001530	T 15	3,27	54 x 18	5	10	027587
01348002030	T 20	3,86	57 x 19	8	10	027594
01348002530	T 25	4,43	60 x 20	12	10	027600
01348002730	T 27	4,99	64 x 21	13	10	027617
01348003030	T 30	5,52	70 x 24	20	10	027624
01348004030	T 40	6,65	76 x 26	30	10	027631
01348004530	T 45	7,82	83 x 29	43	10	027648
01348005030	T 50	8,83	95 x 32	62	10	027655
01348005530	T 55	11,22	110 x 35	115	10	027662
01348006030	T 60	13,25	115 x 43	175	10	027679

H 1348-8

Winkelschraubendreher-Satz für Innen-TORX®-Schrauben

in Handklapphaltern, (Halter vernickelt)

TORX®-Wrench set for TORX®-Socket screws

in metal holders, (holder nickel plated)

Jeux de clés mâles coudées pour vis TORX® intérieures

sur monture, (monture nickelée)

Juegos de llaves macho, acodadas para tornillos TORX® interiores

en monturas níqueladas



Code	Größe size	g		EAN
01348624030	T9 T10 T15 T20 T25 T27 T30 T40	235	5	027686

R 1348-10

Winkelschraubendreher-Satz für Innen-TORX®-Schrauben

in Rolltaschen, Kunststoff, mit Band

Hexagonal head wrench set for TORX®-Socket screws

in plastic wallets, with strap

Jeux de clés mâles coudées pour vis TORX® intérieures

en trousse plastique, avec lanière

Juegos de llaves macho, acodadas para tornillos TORX® interiores

en bolsas enrollables, de plástico, con correa



Code	Größe size	g		EAN
01348725530	T8 T10 T15 T20 T25 T27 T30 T40 T45 T50	260	1	027693

HP 1349-8

Kugelpf-Winkelschraubendreher-Satz für Innen-TORX®-Schrauben

Chrom-Vanadium, B = brüniert, in Kunststoffhaltern
Zum Schrauben von schwer zugänglich liegenden Innen-TORX®-Schrauben in einem Arbeitswinkel von bis zu 20°.

Ball head TORX®-Wrench set, "L"-shaped for TORX®-Socket screws

Chrome-Vanadium, B = burnished, in plastic holders
Spherical head permits usage on TORX®-socket screws located in confined or hard to reach areas, off-axis operation up to 20°.

Jeux de clés mâles coudées emmanchées à tête sphérique pour vis TORX® intérieures

Chrome-Vanadium, B = brunies, en monture plastique
Grâce à leur tête sphérique, ces clés permettent d'intervenir sur des vis TORX® peu accessibles dont l'inclinaison va jusqu'à 20°.

Cabeza esférica Juegos de llaves macho, acodadas para tornillos TORX® interiores

Cromo Vanadio, B = pavonado, sobre soporte-expositor de plástico
Para el atornillado de tornillos TORX® interiores en sitios de difícil acceso ángulo de trabajo de hasta 20°.

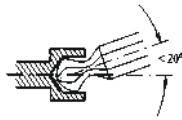

Code	tlg./pcs.	g		EAN
01349824030	8	164	1	099751

enthaltend/containing

T 9 T 10 T 15 T 20 T 25 T 27 T 30 T 40

1405

Kreuzschlitz-Schraubendreher für PHILLIPS-RECESS-Schrauben

Chrom-Vanadium, C = verchromt (mit schwarzer Spitze)
mit durchgehender Klinge und Hartholzheft mit Lederkappe,
Klinge mit Sechskant

Cross slot screwdrivers for cross slot screws PHILLIPS-RECESS

Chrome-Vanadium, C = chromium plated (with black tip)
with blade through handle and hardwood handle with leather cap,
blade with hexagon bolster

Tournevis cruciforme pour vis PHILLIPS-RECESS

Chrome-Vanadium, C = chromées (extrémité noire)
lame traversante et manche en bois dur avec une bague en cuir,
lame avec un six pans

Destornilladores para tornillos PHILLIPS-RECESS

Cromo Vanadio, C = cromado (con punta negra)
varilla pasante y mango de madera con remate de cuero,
varilla con hexágono

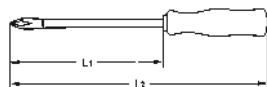

Code	No.	L ₁ mm	L ₂ mm	mm	g		EAN
01405001080	1	80	175	6	52	10	028065
01405002080	2	100	210	10	94	10	028072
01405003080	3	150	270	12	160	10	028089
01405004080	4	200	340	17	310	10	028096

1411

DIN/ISO 8764-2



Kreuzschlitz-Schraubendreher für PHILLIPS-RECESS-Schrauben

Chrom-Vanadium, C = verchromt (mit schwarzer Spitze)
mit schlagfestem Kunststoffheft, No. 3 + 4 = Klinge mit Sechskant

Cross slot screwdrivers for cross slot screws PHILLIPS-RECESS

Chrome-Vanadium, C = chromium plated (with black tip)
with shockproof plastic handle, No. 3 + 4 = blade with hexagon bolster

Tournevis cruciforme pour vis PHILLIPS-RECESS

Chrom-Vanadium, C = chromées (extrémité noire)
manche en matière plastique incassable, No. 3 + 4 = lame avec six pans

Destornilladores para tornillos PHILLIPS-RECESS

Cromo Vanadio, C = cromado (con punta negra)
mango de plástico antichoque, No. 3 + 4 = varilla con hexágono

Code	No.	L ₁ mm	L ₂ mm	mm	g		EAN
01411000180	01	25	85		44	10	028126
01411000280	02	25	85		48	10	028133
01411000080	0	60	135		25	10	028119
01411001080	1	80	170		48	10	028157
01411002080	2	100	200		81	10	028171
01411003080	3	150	260	13	170	10	028195
01411004080	4	200	325	16	275	5	028201

1411-01 + 02



1411-0 + 1 + 2



1411-3 + 4

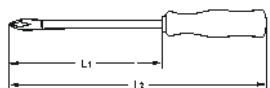

1412

DIN/ISO 8764-2



Kreuzschlitz-Schraubendreher für POZIDRIV®-Schrauben

Chrom-Vanadium, C = verchromt (mit schwarzer Spitze)
mit schlagfestem Kunststoffheft, No. 3 + 4 = Klinge mit Sechskant

Cross slot screwdrivers for cross slot screws POZIDRIV®

Chrome-Vanadium, C = chromium plated (with black tip)
with shockproof plastic handle, No. 3 + 4 = blade with hexagon bolster

Tournevis cruciforme pour vis POZIDRIV®

Chrom-Vanadium, C = chromées (extrémité noire)
manche en matière plastique incassable, No. 3 + 4 = lame avec un six pans

Destornilladores para tornillos POZIDRIV®

Cromo Vanadio, C = cromado (con punta negra),
mango de plástico antichoque, No. 3 + 4 = varilla con hexágono

Code	No.	L ₁ mm	L ₂ mm	mm	g		EAN
01412000180	01	25	85		44	10	028225
01412000280	02	25	85		48	10	028232
01412000080	0	60	135		25	10	028218
01412001080	1	80	170		48	10	028249
01412002080	2	100	200		81	10	028256
01412003080	3	150	260	13	150	10	028263
01412004080	4	200	325	17	275	5	028270

1412-01 + 02



1412-0 + 1 + 2



1412-3 + 4

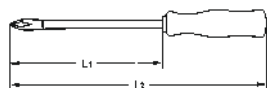

1415

Schraubendreher für Innen-TORX®-Schrauben

Chrom-Vanadium, C = verchromt (mit schwarzer Spitze)
mit schlagfestem Kunststoffheft

TORX®-Screwdrivers for TORX®-Socket screws

Chrome-Vanadium, C = chromium plated (with black tip)
with shockproof plastic handle

Tournevis TORX® pour vis TORX® intérieures

Chrom-Vanadium, C = chromées (extrémité noire)
manche en matière plastique incassable

Destornilladores para tornillos TORX® interiores

Cromo Vanadio, C = cromado (con punta negra)
mango de plástico antichoque

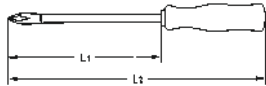

Code	Größe size	mm	L ₁ mm	L ₂ mm	g		EAN
01415000680	T 6	1,67	50	130	23	10	028287
01415000780	T 7	1,99	50	130	23	10	028294
01415000880	T 8	2,31	60	140	23	10	028300
01415000980	T 9	2,50	60	140	23	10	028317
01415001080	T 10	2,74	68	155	25	10	028324
01415001580	T 15	3,27	68	155	28	10	028331
01415002080	T 20	3,86	90	190	44	10	028348
01415002580	T 25	4,43	100	190	48	10	028355
01415002780	T 27	4,99	100	200	69	10	028362
01415003080	T 30	5,52	100	200	79	10	028379
01415004080	T 40	6,65	100	200	88	10	028386
01415004580	T 45	7,82	115	225	150	10	028393

1417

Aufreiber

N = vernickelt,
Kunststoffheft, konische Vierkantspitze

Bradawls

N = nickel plated,
with shockproof plastic handle, conical square point

Pointes carrées

N = nickelées,
manche en matière plastique incassable, pointe carrée conique

Punzones

N = niquelado,
mango de plástico antichoque, punta cónica cuadrada

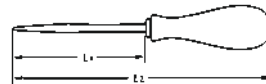

Code	Klingen-Ø blade-Ø mm	L ₁ mm	L ₂ mm	g		EAN
01417011050	6,0	100	190	82	10	100846

1430

DIN 5625 / ISO 2380-2

Werkstatt-Schraubendreher für Schlitzschrauben

Chrom-Vanadium, C = verchromt (mit schwarzer Spitze)
mit schlagfestem Kunststoffheft

Engineers' screwdrivers for plain slot screws

Chrome-Vanadium, C = chromium plated (with black tip)
with shockproof plastic handle

Tournevis mécanicien pour vis à fente

Chrom-Vanadium, C = chromées (extrémité noire)
manche en matière plastique incassable

Destornilladores para tornillos ranurados

Cromo Vanadio, C = cromado (con punta negra)
mango de plástico antichoque

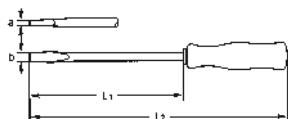

Code	a mm	b mm	L ₁ mm	L ₂ mm	g		EAN
01430010080	1,0	5,5	100	190	50	10	028539
01430012580	1,2	6,5	125	225	84	10	028546
01430015080	1,2	8	150	260	120	10	028553
01430020080	1,6	10	200	315	215	5	028560
01430025080	2,0	12	250	375	295	5	028577
01430030080	2,5	14	300	430	375	5	028584

1435

Elektriker-Schraubendreher für Schlitzschrauben

Chrom-Vanadium, C = verchromt (mit schwarzer Spitze)
mit schlagfestem Kunststoffheft

Electricians' screwdrivers for plain slot screws

Chrome-Vanadium, C = chromium plated (with black tip)
with shockproof plastic handle

Tournevis électricien pour vis à fente

Chrom-Vanadium, C = chromées (extrémité noire)
manche en matière plastique incassable

Destornilladores para electricistas para tornillos ranurados

Cromo Vanadio, C = cromado (con punta negra)
mango de plástico antichoque

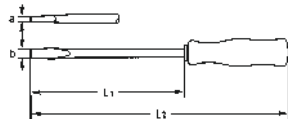

Code	a mm	b mm	L ₁ mm	L ₂ mm	g	g	EAN
01435006080	0,4	2,5	60	135	23	10	028591
01435007580	0,5	3	75	150	25	10	028607
01435010080	0,5	3	100	175	26	10	028614
01435012580	0,8	4	125	215	47	10	028621
01435015080	0,8	5	150	250	73	10	028638
01435017580	0,8	5	175	275	75	10	028645
01435020080	0,8	5	200	295	82	10	028652

1436

Elektriker-Schraubendreher für Schlitzschrauben

Chrom-Vanadium, CI = verchromt, Klinge mit Kunststoff überzogen
(mit schwarzer Spitze) mit schlagfestem Kunststoffheft

Electricians' screwdrivers for plain slot screws

Chrome-Vanadium, CI = chromium plated, blade with insulation
(with black tip) with shockproof plastic handle

Tournevis électricien pour vis à fente

Chrom-Vanadium, CI = chromées, lame gainée plastique
(extrémité noire), manche en matière plastique incassable

Destornilladores para electricistas para tornillos ranurados

Cromo Vanadio, CI = cromado, varilla plastificada
(con punta negra) mango de plástico antichoque

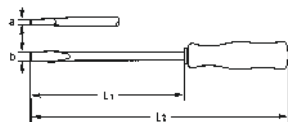

Code	a mm	b mm	L ₁ mm	L ₂ mm	g	g	EAN
01436006085	0,4	2,5	60	135	24	10	028669
01436007585	0,5	3	75	150	27	10	028683
01436010085	0,5	3,5	100	190	44	10	028706
01436012585	0,8	4	125	215	50	10	028737
01436015085	0,8	5	150	245	76	10	028751
01436017585	0,8	5	175	270	81	10	028775
01436020085	0,8	5	195	300	86	10	028782

1437

DIN 5265 D / ISO 2380-2

Werkstatt-Schraubendreher für Schlitzschrauben

Chrom-Vanadium, C = verchromt (mit schwarzer Spitze)
Klinge mit Sechskant, mit schlagfestem Kunststoffheft

Engineers' screwdrivers for plain slot screws

Chrome-Vanadium, C = chromium plated (with black tip)
blade with hexagon bolster with shockproof plastic handle

Tournevis mécanicien pour vis à fente

Chrom-Vanadium, C = chromées (extrémité noire)
lame avec un six pans manche en matière plastique incassable

Destornilladores para tornillos ranurados

Cromo Vanadio, C = cromado (con punta negra)
varilla con hexágono, mango de plástico antichoque

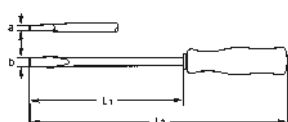

Code	a mm	b mm	L ₁ mm	L ₂ mm	mm	g	g	EAN
01437010080	1,0	5,5	100	200	8	68	10	028799
01437012580	1,2	6,5	125	235	10	100	10	028805
01437015080	1,2	8	150	260	13	130	10	028812
01437017580	1,6	10	175	295	13	185	10	028829
01437020080	2,0	12	200	325	16	240	5	028836
01437025080	2,5	14	250	380	16	300	5	028843

1445

Vergaser-Schraubendreher für Schlitzschrauben

Chrom-Vanadium, C = verchromt (mit schwarzer Spitze)
mit schlagfestem Kunststoffheft

Stubby screwdrivers for plain slot screws

Chrome-Vanadium, C = chromium plated (with black tip)
with shockproof plastic handle

Tournevis boule à lame courte pour vis à fente

Chrom-Vanadium, C = chromées (extrémité noire)
manche en matière plastique incassable

Destornilladores modelo extracorto para tornillos ranurados

Cromo Vanadio, C = cromado (con punta negra)
mango de plástico antichoque

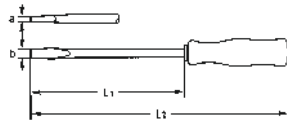

Code	a mm	b mm	L ₁ mm	L ₂ mm	g	g	EAN
01445004080	0,8	4	25	85	40	10	028881
01445006080	1,2	6,5	25	85	46	10	028898

1470

Werkstatt-Schraubendreher für Schlitzschrauben

Chrom-Vanadium, C = verchromt (mit schwarzer Spitze)
mit durchgehender Klinge und Hartholzheft mit Lederkappe,
Klinge mit Sechskant

Engineers' screwdrivers for plain slot screws

Chrome-Vanadium, C = chromium plated (with black tip)
with blade through handle and hardwood handle with leather cap,
blade with hexagon bolster

Tournevis mécanicien pour vis à fente

Chrom-Vanadium, C = chromées (extrémité noire)
lame traversante et manche en bois dur avec une bague en cuir,
lame avec un six pans

Destornilladores para tornillos ranurados

Cromo Vanadio, C = cromado (con punta negra)
varilla pasante y mango de madera con remate de cuero,
varilla con hexágono

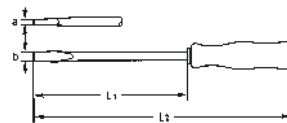

Code	a mm	b mm	L ₁ mm	L ₂ mm	mm	g	g	EAN
01470007580	0,6	3,5	75	170	6	47	10	029017
01470009080	0,8	4,5	90	185	6	50	10	029024
01470010080	1,0	5,5	100	200	8	66	10	029031
01470012580	1,2	7	125	235	10	105	10	029048
01470015080	1,2	8	150	270	12	160	10	029055
01470017580	1,6	10	175	300	12	180	10	029062
01470020080	2,0	12	200	330	13	230	5	029079
01470025080	2,5	14	250	390	16	325	5	029086

1452 - 1454

Schraubendreher-Sätze

Chrom-Vanadium,
N = vernickelt, C = verchromt, CI = verchromt, Klinge isoliert

Screwdriver sets

Chrome-Vanadium,
N = nickel plated, C = chromium plated, CI = chromium plated,
blade insulated

Jeux de tournevis

Chrom-Vanadium,
N = nickelées, C = chromées, CI = chromées, lame

Juegos de destornilladores

Cromo Vanadio,
N = niquelado, C = cromado, CI = cromado, varilla plastificada



Code	No.	tlg./pcs.			EAN
01452000080	1452	7	470	1	028928

enthaltend/containing

Stck. pcs.	Artikel/article	No.	Maße/size
je 1 each		1430 C	5,5 x 100 6,5 x 125 8 x 150 mm
1		1424 N	3 x 65 mm
1		1436 CI	3 x 75 mm
je 1 each		1411 C	No. 1 2

Code	No.	tlg./pcs.			EAN
01454000080	1454	7	470	1	028935

wie 1452, jedoch/as 1452, but

Stck. pcs.	Artikel	No.	Maße/size
je 1 each		1412 C	No. 1 2

1456 - 1458

Schraubendreher-Sätze

Chrom-Vanadium, C = verchromt

Screwdriver sets

Chrome-Vanadium, C = chromium plated

Jeux de tournevis

Chrom-Vanadium, C = chromées

Juegos de destornilladores

Cromo Vanadio, C = cromado



Code	No.	tlg./pcs.			EAN
01456000080	1456	7	460	1	028942

enthaltend/containing

Stck. pcs.	Artikel/article	No.	Maße/size
je 1 each		1430 C	6,5 x 125 8 x 150 mm
je 1 each		1435 C	2,5 x 60 3 x 75 3 x 100 mm
je 1 each		1411 C	No. 1 2

Code	No.	tlg./pcs.			EAN
01458000080	1458	7	460	1	028959

wie 1456, jedoch/as 1456, but

Stck. pcs.	Artikel	No.	Maße/size
je 1 each		1412 C	No. 1 2

1460

Schraubendreher-Satz für Innen-TORX®-Schrauben

Chrom-Vanadium, C = verchromt

Screwdriver set for TORX®-Socket screws

Chrome-Vanadium, C = chromium plated

Jeux de tournevis pour vis TORX® intérieures

Chrom-Vanadium, C = chromées

Juegos de destornilladores para tornillos TORX® interiores

Cromo Vanadio, C = cromado



Code	No.	tlg./pcs.			EAN
01460000080	1460	8	455	1	028966

enthaltend/containing

Stck. pcs.	Artikel/article	No.	Maße/size
je 1 each		1415 C	T 8 T 9 T 10 T 15 T 20 T 25 T 27 T 30

1471

Schraubendreher-Satz

Chrom-Vanadium,
N = vernickelt, C = verchromt, CI = verchromt, Klinge isoliert

Screwdriver set

Chrome-Vanadium,
N = nickel plated, C = chromium plated, CI = chromium plated,
blade insulated

Jeu de tournevis







Chrome-Vanadium,
N = nickelées, C = chromées, CI = chromées, lame

Juego de destornilladores

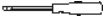
Cromo Vanadio,
N = niquelado, C = cromado, CI = cromado, varilla plastificada

Code	No.	tlg./pcs.			EAN
01471000080	1471	6	470	1	457810

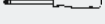
enthaltend/containing

Stck. pcs.	Artikel/article	No.	Maße/size
je 1 each			3.5 x 75 mm
			4.5 x 90 mm
			5.5 x 100 mm
			7.0 x 125 mm
je 1 each			No. 1 2

NEU
NEW



1472

Schraubendreher-Satz

Chrom-Vanadium,
N = vernickelt, C = verchromt, CI = verchromt, Klinge isoliert

Screwdriver set



Chrome-Vanadium,
N = nickel plated, C = chromium plated, CI = chromium plated,
blade insulated

Jeu de tournevis







Chrome-Vanadium,
N = nickelées, C = chromées, CI = chromées, lame

Juego de destornilladores

Cromo Vanadio,
N = niquelado, C = cromado, CI = cromado, varilla plastificada

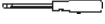
Code	No.	tlg./pcs.			EAN
01472000080	1472	6	470	1	457827

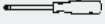
enthaltend/containing

Stck. pcs.	Artikel/article	No.	Maße/size
je 1 each			5.5 x 100 mm
			7.0 x 125 mm
			8.0 x 150 mm
je 1 each			No. 1 2 3

NEU
NEW



SICHERHEITSWERKZEUGE

INSULATED SAFETY TOOLS



1000 Volt/IEC 900/DIN EN 60900
1000 Volt/IEC 900/DIN EN 60900

1411

DIN 7438



VDE Kreuzschlitz-Schraubendreher für PHILLIPS-RECESS-Schrauben

Chrom-Vanadium, BV = brüniert, schutzisoliert gemäß DIN EN 60900 mit eingespritzt ummantelter Klinge, mit schlagfestem Kunststoffheft

VDE Cross slot screwdrivers for cross slot screws PHILLIPS-RECESS

Chrome-Vanadium, BV = burnished, VDE 1000 volt insulated, complying with DIN EN 60900, insulation of blade, and handle injection moulded as one unit, with shockproof plastic handle

VDE Tournevis cruciforme pour vis PHILLIPS-RECESS

Chrome-Vanadium, BV = brunis, isolés VDE 1000 volt, conforme aux spécifications VDE 0680/2, isolation de la lame par injection, manche en matière plastique incassable

VDE Destornilladores para tornillos PHILLIPS-RECESS

Cromo Vanadio, BV = pavonado, mangos con funda de plástico, protección cumple DIN EN 60900, aislamiento de la varilla, inyectado, mango de plástico antichoque

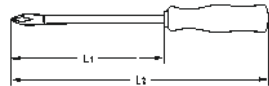

Code	No.	L ₁ mm	L ₂ mm	g		EAN
01411000033	0	60	140	24	10	028102
01411001033	1	80	170	42	10	028140
01411002033	2	100	200	70	10	028164
01411003033	3	150	260	130	10	028188



1000 Volt

1436

DIN 7437



VDE Elektriker-Schraubendreher für Schlitzschrauben

Chrom-Vanadium, BV = brüniert, schutzisoliert gemäß DIN EN 60900 mit eingespritzt ummantelter Klinge, mit schlagfestem Kunststoffheft

VDE Electricians' screwdrivers for plain slot screws

Chrome-Vanadium, BV = burnished, VDE 1000 volt insulated, complying with DIN EN 60900, insulation, of blade and handle injection moulded as, one unit with shockproof plastic handle

VDE Tournevis électricien pour vis à fente

Chrome-Vanadium, BV = brunis, isolés VDE 1000 volt, conforme aux spécifications VDE 0680/2, isolation de la lame par injection manche en matière plastique incassable

VDE Destornilladores para electricistas para tornillos ranurados

Cromo Vanadio, BV = pavonado, mangos con funda de plástico, protección, cumple DIN EN 60900, aislamiento de la varilla inyectado, mango de plástico antichoque

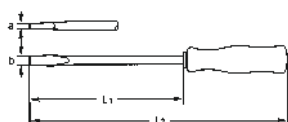

Code	a mm	b mm	L ₁ mm	L ₂ mm	g		EAN
01436007533	0,4	2,5	75	155	21	10	028676
01436010033	0,5	3,5	100	180	28	10	028690
01436010133	0,8	4,0	100	185	40	10	028713
01436012533	1,0	5,5	125	225	70	10	028720
01436015033	1,2	6,5	150	255	105	10	028744
01436017533	1,2	8,0	175	280	145	10	028768



1000 Volt

1450

VDE Schraubendreher-Satz

Chrom-Vanadium, BV = brüniert, schutzisoliert gemäß DIN EN 60900

VDE Screwdriver set

Chrome-Vanadium, BV = burnished, insulated complying with DIN EN 60900

VDE Jeux de tournevis

Chrome-Vanadium, BV = brunis, isolés VDE 1000 volt

VDE Juegos de destornilladores

Cromo Vanadio, BV = pavonado, protección cumple DIN EN 60900



Code	tlg./pcs.			EAN
0145000033	7	475	1	028911

enthaltend/containing

Stck. pcs.	Artikel/article	No.	Maße/size
je 1 each		1436 VDE	2,5 x 75 4 x 100 5,5 x 125 6,5 x 150 mm
1		1424 N	3 x 65 mm
je 1 each		1411 VDE	No. 1 2



1000 Volt

49-5

VDE-Elektriker Werkzeug-Garnitur

Modern das Design, klein der Raum, groß der Inhalt. Die kompakt und modern gestaltete Box aus Polypropylen ist stoßunempfindlich, schlagfest, temperatur-, öl-, säure- und benzinbeständig. Inhalt nach IEC 900/DIN EN 60900/VDE 0682 Teil 201. Kunststoffbox 370 x 270 x 56 mm.

VDE Electricians tool-set

Modern in design, space-saving, with a large assortment of first class quality tools.

The compact and modern styled box, which is manufactured from polypropylene is shock-proof, resistant to impact, temperature, oil, acid and petrol.

Contents with IEC 900/DIN EN 60900/VDE 0682 part 201 certification. Plastic box 370 x 270 x 56 mm.

VDE Composition d'outils VDE pour électricien

Moderne par son design, modeste par son encombrement, large et complet, par sa composition.

Ce coffret compact et moderne, en polypropylène, est insensible aux chocs, résistant aux variations de température, aux huiles, aux acides et à l'essence. Contenu conforme aux tests EN.

Coffret en matière plastique 370 x 270 x 56 mm.

Conjunto de herramientas para electricista VDE

Diseño moderno, volumen reducido, contenido amplio.

El maletín compacto y moderno resiste golpes, calor, aceite, ácido y gasolina.

Contenido según norma IEC 900/DIN EN 60900/VDE 0682 apartado 201. Maletín de plástico 370 x 270 x 56 mm.



Code	tlg. pcs.	Maße dimensions			EAN
00049000500	9	370 x 270 x 56 mm	1520	1	002188

enthaltend/containing

Stck. pcs.	Artikel/article	No.	Maße/dimensions
1		1208 VDE CPV	160 mm
1		1213 VDE CPV	140 mm
1		1220 VDE CPV	160 mm
2		1411 VDE BV	PH No. 1 2
1		1427 VDE ST	65 x 3 mm
3		1436 VDE BV	75 x 2,5 100 x 4 125 x 5,5 mm



1054

Rucksack für Werkzeugsortimente, leer

Maße 440 x 360 x 170 mm. Hochwertiger Rucksack mit 32 innenliegenden und 4 außenliegenden Einsteckfächern, einem Laptopfach (bis 13,3"), sowie 12 Gummischlaufen für Werkzeuge aller Art. Der Rucksack wird aus strapazierfähigem Nylon gefertigt und ist durch die stabil genähten Einsteckfächer sowie die verstärkte Bodenplatte extrem langlebig.

Ausstattungsmerkmale: Robuste Tragegriffe, ergonomisch gepolsterter Rückenbereich, verstellbare, weich gepolsterte Schulterriemen, rutschfeste, gummierte Bodenplatte zum Schutz vor Abnutzung und Nässe, Maßbandhalter, Schlüsselanhänger, mehrere Metallbefestigungsösen, stabile Reißverschlüsse. Info: Neben dem leeren Rucksack bieten wir auch ein VDE Elektriker Sortiment an.

Backpack for tool assortments, empty

Dimensions 440 x 360 x 170 mm. High-quality backpack with 32 pockets, a laptop compartment (up to 13.3"), 4 external storage compartments and 12 rubber loops for tools of all kinds. The backpack is made from hard-wearing nylon and is extremely durable thanks to the sturdy sewn-in compartments and reinforced base plate.

Equipment features: Robust carrying handles, ergonomically padded back area, adjustable, soft padded shoulder straps, non-slip, rubberised base plate to protect against wear and tear and moisture, tape measure holder, key fob, several metal fastening eyelets, sturdy zips. Info: In addition to the empty backpack, we also offer a VDE electrician's range.

Sac à dos pour assortiments d'outils, vide

Dimensions 440 x 360 x 170 mm. Sac à dos de haute qualité avec 32 poches intérieures et 4 poches extérieures, un compartiment pour ordinateur portable (jusqu'à 13,3") et 12 boucles en caoutchouc pour toutes sortes d'outils. Le sac à dos est fabriqué en nylon résistant et a une durée de vie extrêmement longue grâce aux compartiments solidement cousus et à la plaque de fond renforcée.

Caractéristiques de l'équipement: Poignées robustes, dos ergonomiquement rembourré, bretelles réglables et souples, plaque de fond antidérapante et caoutchoutée pour protéger de l'usure et de l'humidité, porte-mètre, porte-clés, plusieurs œillets de fixation en métal, fermetures éclair solides. Info: En plus du sac à dos vide, nous proposons également un assortiment VDE pour électriciens.

Mochila para surtido de herramientas, vacía

Dimensiones 440 x 360 x 170 mm. Mochila de alta calidad con 32 bolsillos, un compartimento para portátil (hasta 13,3"), 4 compartimentos de almacenamiento externos y 12 trabillas de goma para herramientas de todo tipo. La mochila está fabricada en nylon resistente y es extremadamente duradera gracias a los robustos compartimentos cosidos y a la placa base reforzada.

Características de equipamiento: Robustas asas de transporte, zona de la espalda ergonómicamente acolchada, tirantes acolchados suaves y ajustables, placa base de goma antideslizante para proteger contra el desgaste y la humedad, soporte para cinta métrica, llavero, varios ojales metálicos de fijación, cremalleras resistentes. Información: Además de la mochila vacía, también ofrecemos una gama para electricistas VDE.

Code	tlg./pcs.			EAN
01054000000	1	1600	1	457643

NEU
NEW



1054-14

Elektriker Rucksack mit VDE-Werkzeugsortiment, 13-tlg.

Maße 440 x 360 x 170 mm. Hochwertiger Rucksack mit 32 innenliegenden und 4 außenliegenden Einsteckfächern, einem Laptopfach (bis 13,3"), sowie 16 Gummischlaufen für Werkzeuge aller Art.

Electrician's backpack with VDE tool assortment, 13 pcs.

Dimensions 440 x 360 x 170 mm. High-quality backpack with 32 pockets, a laptop compartment (up to 13.3"), 4 external storage compartments and 16 rubber loops for tools of all kinds.



Sac à dos d'électricien avec assortiment d'outils VDE, 13 pcs.









Dimensions 440 x 360 x 170 mm. Sac à dos de haute qualité avec 32 poches intérieures et 4 poches extérieures, un compartiment pour ordinateur portable (jusqu'à 13,3") et 16 boucles en caoutchouc pour toutes sortes d'outils.

Mochila de electricista con juego de herramientas VDE, 13 pzs.

Dimensiones 440 x 360 x 170 mm. Mochila de alta calidad con 32 bolsillos, un compartimento para portátil (hasta 13,3"), 4 compartimentos de almacenamiento externos y 16 trabillas de goma para herramientas de todo tipo.

NEU
NEW

Code	tlg./pcs.			EAN
01054001400	13	3005	1	460032

enthaltend/containing			
Stück. pcs.	Artikel/article	No.	Maße/size
1		1208 VDE CPV	200 mm
1		1200 VDE CPV	180 mm
1		1213 VDE CPV	160 mm
1		1220 VDE CPV	160 mm
2		4511 VDE BV	PH No. 1 / 2
4		4536 VDE BV	75 x 2,5 100 x 4 125 x 5,5 150 x 6,5 mm
1		1427 VDE	60 x 3 150-250 V
1		1920	10 m
1		1426 VDE	6-1000 V



1419

Auto-Lichtprüfer 6 – 24 Volt

MS = Messing

Messingkörper, mit Prüfspitze, Schutzkappe und festem Kabel mit Masseklemme, zur Kontrolle von Licht- und Zündanlagen an Kraftfahrzeugen

Car light tester 6 – 24 Volt

MS = brass

Brass body, with contact point, protective screw cap and fixed cable, with alligator clip, for checking electric circuits on motor cars.

Contrôleurs de tension 6 – 24 Volt

MS = laiton

Corps en laiton, avec pointe-déetectrice, capuchon et cable fixe avec pince crocodile, pour contrôler l'installation d'éclairage et d'allumage des véhicules.

Buscapolos para automóvil 6 – 24 voltios

MS = latón,

Cuerpo de latón, con punta de contacto, caperza protectora y cable fijo, con pinza, para comprobar alumbrado y encendido en automóviles.



Code	←L→ mm	⚖ g		EAN
01419000045	120	67	10	028423

1420

Auto-Lichtprüfer 6 – 24 Volt

N = vernickelt

60 cm langes Kabel mit Masseklemme zur Kontrolle von Licht- und Zündanlagen an Kraftfahrzeugen.

Car light tester 6 – 24 Volt

N = nickel plated

60 cm long cable with earthing clip, for checking electric circuits on motor cars.

Contrôleurs de tension 6 – 24 Volt

N = nickelées

Cordon de 60 cm avec pince de masse, pour le contrôle des installations, d'éclairage et d'allumage des véhicules.

Buscapolos para automóvil 6 – 24 voltios

N = niquelado

Cable de 60 cm de largo, con pinza de conexión de masa, para comprobar, instalaciones de alumbrado y encendido de automóviles.

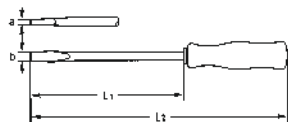

Code	a mm	b mm	L ₁ mm	L ₂ mm	⚖ g		EAN
01420000050	0,7	3	44	120	22	10	028430

1424

Spannungsprüfer für 220 – 250 Volt

N = vernickelt, mit Metall-Clip

Voltage tester for 220 – 250 Volt

N = nickel plated, with pocket clip

Tournevis détecteurs de tension pour 220 – 250 Volt

N = nickelées, avec agrafe

Destornilladores buscapolos para 220 – 250 voltios

N = niquelado, con clip metálico

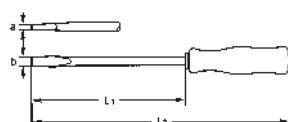

Code	a mm	b mm	L ₁ mm	L ₂ mm	⚖ g		EAN
01424000050	0,5	3	65	140	18	10	028461



1425

Spannungsprüfer für 220 – 250 Volt

N = vernickelt

Voltage tester for 220 – 250 Volt

N = nickel plated

Tournevis détecteurs de tension pour 220 – 250 Volt

N = nickelées

Destornilladores buscapolos para 220 – 250 voltios

N = niquelado

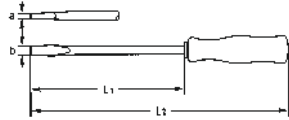

Code	a mm	b mm	L ₁ mm	L ₂ mm	g	g	EAN
01425000050	0,5	3,5	100	195	36	10	028485



1426

VDE Spannungsprüfer Profi III LED

6 – 1000 Volt

Elektronische Spannungsanzeige mit 3 voneinander unabhängigen Anzeigesystemen, zweipolig.

VDE Voltage tester Profi III LED

6 – 1000 Volt

Electronic voltage indication with 3 independent reading systems, bipolar.

VDE Tournevis détecteurs de tension Profi III LED

6 – 1000 Volt

Indication de tension électronique avec 3 affichages indépendants, bipolaire.

VDE Buscapolos Profi III LED

6 – 1000 voltios

Indicador electrónico del voltaje mediante 3 sistemas, independientes, bipolar.



Code	g	g	EAN
01426000000	185	1	028492

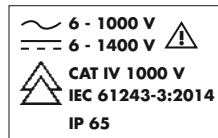

1427

VDE Spannungsprüfer für 150 – 250 Volt

ST = standardmäßig, mit Metall-Clip

VDE Voltage tester for 150 – 250 Volt

ST = standard, with pocket clip

VDE Tournevis détecteurs de tension, pour 150 – 250 Volt

ST = standard, avec agrafe

VDE Buscapolos para 150 – 250 voltios

ST = estándar, con clip metálico

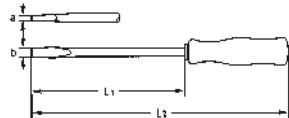

Code	a mm	b mm	L ₁ mm	L ₂ mm	g	g	EAN
01427000000	0,6	3	65	152	27	10	028508



1479

Umsteck-Schraubendreher für Schlitz- und Kreuzschlitzschrauben

Chrom-Vanadium, C = verchromt, mit schlagfestem Kunststoffheft

Reversible screwdriver for plain slot and cross slot screws

Chrome-Vanadium, C = chromium plated, with shockproof plastic handle

Tournevis lame réversible pour vis à fente et cruciformes

Chrome-Vanadium, C = chromées, manche en plastique incassable

Destornilladores intercambiables punta plana y punta cruciforme

Cromo Vanadio, C = cromado, mango de plástico antichoque



Code	No.	mm	mm	mm	g	g	EAN
01479000080	2	6	140	90	62	10	029116

1480

Universal-Schalterschrankschlüssel

Universell einsetzbar für fast alle gängigen Schließsysteme in der: Elektrotechnik, Gas- und Wasserversorgung, Heizung-, Klima- und Sanitärbereich.

Universal control cabinet key

All-purpose device for prevalent locking systems in the field of electro-technics, gas and water supply, heating, air conditioning and sanitary installations.

Clé universelle pour armoires de commande

Pour installations techniques dans les batiments telles que climatisation et ventilation, chauffage et installations sanitaires.

Llave universal para armarios

Uso universal para la práctica totalidad de los sistemas de cierre en electrotécnica, suministro de gas y de agua, y en el ámbito de calefacción, climatización y sanitario.

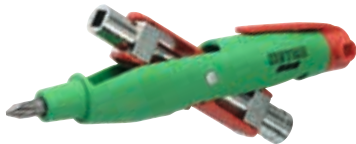

Code	für/for	 g		EAN
0148000060	1/4"	130	1	362114

Durch einen doppelten Drehmechanismus können vier verschiedene Schließungen in Position gebracht werden.

Eine 1/4" Bitaufnahme ermöglicht den Einsatz aller handelsüblichen Bits. Ein Neodym Dauermagnet hält den Bit sicher in der Aufnahme.

Four different locking positions can be selected by a double rotary-mechanism. The 1/4" bit adaptor allows the utilisation of all standard bits. A Neodym permanent magnet securely keeps the bit in its position.



1483

DIN 5200



Winkelschraubendreher für Schlitzschrauben

Chrom-Vanadium, N = vernickelt

Offset screwdrivers for plain slot screws

Chrome-Vanadium, N = nickel plated

Tournevis coudés pour vis à fente

Chrome-Vanadium, N = nickelées

Destornilladores acodados punta plana

Cromo Vanadio, N = niquelado



1484

DIN 5208



Winkelschraubendreher für Kreuzschlitzschrauben

Chrom-Vanadium, N = vernickelt

Offset screwdrivers for cross slot screws

Chrome-Vanadium, N = nickel plated





Tournevis coudés pour vis cruciformes

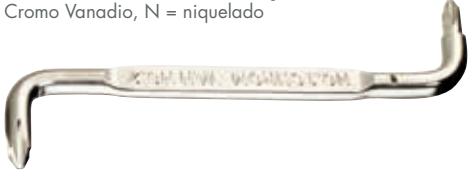

Chrome-Vanadium, N = nickelées

Destornilladores acodados punta cruciforme

Cromo Vanadio, N = niquelado



Code	 mm	$\leftarrow L \rightarrow$ mm	 mm	 g		EAN
01483010050	4	100	0,8	13	10	113860
01483012550	5,5	125	1,0	30	10	114133
01483015050	8	150	1,2	50	10	113877
01483017550	10	175	1,6	78	10	113884
01483020050	12	200	2,0	135	10	113891

Code	No.	$\leftarrow L \rightarrow$ mm	 g		EAN
01484010250	1 + 2	100	27	10	113907
01484030450	3 + 4	200	155	10	113914

1491

Schraubenausdreher-Sätze

Chrom-Vanadium, ST = standardmäßig

Zum Entfernen von abgebrochenen Schrauben und Gewindebolzen mit Rechtsgewinde.

Screw extractor sets

Chrome-Vanadium, ST = standard

For removing broken screws and studs with right hand thread.

Jeux d'extracteurs de goujons cassés

Chrome-Vanadium, ST = standard

Pour extraction des goujons cassés et des boulons filetés à droite.



Juegos de extractores de tornillos

Cromo Vanadio, ST = estándar

Para extraer tornillos y bulones rotos, con rosca a la derecha.



In Kunststoffbox.
In plastic boxes.

Code	tlg./pcs.	für Schrauben/for screws M		 g		EAN
01491000500	5	3 – 18	1/8 – 3/4	115	1	029192
01491000600	6	3 – 24	1/8 – 1	220	1	029208
01491000800	8	3 – 45	1/8 – 1.3/4	700	1	029215

1494

Magneheber

CPP = verchromt

Ganz poliert, mit flexiblem Schaft und Kunststoffheft.

Magnetic pick-up tools

CPP = chromium plated

Fully polished, with flexible shaft and plastic handle.

Doigts magnétiques

CPP = chromées

Entièrement polis, avec tige flexible et manche en plastique.

Extractores magnéticos flexibles

CPP = cromado

Enteramente pulido espejo, mango de plástico.



Code	No.	Zugkraft lifting capacity g	Magnet magnet Ø-mm	←L→ mm			EAN
01494000183	1494-1	500	6	470	89	5	029307
01494000283	1494-2	1800	12	535	265	5	029314
01494000383	1494-3	3000	16	550	305	5	029321

1495-3

Krallengreifer

C = verchromt, mit LED und Magnet

Greiffunktion über Magnetheber oder über 3-Arm Krallengreifer. Zum Greifen von Kleinteilen an schwer zugänglichen Stellen mit flexiblem Schaft. Helle LED zum Ausleuchten von dunklen Stellen.

3-Claw pick-up tool

C = chromium plated, with LED and magnet

Grip function by magnetic pick-up tool or 3-claw pick-up tool. For retrieving small parts from confined or hard to reach areas with flexible shaft. Bright LED illuminate dark areas.

Doigts magnétiques

C = chromées, avec LED et aimant

Fonction de préhension par l'intermédiaire de levage magnétique, par griffe de préhension 3 bras. Avec tige flexible et manche en plastique. LED lumineux pour éclairer les zones sombres.

Pinza de extracción

C = cromado, con LED y imán

Función de agarre por imán, por garra de 3 uñas. Para extraer piezas pequeñas de sitios de difícil acceso con varilla flexible. Potente LED para alumbrar sitios oscuros.



Code	←L→ mm	Greif-Ø gripping-Ø max. mm			EAN
01495000380	650	7	263	1	371444



1496-2 1497

Teleskop-Spiegel

N = vernickelt

Vielfache Verstellmöglichkeiten durch Teleskop-Schaft und Spiegelkopf-Gelenk, mit Kunststoffheft.

Telescopic inspection mirrors

N = nickel plated

Numerous adjustment alternatives with telescopic shaft and joint on mirror head, with plastic handle.

Miroirs orientables

N = nickelées

Ajustabilité multiple par tige télescopique et miroir articulé, avec manche en plastique.

Espejos de inspección telescópicos

N = niquelado

Ajuste variable mediante varilla telescópica y articulación mango de plástico.



1496-2



1497

Code	No.	Spiegelmaße dimensions of mirror mm	←L→ mm			EAN
01496000250	1496-2	Ø 60	280 – 750	90	1	029369
01497000050	1497	68 x 38	280 – 750	94	1	029376

1496-2 runde Spiegelform, Ø 60 mm
1496-2 round mirror, Ø 60 mm

1497 rechteckige Spiegelform, 68 x 38 mm
1497 rectangular mirror, 68 x 38 mm

ERGONOMISCHER 2-KOMPONENTEN SOFTGRIFF.

ERGONOMIC 2 COMPONENT SOFT GRIP.

Klingen aus Spezialstählen präzise gefertigt,
vernickelt und matt verchromt.

Blades manufactured from selected special
steels, nickel and mat chromium plated.

Lames en aciers spéciaux fabriquées avec
précision, nickelées et chromées mat.

Varillas de aceros especiales, de gran
precisión, niqueladas y cromadas mate.

Black tip Spitze für Präzision
und Passgenauigkeit.

Black tip for precision fit.

Extrémité brunie pour un
ajustage de précision.

Punta pavonada con
exactitud de medida.

Bei Sechskantklingen zusätzlicher
Aussensechskant zum Aufsetzen eines
Schraubenschlüssels.

Additional hexagonal bolster on hexagonal
blades for assistance of spanner.

Lames hexagonales équipées d'un épaulement
hexagonal complémentaire pour adapter une clé
de serrage.

En el caso de varillas exagonales, exágono
exterior para aplicar una llave de tuerca.





Zwei Flächen als Rollschutz.
Two flattened areas as anti-roll feature.
Deux plats de stabilité.
Dos chaflanes para que el mango no pueda rodar.

Hartkomponente mit nahtfreier Kappe zum Aufbringen der Axialkraft bei minimaler Reibung.
Hard component with seamless cap for maximum comfort and transmission of axial force.
Extrémité en matière dure, lisse, sans joint, pour obtenir confort et force dans l'axe.
Componente de plástico duro, extremo sin rebarba, para aplicar la fuerza axial con un mínimo de fricción.

Abrutschbremse und Schnelldrehzone.
Slip guard with spinning characteristic.
Proteccion antidérapante et zone de vissage rapide.
Tope para evitar que la mano resbale y zona de giro rápido.

Weichmantel für maximalen Reibschluss und Aufbringung höchster Drehmomente.
Soft grip outer material for maximum friction and highest torque.
Surface tendre antidérapante pour une meilleure transmission du couple de serrage.
Recubrimiento blando para un agarre firme y una óptima transmisión del par de giro.

Flansch gegen axiale Verdrehung (speziell für runde Klingen).
Flange to prevent axial torsion (in particular with round blades).
Ergot pour résister à la torsion axiale (Particulièrement pour lames rondes).
Saliente para evitar que la varilla gire en el mango (especialmente en el caso de varillas redondas).

Querbohrung zum Aufhängen des Werkzeugs und zum Einstecken eines Drehstiftes zur Erhöhung der Drehkraft.
Hanging hole for easy storage or inserting lever for additional torque.
Trou transversal pour pendre l'outil et pour pouvoir introduire une broche afin d'augmenter la force de rotation.
Agujero transversal para colgar la herramienta e introducir un bandador ara aumentar el par de giro.

Optimal ergonomisch ausgearbeiteter Sechskantgriff mit abgeflachten Kanten und angenehm griffiger Weichkomponente.
Most ergonomically designed handle with flattened edges and non-slip soft grip outer material.
Ergonomie optimale du manche hexagonal avec des arêtes aplanies et en matière souple et antidérapante.
Mango ergonómico de perfil hexagonal con cantos redondeados y un componente de plástico blando de tacto agradable y firme.

4500 - 4502

Verkaufsständer mit 2K Schraubendreher, 55-tlg., für Schlitz-, Kreuzschlitz-, und TORX®-Schrauben
ST = standardmäßig. Metallständer 470 x 210 x 360 mm.

2K Screwdrivers display stands, 55 pcs., for plain slot, cross slot and TORX®-Screws
ST = standard. Metal display 470 x 210 x 360 mm.

Présentoirs de tournevis 2K, 55 pcs., pour vis à fente, cruciforme et TORX®
ST = standard. Présentoirs en métal 470 x 210 x 360 mm.

Expositor de destornilladores 2K de 55 piezas, para tornillos de punta plana, cruciforme y TORX®
ST = standard. Soporte metálico 470 x 210 x 360 mm.

Code	No.	tlg./pcs.			EAN
0450000000	4500	55	7420	1	166446

enthaltend/containing			
Stck. pcs.	Artikel/article	No.	Maße/size
je 5 each		4512 C	No. 1 2
je 5 each		4530 C	5,5 x 100 6,5 x 125 8 x 150 mm
je 5 each		4535 C	3 x 75 3,5 x 100 mm
je 5 each		4537 C	5,5 x 100 6,5 x 125 8 x 150 10 x 175 mm

Code	No.	tlg./pcs.			EAN
0450100000	4501	55	6140	1	166453

enthaltend/containing			
Stck. pcs.	Artikel/article	No.	Maße/size
je 5 each		4511 C	No. 1 2
je 5 each		4530 C	5,5 x 100 6,5 x 125 8 x 150 mm
je 5 each		4535 C	3 x 75 3,5 x 100 4 x 125 mm
je 5 each		4515 C	T20 T25 T30

Code	No.	tlg./pcs.			EAN
0450200000	4502	55	4835	1	166460

enthaltend/containing			
Stck. pcs.	Artikel/article	No.	Maße/size
je 5 each		4515 C	T6 T7 T8 T9 T10 T15 T20 T25 T27 T30 T40

4500



4500-100

Verkaufsständer für 2K Schraubendreher, leer
Display stands for 2K Screwdriver, empty
Présentoirs pour tournevis 2K, vide
Expositor de destornilladores 2K, vacío

Code	No.	für/for			EAN
04500010000	4500-100	4500 4501 4502	1510	1	166408

4511

DIN 5262 / ISO 8764-2



Kreuzschlitz-Schraubendreher für PHILLIPS-RECESS-Schrauben

Molybdän-Vanadium / • Chrom-Vanadium, C = verchromt (mit schwarzer Spitze), mit 2K Kunststoffheft, No. 3+4 = Sechskantklinge mit Schlüsselhilfe

Cross slot screwdrivers for cross slot screws PHILLIPS-RECESS

Molybdenum-Vanadium / • Chrome-Vanadium, C = chromium plated (with black tip), with 2K plastic handle, No. 3+4 = hexagon blade and additional bolster

Tournevis cruciforme pour vis PHILLIPS-RECESS

Molybdène-Vanadium / • Chrome-Vanadium, C = chromées (avec extrémité brunie), avec manche en plastique 2K, No. 3+4 = lame hexagonale avec adaptateur de clé de serrage

Destornillador de punta cruciforme para tornillos PHILLIPS-RECESS

Molibdeno Vanadio / • Cromo Vanadio, C = varilla cromada con punta pavonada, mango de plástico 2K, No. 3+4 = varilla exagonal con exágono forjado

Code	No.	L ₁ mm	L ₂ mm	mm	g		EAN
04511000180	01	25	85	—	35	10	165586
04511000280	02	25	85	—	38	10	165579
04511000080	0	60	140	—	45	10	165562
04511001080	1	75	165	—	50	10	165555
04511002080	2	100	200	—	80	10	165548
04511003080	• 3	150	260	8/13	160	5	165531
04511004080	• 4	200	310	10/16	210	5	165593

4511-01 + 02



4511-0 + 1 + 2



4511-3 + 4

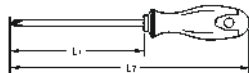

4512

DIN 5262 / ISO 8764-2



Kreuzschlitz-Schraubendreher für POZIDRIV®-Schrauben

Molybdän-Vanadium / • Chrom-Vanadium, C = verchromt (mit schwarzer Spitze), mit 2K Kunststoffheft, No. 3 = Sechskantklinge mit Schlüsselhilfe

Cross slot screwdrivers for cross slot screws POZIDRIV®

Molybdenum-Vanadium / • Chrome-Vanadium, C = chromium plated (with black tip), with 2K plastic handle, No. 3 = hexagon blade and additional bolster

Tournevis cruciforme pour vis POZIDRIV®

Molybdène-Vanadium / • Chrome-Vanadium, C = chromées (avec extrémité brunie), avec manche en plastique 2K, No. 3 = lame hexagonale avec adaptateur de clé de serrage

Destornillador de punta cruiforme para tornillos POZIDRIV®

Molibdeno Vanadio / • Cromo Vanadio, C = varilla cromada con punta pavonada, mango de plástico 2K, No. 3 = varilla exagonal con exágono forjado

Code	No.	L ₁ mm	L ₂ mm	mm	g		EAN
04512000180	01	25	85	—	35	10	165821
04512000280	02	25	85	—	38	10	165814
04512001080	1	75	165	—	50	10	165791
04512002080	2	100	200	—	80	10	165784
04512003080	• 3	150	260	8/13	160	5	165777

4512-01 + 02



4512-0 + 1 + 2



4512-3

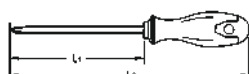

4515

Schraubendreher für Innen-TORX®-Schrauben

Molybdän-Vanadium, C = verchromt (mit schwarzer Spitze)
mit 2K Kunststoffheft

TORX®-Screwdrivers for TORX®-Socket screws

Molybdenum-Vanadium, C = chromium plated (with black tip)
with 2K plastic handle

Tournevis pour vis TORX® intérieures

Molybdène-Vanadium, C = chromées (avec extrémité brunie)
avec manche en plastique 2K

Destornillador para tornillos TORX®

Molibdeno Vanadio, C = varilla cromada con punta pavonada,
mango de plástico 2K



Code	Größe size	★ mm	L ₁ mm	L ₂ mm	g		EAN
04515000680	T 6	1,67	60	130	27	10	165760
04515000780	T 7	1,99	60	140	27	10	165753
04515000880	T 8	2,31	60	140	29	10	165746
04515000980	T 9	2,50	60	140	29	10	165739
04515001080	T 10	2,74	100	180	45	10	165722
04515001580	T 15	3,27	100	190	45	10	165715
04515002080	T 20	3,86	100	200	70	10	165708
04515002580	T 25	4,43	100	200	70	10	165692
04515002780	T 27	4,99	100	200	70	10	165685
04515003080	T 30	5,52	115	225	100	5	165678
04515004080	T 40	6,65	125	235	145	5	165661

4530

DIN 5265 / ISO 2380-2

Werkstatt-Schraubendreher für Schlitzschrauben

Chrom-Vanadium, C = verchromt (mit schwarzer Spitze)
mit 2K Kunststoffheft

Engineers' screwdrivers for plain slot screws

Chrome-Vanadium, C = chromium plated (with black tip)
with 2K plastic handle

Tournevis d'atelier pour vis à fente

Chrome-Vanadium, C = chromées (avec extrémité brunie)
avec manche en plastique 2K

Destornillador de mecánico de punta plana

Cromo Vanadio, C = varilla cromada con punta pavonada
mango de plástico 2K

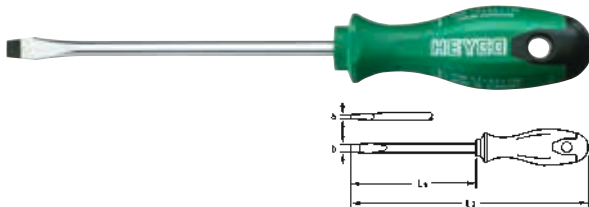

Code	a mm	b mm	L ₁ mm	L ₂ mm	g		EAN
04530010080	1,0	5,5	100	200	100	10	165470
04530012580	1,2	6,5	125	225	125	10	165463
04530015080	1,2	8,0	150	260	190	10	165456
04530020080	1,6	10,0	200	310	200	5	165449
04530025080	2,0	12,0	250	360	280	5	165432
04530030080	2,5	14,0	300	410	300	5	165425

4535

Elektriker-Schraubendreher für Schlitzschrauben

Chrom-Vanadium, C = verchromt (mit schwarzer Spitze)
mit 2K Kunststoffheft

Electricians' screwdrivers for plain slot screws

Chrome-Vanadium, C = chromium plated (with black tip)
with 2K plastic handle

Tournevis d'électricien pour vis à fente

Chrome-Vanadium, C = chromées (avec extrémité brunie)
avec manche en plastique 2K

Destornillador de electricista punta plana

Cromo Vanadio, C = varilla cromada con punta pavonada
mango de plástico 2K



Code	a mm	b mm	L ₁ mm	L ₂ mm	g		EAN
04535006080	0,4	2,5	60	130	27	10	165302
04535007580	0,5	3,0	75	155	30	10	165319
04535010080	0,5	3,5	100	180	45	10	165326
04535012580	0,8	4,0	125	215	58	10	165333
04535015080	0,8	5,0	150	250	76	10	165340
04535020080	0,8	5,0	200	300	85	10	165357

4537

Werkstatt-Schraubendreher für Schlitzschrauben

Chrom-Vanadium, C = verchromt (mit schwarzer Spitze)
mit Sechskantklinge und Schlüsselhilfe und 2K Kunststoffheft

Engineers' screwdrivers for plain slot screws

Chrome-Vanadium, C = chromium plated (with black tip)
with hexagon blade and additional bolster and 2K plastic handle

Tournevis d'atelier pour vis à fente

Chrom-Vanadium, C = chromées (avec extrémité brunie)
avec lame hexagonale et adaptateur de clé de serrage et manche en plastique 2K

Destornillador de mecánico de punta plana

Cromo Vanadio, C = varilla cromada con punta pavonada,
perfil exagonal con exágono forjado, mango de plástico 2K

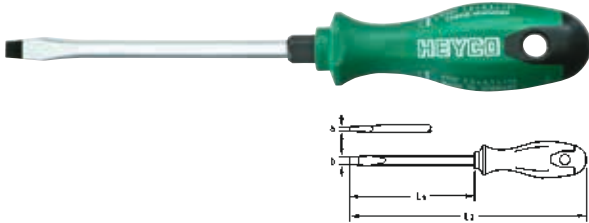

Code	a mm	b mm	L ₁ mm	L ₂ mm	mm	g	g	EAN
04537010080	1,0	5,5	100	200	5/8	74	10	165371
04537012580	1,2	6,5	125	225	6,35/10	100	10	165388
04537015080	1,2	8,0	150	260	8/13	160	10	165395
04537017580	1,6	10,0	175	285	10/16	220	10	165401
04537020080	2,0	12,0	200	310	10/16	250	5	165418
04537025080	2,5	14,0	250	360	10/16	285	5	165364

4545

Vergaser-Schraubendreher für Schlitzschrauben

Chrom-Vanadium, C = verchromt (mit schwarzer Spitze)
mit 2K Kunststoffheft

Stubby screwdrivers for plain slot screws

Chrom-Vanadium, C = chromium plated (with black tip)
with 2K plastic handle

Tournevis boule pour vis à fente

Chrom-Vanadium, C = chromées (avec extrémité brunie)
avec manche en plastique 2K

Destornillador corto punta plana

Cromo Vanadio, C = varilla cromada con punta pavonada
mango de plástico 2K

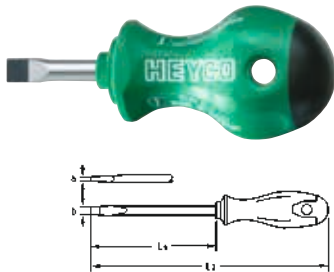

Code	a mm	b mm	L ₁ mm	L ₂ mm	g	g	EAN
04545004080	0,8	4,0	25	85	35	10	165494

3301-1

Magnet-Bithalter

zur Aufnahme von Bits mit Außensechskant 1/4", Klinge verchromt,
mit 2-K Kunststoffheft

Magnetic bitholder

for bits 1/4"-drive, chromium plated,
with 2-K plastic handle

Adaptateur magnétique

pour embots 1/4", couteau chromatisé,
avec manche à 2 composantes

Soporte imantado para puntas de destornillador

Para acoplamiento de puntas con hexágono exterior de 1/4",
hoja cromada, mango de plástico de dos componentes

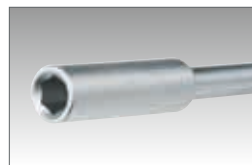

Code	No.	mm	g	g	EAN
03301010080	3301-1	200	102	10	366204

4560

Schraubendreher-Satz für Innen-TORX®-Schrauben
Screwdriver set for TORX®-Socket screws
Jeux de tournevis pour vis TORX® intérieures
Conjunto de destornilladores para tornillos TORX®



Code	tlg./pcs.			EAN
04560000080	6	600	1	167702

enthaltend/containing			
Stck. pcs.	Artikel/article	No.	Maße/size
je 1 each		4515 C	T 10 T 15 T 20 T 25 T 30 T 40

4561 - 4563

Schraubendreher-Sätze für Schlitzschrauben
Screwdriver sets for plain slot screws
Jeux de tournevis pour vis à fente
Conjunto de destornilladores para tornillos ranurados



Code	No.	tlg./pcs.			EAN
04561000080	4561	7	383	1	359107

enthaltend/containing			
Stck. pcs.	Artikel/article	No.	Maße/size
je 1 each		4535 C	60 x 2,5 x 0,4 75 x 3 x 0,5 100 x 3,5 x 0,5 125 x 4 x 0,8 150 x 5 x 0,8 mm
je 1 each		4545 C	25 x 4 mm
je 1 each		4511 C	25 mm x PH 01

Code	No.	tlg./pcs.			EAN
04562000080	4562	6	689	1	359114

enthaltend/containing			
Stck. pcs.	Artikel/article	No.	Maße/size
je 1 each		4537 C	100 x 5,5 x 1 125 x 6,5 x 1,2 150 x 8 x 1,2 175 x 10 x 1,6 mm
je 1 each		4545 C	25 x 4 mm
je 1 each		4511 C	25 mm x PH 01

Code	No.	tlg./pcs.			EAN
04563000080	4563	6	482	1	359121

enthaltend/containing			
Stck. pcs.	Artikel/article	No.	Maße/size
je 1 each		4530 C	100 x 5,5 x 1 125 x 6,5 x 1,2 150 x 8 x 1,2 mm
je 1 each		4535 C	75 x 3 x 0,5 mm
je 1 each		4545 C	25 x 4 mm
je 1 each		4511 C	25 mm x PH 01

4564 - 4567

Schraubendreher-Sätze

Screwdriver sets

Jeux de tournevis

Conjuntos de destornilladores



4564



4565



4567

NEU
NEW



4568

Code	No.	tlg./pcs.			EAN
04564000080	4564	7	700	1	166507

enthaltend/containing

Stck. pcs.	Artikel/article	No.	Maße/size
je 1 each		4530 C	6,5 x 125 8 x 150 mm
je 1 each		4535 C	2,5 x 60 3 x 75 5 x 150 mm
je 1 each		4512 C	PZ No. 1 2

Code	No.	tlg./pcs.			EAN
04565000080*	4565	7	700	1	166514

wie 4564, jedoch/as 4564, but

Stck. pcs.	Artikel/article	No.	Maße/size
je 1 each		4511 C	PH No. 1 2

Code	No.	tlg./pcs.			EAN
04566000080	4566	6	510	1	359138

enthaltend/containing

Stck. pcs.	Artikel/article	No.	Maße/size
je 1 each		4511 C	PH No. 01 02 0 1 2 3

Code	No.	tlg./pcs.			EAN
04567000080	4567	5	615	1	166491

enthaltend/containing

Stck. pcs.	Artikel/article	No.	Maße/size
je 1 each		4537 C	5,5 x 100 6,5 x 125 8 x 150 mm
1		4512 C	PZ No. 2
1		4511 C	PH No. 2

Code	No.	tlg./pcs.			EAN
04568000080	4568	7	645	1	457810

enthaltend/containing

Stck. pcs.	Artikel/article	No.	Maße/size
je 1 each		4530 C	5,5 x 100 6,5 x 125 8 x 150 mm
je 1 each		4512 CV	PZ No. 1 2
je 1 each		4511 C	PH No. 1 2

SICHERHEITSWERKZEUGE

INSULATED SAFETY TOOLS



1000 Volt / DIN EN 60900 (VDE 0682, Teil 201)
1000 Volt / DIN EN 60900 (VDE 0682, part 201)

4511

DIN 7438



VDE Kreuzschlitz-Schraubendreher für PHILLIPS-RECESS-Schrauben

Molybdän-Vanadium, BV = brüniert, schutzisoliert gemäß DIN EN 60900 mit eingespritzt ummantelter Klinge, mit 2K Kunststoffheft

VDE Cross slot screw-drivers for cross slot screws PHILLIPS-RECESS



Molybdenum-Vanadium, BV = burnished, VDE 1000 volt insulated, complying with DIN EN 60900, insulation of blade and handle injection moulded as one unit, with 2K plastic handle

VDE Tournevis cruciforme pour vis PHILLIPS-RECESS

Molybdène-Vanadium, BV = brunis, isolés conformément aux spécifications DIN EN 60900, isolation de la lame par injection, avec manche en plastique 2K

VDE Destornillador cruciforme para tornillos PHILLIPS-RECESS

Molibdeno Vanadio, BV = varilla pavonada, aislamiento de seguridad según DIN EN 60900, varilla con aislamiento inyectado, mango de plástico 2K

Code	No.	L ₁ mm	L ₂ mm	 g		EAN
04511001033	1	80	185	50	10	165524
04511002033	2	100	210	80	10	165517

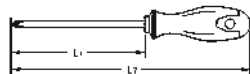
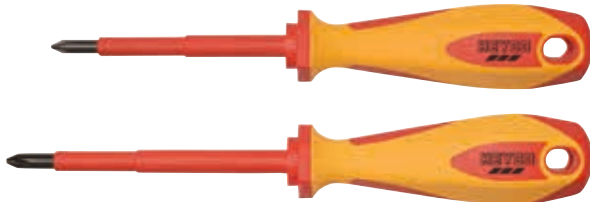

4536

DIN 7437



VDE Elektriker-Schraubendreher für Schlitzschrauben

Chrom-Vanadium, BV = brüniert, schutzisoliert gemäß DIN EN 60900 mit eingespritzt ummantelter Klinge, mit 2K Kunststoffheft

VDE Electricians' screwdrivers for plain slot screws

Chrome-Vanadium, BV = burnished, VDE 1000 volt insulated complying with DIN EN 60900, insulation of blade and handle injection moulded as one unit, with 2K plastic handle

VDE Tournevis d'électricien pour vis à fente

Chrom-Vanadium, BV = brunis, isolés conformément aux spécifications DIN EN 60900, isolation de la lame par injection, avec manche en plastique 2K

VDE Destornillador de electricista punta plana

Cromo Vanadio, BV = varilla pavonada, aislamiento de seguridad según DIN EN 60900, varilla con aislamiento inyectado, mango de plástico 2K

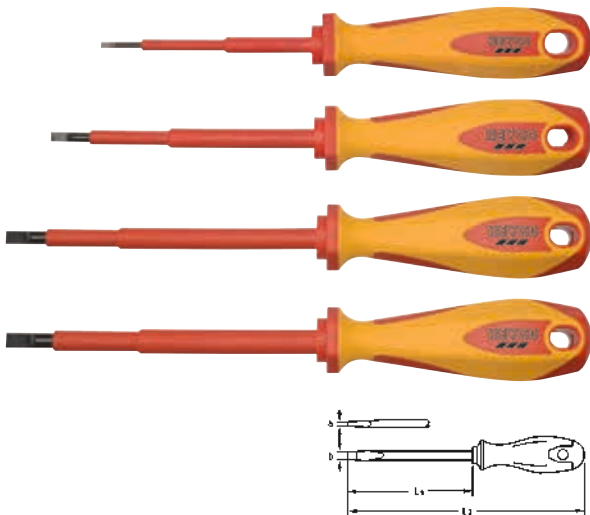

Code	a mm	b mm	L ₁ mm	L ₂ mm			EAN
04536007533	0,4	2,5	75	145	23	10	165289
04536010133	0,8	4,0	100	180	44	10	165265
04536012533	1,0	5,5	125	215	70	5	165258
04536015033	1,2	6,5	150	250	85	5	165241

4550

VDE Schraubendreher-Satz

VDE Screwdriver set

VDE Jeux de tournevis

VDE Conjunto de destornilladores



Code	No.	tlg./pcs.			EAN
04550000033	4550 VDE	7	630	1	166521

enthaltend/containing

Stck. pcs.	Artikel/article	No.	Maße/size
je 1 each		4536 VDE	2,5 x 75 4 x 100 5,5 x 125 6,5 x 150 mm
1		1427 VDE	3 x 65 mm
je 1 each		4511 VDE	PH No. 1 2

Achtung Designänderung, Abbildung ähnlich.

ALLGEMEINER WERKSTATTBEDARF
KFZ-WERKZEUGE

OTHER PRODUCTS FOR WORKSHOPS
AUTOMOBILE TOOLS





1500

Reifen- und Montagehebel

Chrom-Vanadium, C = verchromt, profiliert gesenkgeschmiedet

Tyre levers

Chrome-Vanadium, C = chromium plated, profiled drop forged, straight

Démonte-pneus

Chrome-Vanadium, C = chromées, acier profilé forgé, forme droite

Desmontables

Cromo Vanadio, C = cromado, perfil forjado, rectos



Code	←L→		mm	g	mm	EAN
	mm	"				
01500030080	300	12	22 x 7,0	195	10	029383
01500040080	400	16	25 x 7,5	380	10	029406
01500050080	500	20	27 x 9,0	645	10	029413
01500060080	600	24	27 x 11,0	920	10	029420

1505

Reifen- und Montagehebel

Chrom-Vanadium, C = verchromt, profiliert gesenkgeschmiedet

Tyre levers

Chrome-Vanadium, C = chromium plated, profiled drop forged, straight

Démonte-pneus

Chrome-Vanadium, C = chromées, acier profilé forgé, forme droite

Desmontables

Cromo Vanadio, C = cromado, perfil forjado, rectos



Code	←L→		mm	g	mm	EAN
	mm	"				
01505040080	400	16	25 x 7,5	350	10	029437
01505050080	500	20	28 x 8,6	520	10	029444
01505060080	600	24	28 x 8,6	730	10	029451

1509

Reifen- und Montagehebel

L = lackiert

Tyre levers

L = lacquered

Démonte-pneus

L = laquées

Desmontables

L = barnizado



Code	Mercedes-Benz No.	←L→		g	mm	EAN
		mm	"			
01509045020	0005811758	450	18	760	5	029468
01509060020	0005812158	600	24	1530	1	029475

1577

Zimmermanns-Nageleisen

L = lackiert

Goose neck ripping bars

L = lacquered

Pince à décoffrer

L = laquées

Palanca para albañiles

L = barnizado



Code	No.	←L→		mm	g	mm	EAN
		mm	"				
01577040000	1577-400	400	17	860	5	387001	
01577050000	1577-500	500	17	1080	5	387018	
01577060000	1577-600	600	17	1300	5	387025	
01577080000	1577-800	800	19	2120	5	387032	
01577100000	1577-1000	1000	19	2600	5	387049	

103

Spezial-Hebeleisen

Chrom-Vanadium, C = verchromt, profiliert gesenkgeschmiedet

Special pry bars

Chrome-Vanadium, C = chromium plated, profiled drop forged

Barres de levier spéciales

Chrome-Vanadium, C = chromées, forgée profilée

Palanca especial

Cromo Vanadio, C = cromado, perfil forjado



Code	No.	←L→		g	mm	EAN
		mm	"			
50210340800	103	400	14	480	5	056532

113

Hebeleisen

Chrom-Vanadium, C = verchromt, profiliert gesenkgeschmiedet

Pry bars

Chrome-Vanadium, C = chromium plated, profiled drop forged

Barres de levier

Chrome-Vanadium, C = chromées, forgée profilée

Palanca

Cromo Vanadio, C = cromado, perfil forjado



Code	No.	←L→ mm	● mm	g	5	EAN
50211340800	113	400	14	500	5	056624

1512

Kunststoffschaber

Glasfaserverstärkt

Plastic scraper

Glass fibre reinforced

Grattoir plastique

Renforcé fibre de verre

Rascador de plástico

Reforzado con fibra de vidrio



Code	←L→ mm	g	5	EAN
91512028000	280	110	5	327120

1513

Reifen-Montierwerkzeug

- Hergestellt aus Polyamide, glasfaserverstärkt
- Das hochwertige Material verspricht absoluten Schutz vor Beschädigungen an Aluminium und lackierten Felgen
- Mehr Kontaktfläche an Felge und Reifen
- Optimale Handhabung durch Handgriff

Tyre change presser

- Polyamide, fiberglass-reinforced
- The high grade material grants full protection against damages of aluminium and coated rims
- More contact surface to the rim and tire
- Optimum handling through handle

Outil montage de pneu

- Le matériel de haute qualité
- Le matériel de haute qualité promet une protection absolue contre les dégâts à l'aluminium et les jantes peintes
- Plus de contact sur la jante et le pneu
- Prise en main optimale du manche

Herramienta para montar neumáticos

- De poliamida reforzada por fibra de vidrio
- El material de alta calidad otorga una perfecta protección contra daños en llantas de aluminio o pintadas
- Mayor superficie de contacto en llanta y neumático
- Manejo óptimo gracias a su asa



Code	←L→ mm	g	1	EAN
01513000000	290 x 150	110	1	375732

1520

DIN 1041

Schlosserhämmer

LS = lackiert

Bahn und Pinne geschliffen, deutsche Form, doppeltgeschweifert Eschenstiel nach DIN 5111, kunststoffversiegelt.

Engineers' hammers

LS = lacquered

Polished face and pein, German pattern, with curved ash handle to DIN 5111, sealed with plastic.

Marteaux de mécanicien

LS = laquées



Panne et face meulées, modèle allemand, manche en frêne selon DIN 5111, scellement plastique.

Martillos de peña

LS = barnizado

Cara y peña amoladas, modelo alemán, mango de madera de fresno según DIN 5111, enmangado con remate de plástico.



Code	 g	L ₁ mm	L ₂ mm	 g		EAN	
01520020021	200	95	280	265	6	029499	
01520030021	300	105	300	380	6	029505	
01520050021	500	118	325	615	6	029529	
01520080021	800	130	350	1000	6	029536	
01520100021	1000	135	360	1135	6	029543	
01520200021	2000	155	400	2375	1	029567	
01520300021	3000	165	600	3230	1	454505	36,00

Schlagschutzhülse für 1000 & 2000 Gr.

Impact protection sleeve for 1000 & 2000 Gr.

1522

Schlosserhämmer

AS = schwarz

Bahn und Pinne geschliffen, englische Form, Kugelpinne, Eschenstiel.

Engineers' ball pein hammers

AS = black

Polished face and pein, English pattern, ball pein, ash handle.

Marteaux de mécanicien

AS = noirs



Panne et face meulées, modèle anglais, panne bombée, manche en frêne.

Martillos de bola

AS = barnizado en negro

Frente y bola amoladas, modelo inglés, mango de madera de fresno.



Code	 lbs.	L ₁ mm	L ₂ mm	 g		EAN	
01522050011	1/2	80	300	315	6	029581	
01522075011	3/4	88	330	420	6	029598	
01522100011	1	100	355	550	6	029604	
01522150011	1.1/2	112	380	815	6	029628	
01522200011	2	121	400	1135	6	029635	

1523

Kupferhammer

mit Eschenstiel

Copper hammer

with ash handle

Marteau cuivre

manche fêne

Martillo de cobre

con mango de madera de fresno



Code	 g	 g		EAN
01523075000	750	780	1	385939

1530

Rückschlagfreie Nylonhämmer

ST = standardmäßig
Gehäuse mit Stahlschrot gefüllt – durch Gewichtsverlagerung beim Auftreffen optimale, rückprallfreie Schlagwirkung, auswechselbare Nylonköpfe, Hickory-Stiel.

“Dead Blow“ nylon hammers

ST = standard
Housing is partially filled with steel shot, which adds to the weight, prevents rebound and provides “dead blows” of maximum impact, replaceable nylon heads, hickory handle.

Massettes à embouts nylon, sans rebond

ST = standard
Le corps est rempli par de la grenaille – lors du choc, le mouvement de cette grenaille dans la cavité du corps élimine le rebond des marteaux, embouts de nylon interchangeable, manche hickory.

Martillos con bocas de nylon, sin rebote

ST = estándar
Cabeza con relleno de granalla, cuyo desplazamiento al golpear amortigua el rebote, bocas de nylon intercambiables, mango de madera de hickory

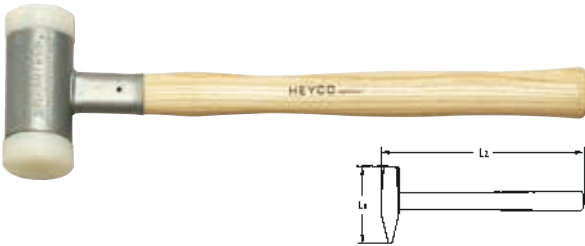

Code	Ø mm	L ₁ mm	L ₂ mm	g	Icon	EAN
01530003000	30	110	330	440	2	029697
01530003500	35	110	330	545	2	029703
01530004000	40	115	355	745	2	029710
01530005000	50	120	365	1030	2	029734

1531

Nylon-Ersatzköpfe

ST = standardmäßig
für rückschlagfreie Hämmer HEYCO 1530

Spare nylon heads

ST = standard
for “dead blow” hammers HEYCO 1530

Embouts de nylon interchangeables

ST = standard
pour massettes sans rebond HEYCO 1530

Bocas de nylon, de recambio

ST = estándar
para martillos sin rebote HEYCO 1530



Code	Ø mm	g	Icon	EAN
01531003000	30	17	10	029765
01531003500	35	23	10	029772
01531004000	40	33	10	029789
01531005000	50	55	10	029802

Weitere Kunststoffhämmer und entsprechende Ersatzköpfe finden Sie unter
Further plastic hammers and spare heads can be found under
Pour d'autres modèles et embouts de rechange: voir les références
Para otros modelos de martillos con bocas de plástico y sus recambios, véase
HEYCO 2165 – 2166

1540-1

DIN 5128 A

Gummihämmer

ST = standardmäßig
Zwei gerade Flächen, Eschenstiel.

Rubber mallets

ST = standard
Two flat faces, ash handle.

Maillets caoutchouc

ST = standard
Deux faces plates, manche en frêne.

Mazos de goma

ST = estándar
Dos bocas planas, mango de madera de fresno.



Code	Ø mm	L ₁ mm	L ₂ mm	g	Icon	EAN
01540000100	54	90	320	330	1	029833
01540000400	90	140	380	1200	1	382693

2165

Kunststoff-Hämmer

ST = standardmäßig, Eschen-Stiel, auswechselbare Köpfe aus transparentem Kunststoff (Celluloseacetat)

Plastic hammers

ST = standard, Ash handle, exchangeable heads made of transparent plastic (cellulose acetate)

Massettes avec embouts en plastique

ST = standard, Manche en bois tropical (Amazonas) embouts interchangeables en plastique transparent (acétocellulose)

Martillos con bocas de plástico

ST = estándar, Mango de madera de fresno, bocas intercambiables de plástico transparente (acetato de celulosa)

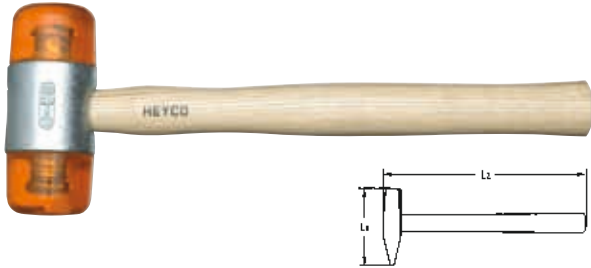

Code	Kopf/head-Ø mm	L ₁ mm	L ₂ mm	g		EAN
02165003200	32	90	285	305	2	033236
02165003500	35	100	300	390	2	033243
02165004000	40	105	320	545	2	033250
02165005000	50	115	340	865	2	033267

2166

Ersatzköpfe

ST = standardmäßig, aus transparentem Kunststoff (Celluloseacetat) für Kunststoff-Hämmer HEYCO 2165

Spare heads

ST = standard, made of transparent plastic (cellulose acetate) for plastic hammers HEYCO 2165

Embouts de rechange

ST = standard, en plastique transparent (acétocellulose) pour massettes HEYCO 2165

Bocas de recambio

ST = estándar, de plástico transparente (acetato de celulosa) para martillos con bocas de plástico HEYCO 2165



Code	Kopf/head-Ø mm	g		EAN
02166003200	32	21	10	033304
02166003500	35	23	10	033311
02166004000	40	37	10	033328
02166005000	50	67	10	033335

CHROM-VANADIUM MIT SICHERHEITSSCHLAGKOPF

CHROME-VANADIUM WITH NON-SPREADING SAFETY HEAD

DIN

1550 - 1551

Werkzeugsätze mit

Meißeln, Körnern, Splint- und Durchtreibern, 6-tlg.

Chrom-Vanadium, LS = lackiert, Spitzen und Schneiden geschliffen, achtkantige Form, Lufthärtestahl, Sicherheits-Schlagköpfe
1550 im Holzständer, 1551 in klappbarer Metallkassette

Chisel and punch sets, 6 pcs.

Chrome-Vanadium, LS = lacquered, ground points and blades octagonal shape, air hardening steel, non-spreading safety heads
1550 in wooden bench stand
1551 in hinged metal box

Compositions de

burins, bédanes et chasse-clous, 6 pcs.

Chrome-Vanadium, LS = laquées, tiges et tranchants/taillants meulés modèle octogonal, acier autotrempeant, tête traitée pour éviter le champignonage
1550 en présentoir de bois
1551 en boîte métallique, repliable

Conjuntos de herramientas compuestas de

cortafrios, buriles, granetes y punzones cónico 6 pzs.

Cromo Vanadio, LS = barnizado, puntas y cortantes amolados, mango octogonal, acero autotemplante, cabezas con revenido especial
1550 en expositor de madera
1551 en caja metálica plegable

Code	No.	enthaltend/containing					EAN
		Stück./pcs.	No.	Maße/dimensions			
0155000021	1550	1	1555 spezial/special	125 x 10	585	2	029888
		1	1555 spezial/special	150 x 15			
		1	1560 spezial/special	125 x 4			
		1	1570	120 x 3			
		1	1570	150 x 4			
		1	1575	120 x 4			
01551000021	1551	Inhalt wie vor/contents as above			845	1	029895

1550



1551



1555 – 1555-1

DIN 6453

Flachmeißel mit Sicherheitsschlagkopf

Chrom-Vanadium

1555, LS = lackiert, Blatt und Schneide, geschliffen

1555-1, ST = standardmäßig mit Handschutzgriff

(Meißel – lackiert, Blatt und Schneide geschliffen,

Handschutzgriff – Kunststoff, schwarz)

flach-ovale Form, Lufthärtetestahl, Sicherheits-Schlagköpfe

Flat cold chisel with non-spreading safety head

Chrome-Vanadium

1555, LS = lacquered, ground blade and cutting edge

1555-1, ST = standard, with hand guard

(chisel – lacquered, ground blade and cutting edge,

hand guard – plastic, black)

flat-oval shape, air-hardening steel, non-spreading safety head

Burins de mécanicien avec tête de sécurité

Chrome-Vanadium

1555, LS = laquées, tranchant et taillant meulés

1555-1, ST = standard avec protecteur

(burin – laqué, tranchant et taillant meulés,

protecteur – plastique noir), modèle plat-oval, acier autotremplant,

tête traitée pour éviter le champignonage

Cortafrios con cabeza de seguridad

Cromo Vanadio

1555, LS = barnizado, boca y cortante amolados

1555-1, ST = estándar, con salvamanos

(mango – barnizado, boca y cortante,

amolados salvamanos – plástico negro)

mango ovalado-plano, acero autotemplante, cabezas

con revenido especial

Code	No.	←L→ mm		A mm	B mm	C mm	g	g	EAN
01555012521	1555	125	5	16	14	9	105	5	029932
01555015021	1555	150	6	18	17	11	180	5	029949
01555017521	1555	175	7	22	20	12	270	5	029963
01555020021	1555	200	8	25	23	13	385	5	029970
01555025021	1555	250	10	25	23	13	495	5	029987
01555030021	1555	300	12	26	23	13	610	5	029994
*01555125000	1555-1	250	10	25	23	13	595	5	030006

*1555-1 mit Handschutz / with hand guard

1555



1555-1

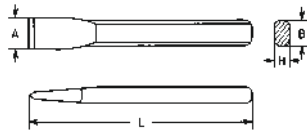

1556

DIN 7254

Steinmeißel mit Sicherheitsschlagkopf

Chrom Vanadium

Stone chisel with non-spreading safety head

Chrome-Vanadium

Burin avec tête de sécurité

Chrome-Vanadium

Cinzel para canteros con cabeza de seguridad

Cromo Vanadio



Code	←L→ mm	mm	mm	g	g	EAN
01556012521	125	10	12	80	10	386677
01556015021	150	12	16	120	10	386714
01556017521	175	14	20	260	10	386721
01556020021	200	16	22	300	10	386738

1557 – 1557-1

Schlitzmeißel mit Sicherheitsschlagkopf

Chrom Vanadium, LS = lackiert, Blatt und Schneide geschliffen

Jointing chisel with non-spreading safety head

Chrome-Vanadium, LS = lacquered, ground blade and cutting edge

Burin à fendre avec tête de sécurité

Chrome-Vanadium, LS = laquées, tranchant et taillant meulés

Cinzel extraplano con cabeza de seguridad

Cromo Vanadio, LS = barnizado, boca y cortante amolados

Code	No.	←L→ mm	mm	mm	g	g	EAN
01557023021	1557	230	26 x 7	26	300	10	030020
*01557123000	1557-1	230	26 x 7	26	420	5	030037

*1557-1 mit Handschutz / with hand guard

1557



1557-1



1558 - 1558-1

Fugenmeißel mit Sicherheitsschlagkopf

Chrom Vanadium, LS = lackiert, Blatt und Schneide geschliffen

Grooving chisel with non-spreading safety head

Chrome-Vanadium, LS = lacquered, ground blade and cutting edge

Burin plat avec tête de sécurité

Chromée-Vanadium, LS = laquées, tranchant et taillant meulés

Cinzel para juntas con cabeza de seguridad

Cromo Vanadio, LS = barnizado, boca y cortante amolados



Code	No.	←L→ mm	mm mm	mm mm	g	g	EAN
01558250021	1558	250	23 x 13	50	500	5	386844
*01558125000	1558-1	250	23 x 13	50	600	5	030051

*1558-1 mit Handschutz / with hand guard

1560 - 1560-1

DIN 6451

Kreuzmeißel mit Sicherheitsschlagkopf

Chrom-Vanadium, LS = lackiert, Blatt und Schneide geschliffen, flach-ovale Form, Lufthärtestahl, Sicherheits-Schlagkopf

Cross cut chisels with non-spreading safety head

Chrome-Vanadium, LS = lacquered, ground blade and cutting edge, flat-oval shape, air-hardening steel, non-spreading safety head

Burin en croix avec tête de sécurité

Chromée-Vanadium, LS = laquées, tranchant et taillant meulés, modèle plat-ovale, acier autotremplant, tête traitée pour éviter le champignonage

Buril con cabeza de seguridad

Cromo Vanadio, LS = barnizado, boca y cortante amolados, mango ovalado-plano, acero autotemplante, cabezas con revenido especial



Code	No.	mm	←L→ "	g	g	EAN
01560012521	1560	125	6	80	5	030075
01560015021	1560	150	6	160	5	030082
01560017521	1560	175	7	240	5	030099
01560020021	1560	200	8	330	5	030105
01560025021	1560	250	6	360	5	030112
*01560125000	1560-1	250	6	560	5	386660

*1560-1 mit Handschutz / with hand guard

1561

DIN 6451

Kreuzmeißel mit Sicherheitsschlagkopf

Chrom-Vanadium, LS = lackiert, Blatt und Schneide geschliffen

Cross cut chisels with non-spreading safety head

Chrome-Vanadium, LS = lacquered, ground blade and cutting edge

Burin en croix avec tête de sécurité

Chromée-Vanadium, LS = laquées, tranchant et taillant meulés

Buril con cabeza de seguridad

Cromo Vanadio, LS = barnizado, boca y cortante amolados

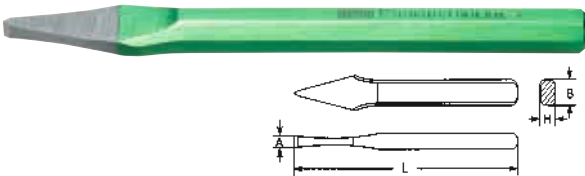

Code	←L→ mm	mm	mm	g	g	EAN
01561012521	125	10	5	80	10	386745
01561015021	150	12	6	120	10	386752
01561017521	175	16	8	220	10	386769
01561020021	200	16	9	260	10	386776

1563 - 1563-1

DIN 7254

Steinmeißel mit Sicherheitsschlagkopf

Chrom Vanadium, LS = lackiert, Blatt und Schneide geschliffen

Stone chisel with non-spreading safety head

Chrome-Vanadium, LS = lacquered, ground blade and cutting edge

Burin de maçon avec tête de sécurité

Chromée-Vanadium, LS = laquées, tranchant et taillant meulés

Cinzel de canteros con cabeza de seguridad

Cromo Vanadio

LS = barnizado, boca y cortante amolados



Code	No.	←L→ mm	mm mm	mm mm	g	g	EAN
01563020021	1563	200	20 x 12	26	320	10	386783
01563025021	1563	250	20 x 12	26	480	10	386790
01563030021	1563	300	23 x 13	32	600	10	386806
01563040021	1563	400	23 x 13	32	780	5	386813
*01563130000	1563	300	20 x 12	26	720	10	386820
*01563140000	1563-1	400	23 x 13	32	900	5	386837

*1563-1 mit Handschutz / with hand guard

1562-1

Handschutz

ST = standardmäßig (Kunststoff, schwarz) für Meißel HEYCO 1555 ab 250 mm Länge

Hand guards

ST = standard (plastic, black) for chisels HEYCO 1555 as from 250 mm

Protecteurs

ST = standard (plastique noir) pour HEYCO 1555 à partir d'une longueur de 250 mm

Salvamanos

ST = estándar (plástico negro) para cortafíos y buriles HEYCO 1555 a partir de 250 mm de largo



Code	für Meißel/for chisel			g	g	EAN
	No.	mm	Schaft/shaft-mm			
01562000100	1555	250	23 x 13	100	10	030150
	1555	300	23 x 13			

1564

DIN 6450 C

Splinttreiber mit Zapfen

Chrom-Vanadium

Parallel pin punch with pin

Chrome-Vanadium

Chasse-goupilles

Chrome-Vanadium

Punzones con pistón

Cromo Vanadio



Code	mm	Ø "	←L→ mm	MM	g	g	EAN

1565

DIN 6450 C

Splinttreiber

Chrom-Vanadium, LS = lackiert, Spitze geschliffen, achtkantige Form, Lufthärtestahl, Sicherheits-Schlagkopf.

Parallel pin punches

Chrome-Vanadium, LS = lacquered, ground point, octagonal shape, air-hardening steel, non-spreading safety head.

Chasse-goupilles

Chrome-Vanadium, LS = laquées, tige meulée, modèle octogonal, acier autotrempeant, tête traitée pour éviter le champignonage.

Punzones cilíndricos

Cromo Vanadio, LS = barnizado, punta amolada, mango octogonal, acero autotemplante, cabeza con revenido especial.



Code	mm	Ø "	←L→ mm	MM	g	g	EAN
01565000321	3	1/8	150	10	66	10	030181
01565000421	4	5/32	150	10	68	10	030198
01565000521	5	3/16	150	10	70	10	030211
01565000621	6	15/64	150	10	72	10	030228
01565000821	8	5/16	150	12	105	10	030235
01565001021	10	25/64	150	12	120	10	030242
01565001221	12	15/32	150	12	160	10	387247

1565-41

Splinttreiber

Chrom-Vanadium, LS = lackiert, Spitze geschliffen, achtkantige Form, Lufthärtestahl, Sicherheits-Schlagköpfe, lange Ausführung speziell für Sicherungsstifte der Scheibenbremsbeläge.

Parallel pin punch

Chrome-Vanadium, LS = lacquered, ground point, octagonal shape, air-hardening steel, non-spreading safety head, long type particularly for locking pins for pads of disc brakes.

Chasse-goupilles

Chrome-Vanadium, LS = laquées, tige meulée, tête traitée pour éviter le champignonage, modèle extra-long, speciaux pour les goupilles de sécurité de plaquettes de frein à disque.

Punzones cilíndricos

Cromo Vanadio, LS = barnizado, punta amolada, mango octogonal, acero autotemplante, cabeza con revenido especial, modelo largo, especial para bulones de ferodos de freno.



Code	Ø mm	←L→ mm	MM	g	g	EAN

1566 - 1567

Werkzeugsätze mit Splinttreibern, 6-tlg.

Chrom-Vanadium, LS = lackiert, Spitzen geschliffen, achtkantige Form, Lufthärtestahl, Sicherheits-Schlagköpfe.

Parallel pin punch sets, 6 pcs.

Chrome-Vanadium, LS = lacquered, ground points, octagonal shape, air-hardening steel, non-spreading safety heads.

Compositions de chasse-goupilles, 6 pcs.

Chrome-Vanadium, LS = laquées, tige meulée, modèle octogonal, acier autotrempeant, tête traitée pour éviter le champignonage.

Juegos de punzones cilindricos, 6 pzs.

Cromo Vanadio, LS = barnizado, punta amolada, mango octogonal, acero autotemplante, cabeza con revenido especial.

Code	No.	enthaltend/containing			g	EAN	
		Stck./pcs.	No.	Maße/dimensions			
01566000021	1566	je 1 each	1565	150 x 10 x 3	565	2	030273
				150 x 10 x 4			
				150 x 10 x 5			
				150 x 10 x 6			
				150 x 12 x 7			
150 x 12 x 8							
01567000021	1567	Inhalt wie vor/contents as above			800	1	030280

1566



1567



1566 im Holzständer,
1567 in klappbarer Metallkassette
1566 in wooden bench stand,
1567 in hinged metal box

1570

DIN 6458 D

Durchschläger mit Sicherheitsschlagkopf

Chrom-Vanadium, LS = lackiert, Spitze geschliffen, achtkantige Form, Lufthärtestahl, Sicherheits-Schlagkopf.

Taper pin punch with non-spreading safety head

Chrome-Vanadium, LS = lacquered, ground point, octagonal shape, air-hardening steel, non-spreading safety head.

Chasse-clous avec tête de sécurité

Chrome-Vanadium, LS = laquées, tige meulée, modèle octogonal, acier autotrempeant, tête traitée pour éviter le champignonage.

Punzones cónicos con cabeza de seguridad

Cromo Vanadio, LS = barnizado, punta amolada, mango octogonal, acero autotemplante, cabeza con revenido especial.

Code	Ø		←L→ mm	MM	g	EAN	
	mm	"					
01570000221	2	5/64	120	12	88	10	030310
01570000321	3	1/8	120	12	89	10	030327
01570000421	4	5/32	120	12	91	10	030334
01570000521	5	3/16	120	12	92	10	030341
01570000621	6	15/64	120	12	94	10	030358
01570000821	8	5/16	120	12	100	10	030365
01570001021	10	25/64	150	12	130	10	030372
01570001221	12	15/32	150	14	180	10	387216
01570001421	14	9/16	175	16	280	10	387223
01570001621	16	5/8	175	18	360	10	387230



1575

DIN 7250

Körner mit Sicherheitsschlagkopf

Chrom-Vanadium, LS = lackiert, Spitze geschliffen, achtkantige Form, Lufthärtestahl, Sicherheits-Schlagkopf.

Center punch with non-spreading safety head

Chrome-Vanadium, LS = lacquered, ground point, octagonal shape, air-hardening steel, non-spreading safety head.

Pointeaux avec tête de sécurité

Chrome-Vanadium, LS = laquées, tige meulée, modèle octogonal, acier autotrempeant, tête traitée pour éviter le champignonage.

Granetes

Cromo Vanadio, LS = barnizado, punta amolada, mango octogonal, acero autotemplante, cabeza con revenido especial.

Code	Ø		←L→ mm	MM	g	EAN	
	mm	"					
01575000421	4	5/32	120	10	64	10	030389
01575000521	5	3/16	150	12	120	10	030396



1576

Automatischer Körner

Chrom-Vanadium, C = verchromt, stufenlos einstellbar, Schlagkraft wird durch einfaches Herunterdrücken des Kopfes freigesetzt.

Adjustable center punch

Chrome-Vanadium, C = chromium plated, continuously adjustable, punch will be released by pressing the button.

Poiteau automatique

Chrome-Vanadium, C = chromées, réglable en continu, la force d'impact est relâchée par simple pression de la tête.

Granete automático

Cromo Vanadio, C = cromado, graduable sin escalones, la potencia de golpeo se activa por simple apriete del cabezal.



Code	mm	Ø "	←L→ mm	g	g	EAN
01576013080	2	5/64	135	81	1	372519



Gerändelte Oberfläche sorgt für sicheren Halt (Abrutschsicher).
Knurled surface for a secure fit (prevents slipping).

1577

DIN 6434

Nietzieher mit Sicherheitsschlagkopf

Chrom-Vanadium

Rivet-set with non-spreading safety head

Chrome-Vanadium

Jeu de chasse-rivets tête de sécurité

Chrome-Vanadium

Sacaremaches con cabeza de seguridad

Cromo Vanadio



Code	mm	mm	←L→ mm	mm	g	g	EAN
01577010200	2	2,5	100	10	60	10	387117
01577010300	3	3,5	100	10	60	10	387124
01577010400	4	4,5	100	12	70	10	387131
01577011500	5	6,0	110	12	100	10	387148
01577011600	6	7,0	110	14	120	10	387155

1578

DIN 6435

Nietkopfmacher mit Sicherheitsschlagkopf

Chrom-Vanadium

Rivet-header with non-spreading safety head

Chrome-Vanadium

Chasse-clous avec tête de sécurité

Chrome-Vanadium

Buterola con cabeza de seguridad

Cromo Vanadio



Code	mm	mm	←L→ mm	mm	g	g	EAN
01578010200	2	3,5	100	10	60	10	387162
01578010300	3	5,2	100	10	60	10	387179
01578010400	4	7,0	100	12	80	10	387186
01578011500	5	8,8	110	14	140	10	387193
01578011600	6	10,5	110	16	180	10	387209

1610

DIN 6473 B

Metallsägebogen, verstellbar

C/CL Metallsägeblatt HEYCO 1617 (einseitig gezahnt, Schnellstahl)

Adjustable hacksaw frames

C/CL hacksaw blade HEYCO 1617 (single edge, high speed steel)

Montures de scie, ajustables

C/CL lame de scie HEYCO 1617 (denture simple, acier rapide)

Arcos de sierra para metales, ajustables

C/CL hoja de sierra para metales HEYCO 1617 (dientes por un lado, de acero rápido)



Code	←L→ mm	für Blätter/for blades mm	"	g	g	EAN
01610000080	450	250 + 300	10 + 12	380	1	030433

1615 - 1617

DIN 6494

Metallsägeblätter

ST = standardmäßig 24 Zähne per Zoll

Hacksaw blades

ST = standard, 24 teeth per inch

Lames de scie à métaux

ST = standard, 24 dents au pouce

Hojas de sierra para metales

ST = estándar, 24 dientes por pulgada



1615



1616



1617

1615 einseitig gezahnt, 2% wolframlegiert,
1616 doppelseitig gezahnt, 2% wolframlegiert
1617 einseitig gezahnt, Schnellstahl

1615 single edge, 2% tungsten
1616 double edge, 2% tungsten
1617 single edge, high speed steel

Code	No.	Maße/dimensions mm	g	g	EAN
01615030000	1615	300 x 13 x 0,63	20	50	030457
01616030000	1616	300 x 25 x 0,80	38	50	030464
01617030000	1617	300 x 13 x 0,65	20	50	030471

1621

Hebelblechscheren

Chrom-Molybdän-Stahl, phosphatiert, HRC 60-62

Schneidekapazität:

Metall bis zu 1,5 mm, Edelstahl bis zu 0,9 mm

Compound action snips

Chrome molybdenum steel, phosphated, HRC 60-62

Cutting capacity:

Metal up to 1,5 mm, stainless steel up to 0,9 mm

Cisailles à tôle démultipliées

Acier chrome de molybdène, phosphaté, HRC 60-62

Capacité de coupe:

Métal jusqu'à 1,5 mm, acier inoxydable jusqu'à 0,9 mm

Tijeras para chapa, articuladas

Acero al cromo molibdeno, fosfatada, HRC 60-62

Capacidad de corte:

Metal hasta 1,5 mm, acero inox. hasta 0,9 mm

Code	No.	mm	↔ L ↔	"	g	g	EAN
01621000132	1621-1	260		10.3/8	520	1	030488
01621000232	1621-2	260		10.3/8	520	1	030495
01621000332	1621-3	260		10.3/8	480	1	371888

1621-1

rechtsschneidend
right hand cutting
coupe droite
corta a la derecha



1621-2

linksschneidend
left hand cutting
coupe gauche
corta a la izquierda



1621-3

gerade
straight
droite
corta derecho



1622

Hebelblehscheren 90° abgewinkelt

Chrom-Molybdän-Stahl, gesandstrahlt.
Geschmiedete Klingen für eine höhere Festigkeit und
längere Lebensdauer, HRC 60-62

Schneidekapazität:

Metall bis zu 1,2 mm, Edelstahl bis zu 0,7 mm

Universal finnen's snips 90° bent

Chrome molybdenum steel, sandblasted.
Forged blades for greater strenght and longer durability, HRC 60-62

Cutting capacity:

Metal up to 1,2 mm, sStainless steel up to zu 0,7 mm

Cisailles à tôle démultipliées

Acier chrome de molybdène, sablé.

Lame forgées pour une meilleure force, et une plus
grande durabilité, HRC 60-62

Capacité de coupe:

Métal jusqu'à 1,2 mm, acier inoxydable jusqu'à 0,7 mm

Tijeras para chapa, dobladas a 90°

Acero al cromo molibdeno granalladas.

Hojas forjadas para una mayor dureza y duración, HRC 60-62

Capacidad de corte:

Metal hasta 1,2 mm, acero inox hasta 0,7 mm

Code	No.	←L→		g	g	EAN
		mm	"			
01622000132	1622-1	260	10.3/8	520	1	371871
01622000232	1622-2	260	10.3/8	520	1	371864

1622-2

linksschneidend

90° abgewinkelt

left hand cutting

90° bent

coupe gauche

corta a la izquierda



1622-1

rechtsschneidend

90° abgewinkelt

right hand cutting

90° bent

coupe droite

corta a la derecha



1626

Lochscherer

LG = lackiert, Kopf gesandstrahlt, rechtsschneidend

Hole cutting snip

LG = lacquered, sand blasted head, right hand cutting

Cisailles coupe-trou

LG = laquées, tête sablée, chantourneuse à droite

Tijeras para chapa - de carrocerero

LG = barnizado, cabeza granallada, corte a derecha

Code	←L→		g	g	EAN
	mm	"			
01626025025	250	10	455	1	030563



1640

Mini-Rohrabschneider

L = lackiert, *Ersatz-Schneiderad

Mini-tube-cutter

L = lacquered, *Replacement cuttingwheel

Mini coupe-tube

L = laquées, *Roulette de rechange

Mini-cortatubos

L = barnizado, *Rueda cortante de repuesto



Code	No.	←L→ mm				EAN
0164000020	1640	72	25	145	1	371956
*0164010000	1640-1			5	1	371925

1641

Rohrabschneider

L = lackiert, *Ersatz-Schneiderad

Tube-cutter

L = lacquered, *Replacement cuttingwheel

Coupe-tube

L = laquées, *Roulette de rechange

Cortatubos

L = barnizado, *Rueda cortante de repuesto



Code	No.	←L→ mm				EAN
0164100020	1641	135	35	250	1	371949
*0164110000	1641-1			5	1	371918



1642

Rohrabschneider

L = lackiert, schwere Ausführung, *Ersatz-Schneiderad

Tube-cutter

L = lacquered, heavy version, *Replacement cuttingwheel

Coupe-tube

L = laquées, exécution lourde, *Roulette de rechange

Cortatubos

L = barnizado, modelo fuerte, *Rueda cortante de repuesto



Code	No.	←L→ mm				EAN
0164200020	1642	195	32	490	1	371963
*0164210000	1642-1			5	1	371901

1643

Rohrabschneider

L = lackiert, *Ersatz-Schneiderad

Tube-cutter

L = lacquered, *Replacement cuttingwheel

Coupe-tube

L = laquées, *Roulette de rechange

Cortatubos

L = barnizado, *Rueda cortante de repuesto



Code	No.	←L→ mm				EAN
0164300020	1643	210	75	1010	1	371932
*0164310000	1643-1			5	1	371895

1659

Hartmetallschaber mit Radius

mit Inbusschlüssel, * Hartmetall-Schaberplatte mit Radius

Square scraper with replaceable carbide tip

with Allen Key, * Carbide scraper tip ready ground and lapped for square scraper





Raclette carré avec lame carbure remplaçable

avec clé allen, * Plaque de raclage carbide

Rascador de metal duro con radio

con llave Allen, * Placa de metal duro con radio



Code	 mm	 mm	 mm			EAN
01659030000	300	20	2	380	1	387056
01659035000	350	25	2	600	1	387063
01659035100	350	30	2	680	1	387070
*01659120200	25	20	2	15	3	387087
*01659125200	25	25	2	20	3	387094
*01659130200	25	30	2	25	3	387100

1660

Löffelschaber

LS = lackiert, Spitzen geschliffen

Curved bearing scrapers

LS = lacquered, ground tip



Grattoirs à cuillère

LS = laquées, pointes meulées

Rasqueteadores tipo cuchara

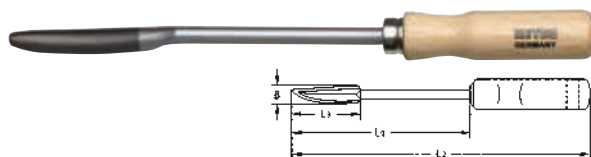
LS = barnizado, puntas amoladas



Code	mm	L ₁ "	L ₂ mm	L ₃ mm	B mm			EAN
01660020021	200	8	310	85	14	150	10	031188
01660025021	250	10	370	92	17	215	10	031195

1661

Dreikant-Löffelschaber

LS = lackiert, Spitzen geschliffen

Triangular bearing scrapers

LS = lacquered, ground tip



Grattoirs incurvés triangulaires

LS = laquées, pointes meulées

Rasqueteadores tipo cuchara - triangulares

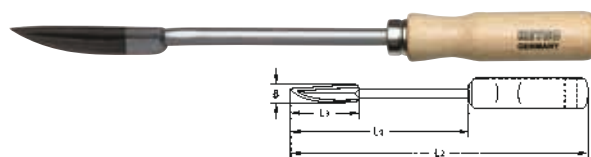
LS = barnizado, puntas amoladas



Code	mm	L ₁ "	L ₂ mm	L ₃ mm	B mm			EAN
01661020021	200	8	310	77	16	150	10	031225
01661025021	250	10	370	97	17	200	10	031232

1662

Dreikant-Hohlschaber

LS = lackiert, Spitzen geschliffen

Triangular hollow scrapers

LS = lacquered, ground tip



Grattoirs évidés triangulaires

LS = laquées, pointes meulées

Rasqueteadores tipo gubia - triangulares

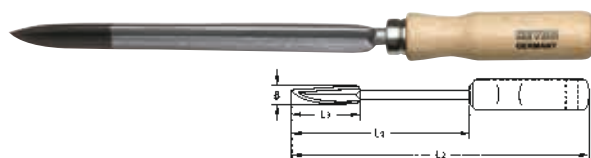
LS = barnizado, puntas amoladas



Code	mm	L ₁ "	L ₂ mm	B mm			EAN
01662020021	200	8	310	15	150	10	031263
01662025021	250	10	370	15	205	10	031270

1663

Flachschaber

LS = lackiert, Spitzen geschliffen

Square scrapers

LS = lacquered, ground tip

Grattoirs droits

LS = laquées, pointes meulées

Rasquetadores planos

LS = barnizado, puntas amoladas

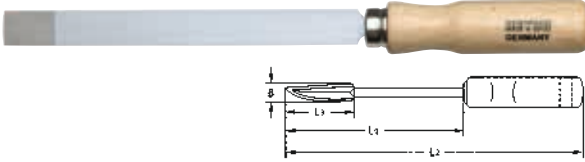

Code	mm	L ₁	"	L ₂	B	g	g	EAN
01663020021	200		8	310	19	220	10	031300
01663025021	250		10	370	24	305	10	031317

1664

PROFI-Cuttermesser

- 5 integrierte Klingen, selbstladend
- Schwere Ausführung - Zink-Druckguss, automatische Klingennarretierung
- Zusätzlicher Klingenfeststeller
- Automatischer Klingenswechsel
- Magazinbefüllung
- Verkaufsdisk mit 12 Stück
- Ersatzklingen 10 Stück

PROFI Cutter knives

- 5 integrated self loading blades
- Heavy version - zinc-die cast, automatic blade auto lock
- Additional locking of blade
- Automatic change of blade whatever the jaw opening
- Refilling of magazine
- Sales display with 12 pcs.
- Spare blade 10 pcs.

Couteau cutter PROF

- 5 lames intégrées, chargement auto-matique
- Exécution lourde - zingué sous pression, verrouillage automatique
- Supplémentaire Système de verouillage des lames
- Changement des lames automatique
- Remplissage du réservoir
- Affichage de vente avec 12 unités
- Lames de recharge 10 pièces

Cutter profesional

- 5 hojas integradas, de recarga automática
- Modelo fuerte, de fundición inyectada, fijación automática de la hoja
- Mecanismo adicional de fijación de la hoja
- Recambio automático de la hoja
- Recarga de la cámara
- Expositor de autoventa con 12 unidades
- Hojas de repuesto 10 piezas



Code	No.	Klingenbreite/ blade width	g	g	EAN
01664000200	SB 1664-2	9 mm	124	1	334654
01664000000	SB 1664	18 mm	250	1	329018



Verkaufsdisk/Sales display:

Code	No.	Klingenbreite/ blade width	g	g	EAN
01664021200	SB 1664-12-2	9 mm	1500	12	334647
01664001200	SB 1664-12	18 mm	3000	12	331554



Ersatzklingen/Spare blades:

Code	No.	Klingenbreite/ blade width	g	g	EAN
01664201000	SB 1664-10-2	9 mm	30	10	334661
01664101000	SB 1664-10	18 mm	80	10	329025



1664-4

Sicherheits-Cuttermesser

- Automatischer Klingeneinzug bei Nichtbenutzung
- Zink-Druckgussgehäuse mit ergonomischem 2-K Softgriff
- Einfacher Klingenwechsel
- Kompakte, ausfahrbare Bauform
- Verkaufsdisplay mit 12 Stück

Safety cutter knife

- Automatic blade feed when not in use
- Zinc die-cast housing with ergonomic 2-K soft handle
- Easy blade change
- Compact, retractable construction
- Sales display with 12 pcs.

Couteau cutter de sécurité

- Collecte automatique de la lame en cas de non-utilisation
- Boîtier en zinc moulé sous pression avec poignée souple ergonomique 2-K
- Changement simple de la lame
- Modèle compact retractable
- Affichage de vente avec 12 unités

Cutter de seguridad

- Retroceso automático de la hoja al no ser utilizada
- Carcasa de fundición de zinc con mango blando ergonómico 2-K
- Fácil cambio de hoja
- Diseño compacto retráctil
- Expositor de autoventa con 12 unidades



Code	No.	Klingenbreite/ blade width			EAN
01664000400	SB 1664-4	19 mm	158	1	402445



Verkaufsdisplay/Sales display:

Code	No.	Klingenbreite/ blade width			EAN
01664041200	SB 1664-12-4	19 mm	2050	12	402452

Ersatzklingen/Spare blades:

Code	No.	Klingenbreite/ blade width			EAN
01664301000	SB 1664-10-3	19 mm	50	10	367560



1665

Dichtungsschaber

Z = verzinkt, speziell geeignet für problemlose und rückstandsfreie Beseitigung von Dichtungsresten

Gasket scraper

Z = galvanized, particularly suitable for removing residues of gaskets

Grattoirs plats

Z = galvanisés, pour enlever les restes de joints sans problème

Rasquetadores para limpiar juntas

Z = zincado, especial para eliminar restos de juntas

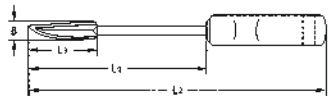

Code	mm	L ₁	"	L ₂	B	mm			EAN
01665028060	170		6.3/4	280	23	120	10		031324

1667

Türverkleidungs-Lösehebel

Z = verzinkt, zur Demontage von geklammerten Türverkleidungen

Door trim panel remover

Z = galvanized, for removing clipped doortrim panels

Levier de dégarnissage

Z = galvanisés, pour démonter les garnitures de portes fixées par clips

Palancas para soltar revestimientos de puertas

Z = zincado, para soltar revestimientos grapados de puertas



Code	mm		"			EAN
01667028060	280		11	140	10	031362

1668

Kabel-Klappmesser

ST = standardmäßig, rostfreie Klinge

Cable-folding knife

ST = standard, blade of stainless steel

Couteaux d'électricien avec dénudeur

ST = standard, lame d'acier inoxydable

Navajas de electricista

ST = estándar, hoja de acero inoxidable

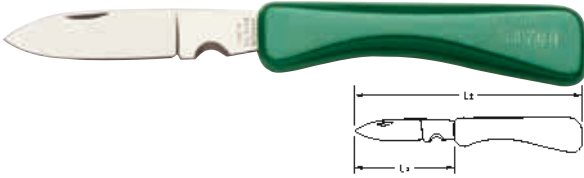

Code	mm	L ₁	"	L ₂ mm	g	g	EAN
0166800000	85		3.1/2	195	75	10	031379

1669

Sicherheits-Rettungsmesser

Hochwertiger Messerstahl.

Gürtelclip. Gurtschneider, Scheibenzertrümmer. Wellenschliff mit Sägeverzahnung. Genarbte Kunststoffeinlagen, Edelstahlschrauben.

Safety folding survival knife

High grade cutlery steel.

Belt clip. Seatbelt cutter, window pane breaker. Serrated blade with saw teeth. Grained plastic inlays; screws made of stainless steel.

Couteau de sauvetage

Couteau en acier de haute qualité.

Clip ceinture. Coupe ceinture, brise vitre. Lame crantée avec dents de scie. Inserts en plastique à grains fins, vis en acier inoxydable.

Navaja de salvamento de seguridad

Acero para cuchillas de alta calidad.

Clip de cintura. Cortante para cinturón de seguridad del coche, rompedor de lunas. Corte de perlado con dientes de sierra.

Injertos de plástico, tubos de acero inoxidable.



Code	mm	L ₁	"	L ₂ mm	g	g	EAN
0166900000	85		3.1/2	200	260	1	353365



1670

Gewindefeilen

ZCG = verzinkt, gelbchromatiert, zur Reparatur beschädigter Innen- und Außengewinde

Thread restorers

ZCG = galvanised, yellow chromated, for restoring damaged inside and outside threads

Outils à restaurer les filets

ZCG = galvanisés, jaune passivés, pour restaurer les filets abîmés intérieurs et extérieurs

Limas para restaurar roscas

ZCG = zincado, cromatizado amarillo, para restaurar roscas dañadas, interiores y exteriores



Code	No.	←L→ mm	g	g	EAN
01670000161	1670-M	230	125	10	031393

Gewindesteigung thread pitch	mm	0,80	1,00	1,25	1,50	1,75	2,00	2,50	3,00
metrisches Gewinde metric thread	mm	5	6	8	10	12	14	18	24
			7	9	11		16	20	27
								22	

Code	No.	←L→ mm	g	g	EAN
01670000261	1670-UNF (NF)	230	125	10	031409

Gänge auf 1 Zoll threads per 1 inch		24	20	18	16	14	13	12	11
UNF (NF)-Gewinde UNF (NF)-thread		5/16	7/16	9/16	3/4	7/8	–	1.1/8	–
		3/8	1/2	5/8		1		1.1/4	
								1.1/2	
UNC (NC)-Gewinde UNC (NC)-thread		–	1/4	5/16	3/8	7/16	1/2	9/16	5/8

1675 - 1679

DIN 7261/ISO 234/1

Werkstattfeilen

ST = standardmäßig, Hieb 2 – halbschlicht, Kreuzhieb

Engineers' files

ST = standard, second cut, cross-cut

Limes d'atelier

ST = standard, demi-douce, à taille double

Limas de taller

ST = estándar, talla 2 – entrefina, talla doble



1675



1676



1677



1678



1679

Code	No.	Form	L ₁		passendes Heft suitable handle	g	EAN	
			mm	"				
01675020000	1675	—	200	8	1681-30	175	10	031454
01675025000			250	10	1681-40	310	5	031461
01676020000	1676	◐	200	8	1681-30	125	10	031492
01676025000			250	10	1681-40	215	5	031508
01677020000	1677	▲	200	8	1681-30	145	10	031539
01677025000			250	10	1681-40	290	5	031546
01678020000	1678	■	200	8	1681-10	85	10	031577
01678025000			250	10	1681-20	150	5	031584
01679020000	1679	●	200	8	1681-10	70	10	031614
01679025000			250	10	1681-20	140	5	031621

— 1675 Flachstumpf-Feilen
1675 Hand files

◐ 1676 Halbrund-Feilen
1676 Halfround files

▲ 1677 Dreikant-Feilen
1677 Threesquare files

■ 1678 Vierkant-Feilen
1678 Square files

● 1679 Rund-Feilen
1679 Round files

1681

Feilenhefte

ST = standardmäßig, für Werkstattfeilen HEYCO 1675-1679

File handles

ST = standard, for engineers' files HEYCO 1675-1679

Poignées pour fichiers

ST = standard, pour limes d'atelier HEYCO 1675-1679

Los mangos de archivos

ST = estándar, para limas de taller HEYCO 1675-1679



Code	No.	←L→	Innen/inside Ø mm	g	EAN	
		mm				
01681001000	1681-10	100	5	27	10	410532
01681002000	1681-20	120	6	40	10	410556
01681003000	1681-30	100	7	27	10	410563
01681004000	1681-40	120	8	40	10	410570

1686 - 1686-1

Kontaktfeilen

B = brüniert

Contact files

B = gun-metal finish

Limes à contacts

B = brunies

Limas para platinos

B = pavonado

1686



1686-1



Code	No.	←L→		g	EAN	
		mm	"			
01686000030	1686	150	6	61	10	031782
01686000130	1686-1	150	6	7	5	031799

1686 Sätze à 6 Stück in Abreißtaschen

sets of 6 pcs. in tear-off bags, jeux de 6 pcs. en trousse,

juegos de 6 piezas en bolsa de plástico con bolsillos arrancables

1686-1 lose, loose, en vrac, sueltas

1689

DIN 7283

Schlüsselfeilen

B = brüniert, Hieb 2 – halbschlicht, Kreuzhieb

Warding files

B = gun-metal finish, second cut, cross-cut

Limes à clés

B = brunies, demi-douce, à taille double

Limas para cerrajero

B = pavonado, talla 2 – entrefina, talla doble

Code	←L→		je 1 Stück 1 pcs. each					g	10	EAN
	mm	"	▬	▴	▣	●	▬			
01689000030	150	6	▬	▴	▣	●	▬	115	10	031805



Sätze à 6 Stück in Plastiktaschen
sets of 6 pcs. in plastic wallets
jeux de 6 pcs. en trousse
juegos de 6 piezas, en bolsa de plástico

1702

Kolbenring-Spannbänder

ST = standardmäßig, stufenlose Einstellung durch Spannschlüssel

Piston ring compressors

ST = standard, infinitely variable adjustment with ratchet key

Colliers à segments

ST = standard, blocage progressif par clé de serrage

Ceñidores para segmentos de pistón

ST = estándar, ajuste sin escalones mediante tensor

Code	No.	Spannbreite/capacity		Höhe/depth		g	1	EAN
		mm	"	mm	"			
01702000100	1702-1	57-125	2.1/4-5	80	3.1/4	250	1	031829
01702000200	1702-2	90-175	3.1/2-7	80	3.1/4	295	1	031836
01702000300	1702-3	90-175	3.1/2-7	165	6.1/2	550	1	031843



LED`S VON IHRER STRAHLENDSTEN SEITE

LEDS FROM THEIR BRIGHTEST SIDE



YOU
TUBE





1721-1

1W-LED-Taschenlampe

- Hohe Energieeffizienz, extra lange Leuchtdauer
- Spritzwassergeschützt
- Oberfläche schwarz eloxiert
- Hochwertiges Aluminiumgehäuse, inkl. Schlaufe
- Batterien und Schlaufe im Lieferumfang enthalten

1W-LED Torchlight

- High energy efficiency, extra long duration
- Splash-proof
- Black anodized
- High-quality aluminum housing, incl. hanger
- Batteries and hanger included

Lampe de poche LED 1 W

- Grande efficacité énergétique, autonomie longue durée
- Résiste aux projections d'eau
- Surface noire anodisée
- Boîtier en aluminium de qualité avec dragonne
- Piles et dragonne comprises dans la livraison

Linterna LED de 1 W

- Una alta eficiencia energética, una iluminación muy duradera
- Protección frente a salpicaduras
- Superficie anodizada en negro
- Carcasa de aluminio de gran calidad y correa incluida
- Las pilas y la correa están incluidas



Code	←L→ mm			EAN
01721000100	110	110	1	367089



1721-3

3W-LED-Taschenlampe

- Hauptlicht 3 Watt Cree LED mit 250 LM
- Zusatzlicht 180 LM mit Arbeitslicht und blinkender Signalleuchte (rot)
- Starker Magnet zur Fixierung an metallischen Oberflächen
- Hohe Energieeffizienz, extra lange Leuchtdauer
- Spritzwassergeschützt
- Oberfläche schwarz eloxiert
- Kopfdurchmesser 45 mm
- Batterien im Lieferumfang enthalten

3W-LED Torchlight

- Main light 3 watt Cree LED with 250 LM
- Additional light 180 LM with working light and flashing signal (red)
- Strong magnet for fixing on metallic surfaces
- High energy efficiency, extra long duration
- Splash-proof
- Black anodized
- Head diameter 45 mm
- Batteries included

Lampe de poche LED 3W

- Éclairage principal: LED Cree 3 W à 250 LM
- Éclairage supplémentaire de 180 LM avec éclairage de travail et signal lumineux clignotant (rouge)
- Aimant puissant pour la fixation à des surfaces métalliques
- Grande efficacité énergétique, autonomie longue durée
- Résiste aux projections d'eau
- Surface noire anodisée
- Diamètre de la tête: 45 mm
- Piles comprises dans la livraison

Linterna LED de 3 W

- Luz principal de 3 vatios de LED de Cree con 250 LM
- 180 LM adicionales con luz de trabajo y luz indicadora intermitente (roja)
- Potente imán para fijación en superficies metálicas
- Una alta eficiencia energética, una iluminación muy duradera
- Protección frente a salpicaduras
- Superficie anodizada en negro
- Diámetro del cabezal de 45 mm
- Pilas incluidas



Code	←L→ mm			EAN
01721000300	175	270	1	422795



1721-2

10W-LED-Taschenlampe

- 10 Watt Cree LED, hohe Energieeffizienz, extra lange Leuchtdauer
- Zoomfunktion
- Spritzwassergeschützt
- Oberfläche schwarz eloxiert
- Powermodus 100%/900 LM, Sparmodus 50%/450 LM, Stroboskopmodus
- Kopfdurchmesser 50 mm
- Batterien und Gürteltasche im Lieferumfang enthalten

10W-LED Torchlight

- 10 watt Cree LED, high energy efficiency, extra long duration
- Zoom function
- Splash-proof
- Black anodized
- Power mode 100%/900 LM, power safe mode 50%/450 LM, stroboscope mode
- Head diameter 50 mm
- Batteries and belt pouch included

Lampe de poche LED 10W

- LED Cree 10 W, grande efficacité énergétique, autonomie longue durée
- Fonction zoom
- Résiste aux projections d'eau
- Surface noire anodisée
- Mode pleine puissance 100%/900 LM, mode économie d'énergie: 50%/450 LM, mode stroboscopique
- Diamètre de la tête: 50 mm
- Piles et étui pour port au niveau de la ceinture compris dans la livraison

Linterna LED de 10 W

- LED de Cree de 10 vatios, una alta eficiencia energética, una iluminación muy duradera
- Función de zoom
- Protección frente a salpicaduras
- Superficie anodizada en negro
- Modo potente al 100%/900 LM, modo ahorro al 50%/450 LM y modo estroboscópico
- Diámetro del cabezal de 50 mm
- Las pilas y la bolsa de cinturón están incluidas

Code	←L→ mm	g	1	EAN
01721000200	245	800	1	401950



- Hohe Energieeffizienz
- Extra lange Leuchtdauer
- Spritzwassergeschützt
- Oberfläche schwarz eloxiert

- High energy efficiency
- Extra long duration
- Splash-proof
- Black anodized



YOU
TUBE

1731

CE EN 166 / ANSI Z87.1

Schutzbrille „Sport“ mit Sehglasaufnahme

- Zertifizierte Produktion
- Integrierter, herausnehmbarer Brillenrahmen zur Aufnahme Ihrer individuellen Sehgläser
- Angenehmer Tragekomfort durch 2-K Weichkomponente an den Bügeln
- Auch ohne Sehglasaufnahme als Schutzbrille nutzbar

Protective glasses „Sport“ with eyeglass-holder

- Certified production
- Integrated, removeable spectacle frame as holder for your individual glasses
- 2-K soft component on the temple arms for high wearing comfort
- Can be used as protective glasses without eyeglass-holder

Lunette de protection „Sport“ avec support pour lunettes

- Production certifiée
- Cadre démontable comme support pour vos propres lunettes
- Composant 2-K sur les branches pour le confort élevé
- Peut être utilisé comme des lunettes de protection sans porte-lunettes

Gafas de protección „Sport“ con recipiente para cristales

- Producción certificada
- Montura para acoplar los cristales individuales
- Comportable utilización gracias a 2 componentes blandos en las patillas
- Utilizable también como gafas de protección sin el recipiente de cristales



Code	Modell			EAN
01731000000	Sport	40	1	394009

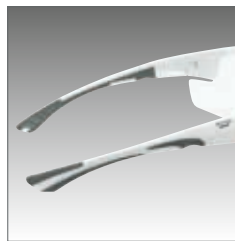

1731-1

CE EN 166 / ANSI Z87.1

Schutzbrille „Konventionell“ mit Sehglasaufnahme

Beschreibung siehe Artikel 1731

Protective glasses „Konventionell“ with eyeglass-holder

For the description, see article 1731

Lunette de protection „Konventionell“ avec support pour lunettes

Description voir article 1731

Gafas de protección „Konventionell“ con recipiente para cristales

Descripción, véase artículo 1731



Code	Modell			EAN
01731000100	Konventionell	40	1	394016

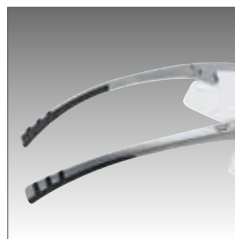

1754

Feilenbürste

ST = standardmäßig, Buchenholz mit Kratzenband besetzt

File card brush

ST = standard, beech wood with card brush

Brosses à limes

ST = standard, bois d'hêtre avec ruban à raclettes

Cepillos para rascar limas

ST = estándar, mango de madera de haya con banda rascadora

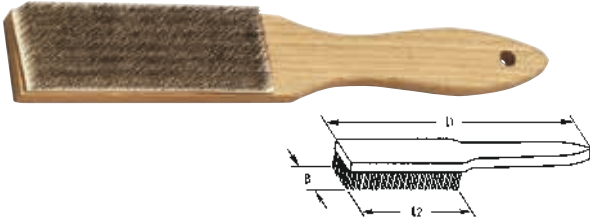

Code	L ₁ mm	L ₂ mm	B mm	g	g	EAN
0175400000	260	115	40	70	5	032031

1755

Stahl-Drahtbürsten

ST = standardmäßig, glatter Stahldraht Ø 0,35 mm

Wire brushes

ST = standard, with plain steel bristles Ø 0,35 mm

Brosses métalliques

ST = standard, fils d'acier lisses Ø 0,35 mm

Cepillos de alambre de acero

ST = estándar, alambre liso de Ø 0,35 mm

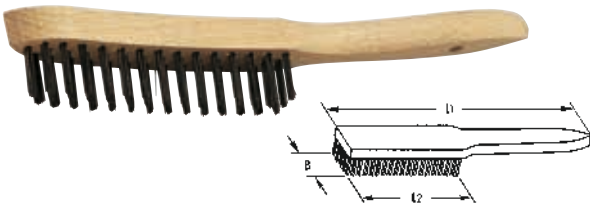

Code	Reihen rows	L ₁ mm	L ₂ mm	B mm	g	g	EAN
01755000300	3	290	130	30	125	5	032048
01755000400	4	290	130	35	130	5	032055

1757

Edelstahl-Drahtbürste

ST = standardmäßig, Edelstahl, Ø 0,35 mm, mit integriertem Schaber

Stainless steel wire brush

ST = standard, Stainless steel, Ø 0,35 mm, with integrated scraper

Brosse métallique en acier inoxydable

ST = standard, Acier inoxydable, Ø 0,35 mm, avec grattoir intégré

Cepillo de alambre inoxidable

ST = estándar, Acero inoxidable, Ø 0,35 mm, con arrascador integrado



Code	Reihen rows	L ₁ mm	L ₂ mm	B mm	g	g	EAN
01757000300	3	350	160	25	186	1	403398

1759

Zündkerzenbürste

ST = standardmäßig, gewellter Messingdraht Ø 0,15 mm

Spark plug brush

ST = standard, wavy brass bristles Ø 0,15 mm

Brosses à bougies

ST = standard, fils de laiton striés Ø 0,15 mm

Cepillos para limpiar bujías

ST = estándar, alambre ondulado de latón Ø 0,15 mm

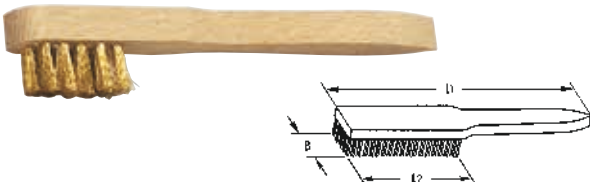

Code	Reihen rows	L ₁ mm	L ₂ mm	B mm	g	g	EAN
01759000300	3	150	32	15	18	10	032093

1781 - 1782-2

Ölspritzkannen

ST = standardmäßig, aus Kunststoff

Oil cans

ST = standard, made from plastic

Burettes à huile

ST = standard, en plastique

Aceiteras

ST = estándar, de plástico

1781

1781 Feinöler

1781 fine nozzle oilers

1781 burettes plates avec embout fin

1781 boquilla fina



Abbildung kann abweichen.
Illustration may differ.

1782-2

1782 mit herausziehbarem Spritzrohr

1782 with adjustable brass spout

1782 avec bec amovible

1782 con boquilla extraíble

1783

Ölspritzkanne

L = lackiert, Metall, Deckelteil aus Kunststoff, mit Messingdruckpumpe, 1 flexibles 1 starres Spritzrohr

Oil can

L = lacquered, Steel body, flexible reinforced, plastic spout, rigid brass spout, brass pump

Burettes à huile

L = laquées, Métal, couvercle en plastique avec pompe, en laiton, un bec flexible et un bec rigide

Aceiteras

L = barnizado, Metal, tapa de plástico con bomba de presión de latón con un tubo de inyección, flexible y otro rígido



1790-1

DIN 1283

Handhebel Fettpresse

L = lackiert, Kopf aus Zinkdruckguß, robuster Stahlrohrkörper mit Rändelung für rutschsichere Handhabung, mit 300 mm langem Gummipanzerschlauch Ø 12 mm und 4-Backen-Hydraulikmundstück. Anschlußgewinde M 10 x 1.

High pressure grease gun

L = lacquered, head of zinc die-casting, robust steel body with knurling for non-slip handling, with high pressure rubber tube of 300 mm length, 12 mm Ø and 4-jaw hydraulic connector, connecting thread M 10x1.

Pompes à graisse à levier

L = laquées, tête en zinc injecté, corps robuste en tôle d'acier avec rainures antidérapantes, équipées d'un bec flexible (Ø 12 mm, longueur 300 mm) et d'un embout hydraulique.

Aceiteras

L = barnizado, cabeza de fundición inyectada, cuerpo de tubo de acero con grafilado para evitar que resbale en la mano, con manguera de goma reforzada de 300 mm, Ø 12 mm y boquilla hidráulica de 4 mordazas, rosca de conexión M 10x1.



Code	No.	Volumen/volume		g	g	EAN
		ccm	pint			
01781002500	1781	25	1/16	10	10	032116
01782025000	1782-2	250	1/2	55	20	032130

Code	Volumen/volume		g	g	EAN
	ccm	pint			
01783030020	300	5/8	240	12	162745

Code	Inhalt/capacity ccm lose bulk	Kartuschen cartridges	← L →		g	g	EAN
			mm	"			
01790000120	500	400	380/690	1220	1	032161	

Zur Füllung mit Kartuschen, losem Fett und durch Füllgeräte.
For loading with cartridges, bulk grease or by filler pumps.

1805

Lochkreis-Messschieber

Für Lochkreis-Messungen an Stahl- und Alufelgen
Einfaches Ermitteln des Lochkreises, Messwerte-Ermittlung in mm.
Hochwertige Aluminium-Ausführung.

Bolt circle measuring gauge

For taking measurements on bolt circles of steel- and aluminium rims
Easy determination of the bolt circle, value indication in mm. High grade aluminium version.

Pied à coulisse

Pour les mesures des trous d'alésage sur l'acier et les jantes en aluminium
Simple détermination du trou d'alésage, détermination de la valeur de mesure en mm. Aluminium de haute qualité.

Pie de rey para diámetros de agujeros

Para medir diámetros de agujeros en llantas de acero y aluminio
Determinación sencilla del diámetro del agujero, determinación del valor de medida en mm. Fabricado en aluminio de alta calidad.



Code	←L→ mm	g	g	EAN
01805024000	84	240	1	378375



Geeignet für 3-, 4-, 5-, 6-Loch Felgen.
Feststellschraube zum Fixieren des Messwertes.
Suitable for 3-, 4-, 5-, 6-hole rims.
Locking screw for fixation of the value.

1806

DIN 862

Präzisions-Schieblehre

C = verchromt, rostfreier Stahl, Ableseteile matt verchromt, Rückseite mit Gewindetabelle, in Kunstleder tasche

Precision vernier caliper

C = chromium plated, stainless steel, scale markings satin chrome finish back with thread table, in imitation leather bag

Pieds à coulisse de précision

C = chromées, acier inoxydable, vernier et règle chromées mat, revers avec tableau de filet, en trousse simili-cuir

Calibres pie de rey, de precisión

C = cromado, acero inoxidable, escala y nonios cromados mate, tabla de roscas al dorso, en funda de imitación cuero



Code	mm	Nonius/vernier mm	g	g	EAN
01806015080	150	6	1/20	1/128	185 5 032192

1807

Digitale Präzisionsschieblehre

Material: Edelstahl, Messbereich: 0 - 150 mm / 6",
Resolution: 0.01 mm / 0.0005", Genauigkeit: ± 0,03 mm
Hochwertiges Metallgehäuse. Umschaltbar metrisch/inch.

Digital precision vernier caliper

Material: Stainless steel, Measuring range: 0 - 150 mm / 6"
Resolution: 0.01 mm / 0.0005", Accuracy: ± 0,03 mm
High grade metal housing. Switchable metric/inch.

Pieds à coulisse digital

Matériau: Acier inoxydable, Mesure: 0 - 150 mm / 6"
Résolution: 0.01 mm / 0.0005", Précision: ± 0,03 mm
Boîtier métallique de haute qualité. Interchangeable métrique/pouce.

Calibre pie de rey digital, de precisión

Material: Acero inoxidable, Capacidad: 0 - 150 mm / 6"
Resolución: 0.01 mm / 0.0005", Limite de error: ± 0,03 mm
Cuerpo metálico. Cambio métrico/pulgadas.



Code	No.	mm	Nonius/vernier mm	g	g	EAN
01807015080	1807	150	6	380	1	359954

In stabiler Kunststoffbox, inkl. Batterie.
In strong plastic box, incl. Battery.

Mit Umrechnungstabelle.
With conversation table.



1814

Fühlerlehren

P/N = poliert (Blätter) / vernickelt (Scheiden), konische Blattform, Blätter verschraubt

Feeler gauges

P/N = polished (blades) / nickel plated (sheaths), tapered blades, blades screwed into sheath

Jauges d'épaisseur

P/N = polies (lames)/amature nickelée, lames à bout pointu, lames fixées par un axe vissé

Galgas de espesores

P/N = pulido (hojas) / niquelado (monturas), hojas de forma cónica, unidas por tornillo



Code	No.	tlg. pcs.	Messbereich measuring range	←L→ mm			EAN
01814000240	1814-2	13	0,05 – 1,0 mm	100	66	10	032215
01814000440	1814-4	20	0,05 – 1,0 mm	100	105	10	032239

Code	No.	tlg. pcs.	Messbereich measuring range	←L→ mm			EAN
01814000240	1814-2	13	0,002 - 0,04"	100	66	10	032215
01814000440	1814-4	20	0,002 - 0,04"	100	105	10	032239

1815

2 in 1 Bremsscheiben-Messschieber und Reifenprofil-Messlehre

Zum Messen der Bremsscheibenstärke bei PKW + Motorrädern im eingebauten Zustand. Aus rostfreiem Stahl. Mit Feststellschraube und zusätzlicher Reifenprofil-Messlehre.

2 in 1 Brake- and tyre profile-caliper

For measuring the thickness of built-in braking discs of passenger cars and motorbikes. Made of stainless steel. With locking screw and additional tyre profile-caliper.

Pied à coulisse 2 en 1 pour contrôler l'épaisseur des disques de frein

Permet une mesure roue en place des voitures ou les motos. Acier inoxydable. Avec vis de blocage et jauge supplémentaire.

Calibre de freno 2 en 1 y calibre para perfil de neumático

Para medir el grosor del disco de freno en coches y motos sin tener que desmontar las piezas. Hecho de acero inoxidable. Con tornillos de fijación y un calibre adicional del neumático.

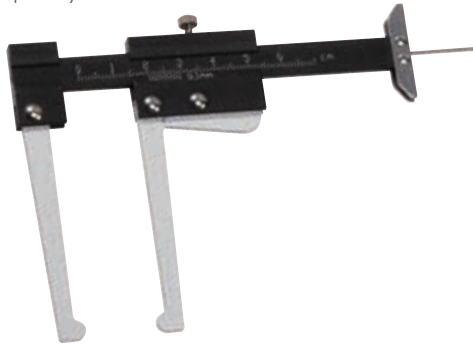

Meßbereich: 0-60 mm.
Measuring range: 0-60 mm.

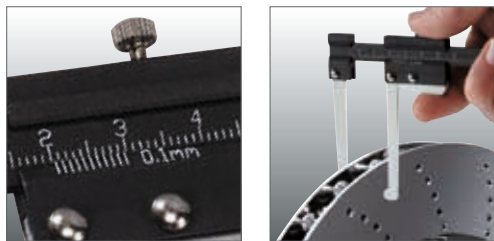

Code	←L→ mm	"	Querschnitt section mm			EAN
01836030000	300	12	30 x 1,0	77	10	032604

1836

Präzisions-Stahlmaßstab

Typ Chesterman, ST = standardmäßig, rostfreier Stahl
Teilung – obere Kante 0,5 + 1,0 mm, untere Kante 1/16, 1/32, 1/64"

Precision steel rule

Chesterman Type, ST = standard, stainless steel
graduation – top edge 0,5 + 1,0 mm, bottom edge 1/16, 1/32, 1/64"

Règlets de précision

Modèle Chesterman, ST = standard, acier inoxydable
graduation – bord supérieur 0,5 + 1,0 mm, bord inférieur 1/16, 1/32, 1/64"

Reglas de precisión, de acero

Tipo Chesterman, ST = estándar, acero inoxidable
divisiones: canto superior 0,5 + 1,0 mm, canto inferior 1/16, 1/32, 1/64"



1837

Holzgliedermaßstab, 2 m

Genauigkeitsklasse EG III, aus Buchenholz, Gliederstärke 3,0 mm, Gliederhöhe 16 mm, Gliederzahl 10, durchgenietete Gelenke und vermessingte Stahlfedern, 2 m Länge.

Beechwood folding rule, 2 m

EC accuracy class III, beechwood, section thickness 3,0 mm, section height 16 mm, no of sections 10, riveted and brass-plated, spring joints, 2 m length.

Mètre pliant, 2 m

CE classe de précision III, hêtre, épaisseur de 3,0 mm, hauteur de section 16 mm, 10 compartiments, jointures rivetées et laiton chromé à ressort, longueur 2 m.

Metro plegable de madera, 2 m

Clase de precisión CE III, de madera de haya, grosor de hoja 3,0 mm, anchura de hoja 16 mm, número de hojas 10, articulaciones con remaches ocultos y muelles de acero latonado.



Code	Messbereich measuring range	g	g	EAN
01837020000	200 cm	120	1	377569

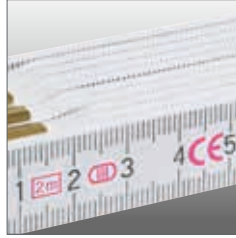

1840-5

Bandmaß 5 m

Metrisch/inch. Soft-Grip. Metallgehäuse. Stopfunktion. Nylon beschichtet. Magnete. Gürtelclip. Verkaufsdisplay mit 12 Stück.

Measuring tape 5 m

Metric/inch. Soft-grip. Stainless steel case. Stop function. Nylon coated. Magnets. Belt clip. Sales display with 12 pcs.

Mesure de poche 5 m

Métrique/inch. Soft-Grip. Boîtier métallique. Fonction d'arrêt. Gainé de nylon. Aimants. Clip de ceinture. Affichage de vente avec 12 unités.

Flexómetros 5 m

Métricos/inch. Soft-Grip. Carcasa metálica. Botón de freno. Cinta recubierta de nylon. Imanes. Clip para el cinturón. Expositor de autoventa de 12 unidades.



Code	←L→ mm	Bandbreite/width of tape mm	g	g	EAN
01840500000	5000	18	325	1	329032
01840051200	5000	18 Display	3900	12	331561

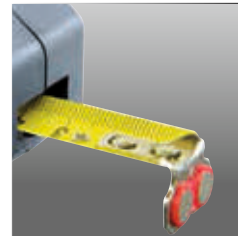

1840-8

Bandmaß 8 m

Metrisch/inch. Soft-Grip. Metallgehäuse. Stopfunktion. Nylon beschichtet. Magnete. Gürtelclip. Verkaufsdisplay mit 12 Stück.

Measuring tape 8 m

Metric/inch. Soft-grip. Stainless steel case. Stop function. Nylon coated. Magnets. Belt clip. Sales display with 12 pcs.

Mesure de poche 8 m

Métrique/inch. Soft-Grip. Boîtier métallique. Fonction d'arrêt. Gainé de nylon. Aimants. Clip de ceinture. Affichage de vente avec 12 unités.

Flexómetros 8 m

Métricos/inch. Soft-Grip. Carcasa metálica. Botón de freno. Cinta recubierta de nylon. Imanes. Clip para el cinturón. Expositor de autoventa de 12 unidades.



Code	←L→ mm	Bandbreite/width of tape mm	g	g	EAN
01840800000	8000	22	470	1	367263
01840081200	8000	22 Display	5800	12	367256



1842

Reißnadel

Chrom-Vanadium, B = brüniert

Scriber

Chrome-Vanadium, B = gun-metal finish

Pointes à tracer

Chrome-Vanadium, B = brunies

Puntas de trazar

Cromo Vanadio, B = pavonado



Code	←L→		g	g	EAN
	mm	"			
01842025030	250	10	45	10	032635

1856

Reifendruckprüfer

CPP = verchromt, ganz poliert, mit Taschenclip

Tyre pressure gauges

CPP = chromium plated, fully polished, with pocket clip

Contrôleurs de pression de gonflage

CPP = chromées, entièrement polis, avec agrafe métallique

Manómetros para neumáticos

CPP = cromado, enteramente pulido espejo, con clip



Code	No.	Meßbereich/measuring range		g	g	EAN
		bar	lbs./sq. in			
01856000383	1856-3	0,5 – 3,5	6 – 50	45	10	032734
01856000483	1856-4	0,8 – 8,2	10 – 120	55	10	032741

1857

Digitale Reifenprüfer mit 3 Funktionen im Verkaufsdisplay

Profiltiefe-Messung: 0-22 mm/8"

Reifendruck-Messung: 0-7.0 Bar/0-100 PSI/0-7.0 kg/cm²

Licht Genauigkeit: ± 1%

Digital tyre gauge with 3 function in sales display

Measuring tread depth: 0-22 mm/8"

Measuring pressure: 0-7.0 Bar/0-100 PSI/0-7.0 kg/cm²

Light Accuracy: ± 1%

Contrôleurs de pression de gonflage à 3 fonctions

Jauge de profondeur des pneus: 0-22 mm/8"

Mesure de pression des pneus: 0-7.0 Bar/0-100 PSI/0-7.0 kg/cm²

Lumière Précision: ± 1%

Comprobador de la presión de neumáticos de 3 funciones, en display de autoventa

Medición de la profundidad del perfil: 0-22 mm/8"

Medición de la presión del neumático: 0-7.0 Bar/0-100 PSI/0-7.0 kg/cm²

Luz Exactitud: ± 1%



Code	No.	Meßbereich/measuring range			g	g	EAN
		bar	psi	kg/cm			
01857000000	1857	0.0 – 7.0	0 – 100	0.0 - 7.0	70	12	358667



Inkl. Batterie 3 V CR2032,
Verkaufsdisplay mit 12 Stück.
Incl. battery 3 V CR2032,
sales display with 12 pcs.



1905

Stethoskop

ST = standardmäßig, Abhorchgerät zur Feststellung und Lokalisierung von defekten Lagern, Ventilen, Kolben, Stirnrädern usw., übertragungsstarke Membrane

Mechanics' stethoscope

ST = standard, sound detector for locating defective bearings, valves, pistons, spur pinions etc., with sound amplifying diaphragm

Stéthoscope

ST = standard, permet la localisation aisée des défauts des roulements, soupapes, pistons, engrenages etc., membrane de transmission puissante

Estetoscopio

ST = estándar, para detectar y localizar defectos en cojinetes, válvulas, émbolos, engranes etc., con membrana potente



Code	Spitze/probe tip mm	←L→		g	g	EAN
		mm				
01905000000	150		1055	180	1	032758

1920

Isolierband

ST = standardmäßig (schwarz)

Insulating tape

ST = standard (black)

Rouleaux de ruban adhésif

ST = standard (noir)

Cintas aislantes

ST = estándar (color negro)

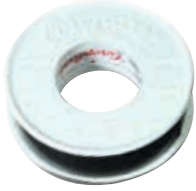

Code	←L→ mm	g	10	EAN
01920100000	10	31	10	032819

2010-3

Achsölwanne, 3 L

- 3 l Fassungsvermögen, mit praktischen Tragegriffen
- Sicheres Auffangen und Transportieren von flüssigen Medien
- Öl- und Chemikalienbeständig
- Praktische Ausgießöffnung zum einfachen Umfüllen

Drain pan for axle oil, 3 L

- 3 l capacity, perfect fit for the wheel hub and the rim well
- Secure collection and transport of fluids
- Oil- and chemicals-resistant
- Practical pouring spout for easy decanting

Recupérateur d'huile, 3 L

- Capacité 3 litres, ajustement parfait à la roue/jante
- Collecte et transport sécurisé des liquides
- Résistant aux huiles et produits chimiques
- Bec verseur pratique

Recipiente de aceite de eje 3L

- Capacidad de 3 litros, perfecto acomplamiento al eje y a la cama de la llanta
- Segura colección y transporte de fluidos
- Resistente al aceite y a productos químicos
- Práctico diseño de la boca para facilitar la transmisión del líquido



Optimale Passform, angepasst auf Radnabe / Felgenbett
With practical handles.

L: 315 mm
B: 245 mm
H: 160 mm

Code	Liter	g	1	EAN
02010000300	3	400	1	381764

2010-8

Auffangwanne für flüssige Medien, 8 L

- 8 l Fassungsvermögen, mit praktischer Ausgießtrübe
- Flach, Öl- und Chemikalienbeständig, Polyethylen
- Rundumlaufender Überlauftrand

Drain pan, 8 L

- 8 l capacity, with practical handle
- Flat, oil- and chemicals-resistant, Polyethylene
- Overflow channel around

Puisards pour liquides, 8 L

- Capacité 8 litres, avec bec verseur pratique
- Plat, résistant aux huiles et aux produits chimiques, Polyéthylène
- Bord de débordement au tour

Recipiente para recoger líquidos, 8 L

- Capacidad 8 litros, con boquilla para el vaciado
- Plano, resistente a aceites y productos químicos, Polietileno
- Borde integral para evitar que se desborde el líquido



L: 520 mm
H: 140 mm
Ø: 320 mm

Code	Liter	g	1	EAN
02010000800	8	650	1	372014

2010-10

Auffangwanne für flüssige Medien, 10 Liter, mit Kanister

10 l Fassungsvermögen. Flach, Öl- und Chemikalienbeständig, Polyethylen. Sicherer Transport von Öl.

Drain pan, 10 L, with canister

10 l capacity. Flat, oil- and chemicals-resistant, Polyethylene. Secure transport of oil.

Puisards pour liquides, 10 L, avec réservoir

Capacité 10 litres. Plat, résistant aux huiles et aux produits chimiques, Polyéthylène. Transport en toute sécurité de pétrole.

Recipiente para recoger líquidos, 10 L, con bidón

Capacidad 10 litros. Plano, resistente a aceites y productos químicos, Polietileno. Para el transporte seguro de aceites.



Flache Ausführung, mit praktischem Tragegriff.
Flat design, with practical handle.



L: 567 mm
B: 321 mm
H: 126 mm

Code	Liter			EAN
02010001000	10	1050	1	372007

2011

Multifunktionstrichter 2 in 1

Trichter aus Polypropylen. 1,2 L Fassungsvermögen.

Multifunction funnel 2 in 1

Funnel made of polypropylene. Capacity 1,2 L.

Entonnoir multifonction 2 en 1

Entonnoir en polypropylène. Capacité de 1,2 L.

Embudo multifuncional 2 en 1

Embudo de polipropileno. Capacidad 1,2 litros.



Edelstahlsieb zum Schutz vor Verunreinigung.
Stainless steel sieve to protect against pollution.



Flexibler Ausgießer, 340 mm.
Flexible spout, 340 mm.



Transparenter Schlauch für Wasser, Bremsflüssigkeit etc., 600 mm Länge.
Transparent hose for water, break fluid etc., 600 mm length.



Code	Liter			EAN
02011000000	1,2	471	1	372496

2012

Magnethaftschale

Haftmagnet rückseitig für die flexible Montage. Magnethaftschale für Schrauben, Bolzen, Kleinteile etc.. 150 mm Durchmesser. Gummischutzplatte verhindert Kratzer auf Karosserieteilen.

Magnetic shell

Adhesive magnet on the rear side for flexible mounting. Magnetic shell for screws, bolts, small parts etc.. Diameter 150 mm. Rubber protection plate prevents scratches on auto body parts.

Bol magnétique

Dos magnétique pour montage flexible. Bac magnétique pour vis, boulons, etc quincaillerie. 150 mm de diamètre. Plaque de protection en caoutchouc empêche les rayures sur les parties de carrosserie.

Bandeja imantada

Imán al dorso para un montaje flexible. Bandeja imantada para tornillos, pasadores, piezas metálicas etc.. Diámetro 150 mm. La placa protectora de goma evita raspaduras en la carrocería.



Hochwertige Ausführung. Aus rostfreiem Edelstahl.
Top quality. Made of stainless steel.



Code				EAN
02012000000	3 kg	402	1	327502

2013

Bremsflüssigkeitstester

- Ermittelt die Qualität von DOT 4 Bremsflüssigkeiten
- Zeigt an, wie groß der Wasseranteil in der Bremsflüssigkeit ist und dementsprechend, wann die Bremsflüssigkeit gewechselt werden soll
- Inkl. Batterie 1,5 V AAA

Brake fluid tester

- Determines the quality of DOT 4 brake fluids
- Tested and indicated on five LEDs in terms of „per cent of water in the brake fluid“
- Incl. battery 1,5 V AAA

Testeur de liquide de frein

- Détermine la qualité des liquides de frein DOT 4
- Indique le pourcentage d'eau dans le liquide de frein et indique lorsque le liquide de frein doit être changé
- Batteries inclus 1,5 V AAA

Comprobador del líquido de frenos

- Determina la calidad de los líquidos de frenos DOT 4
- Indica el contenido de agua en el líquido de frenos y determina cuándo hay que cambiarlo
- Inclusive pila 1,5 V AAA

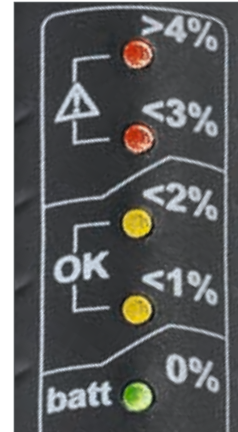

Code	No.	←L→ mm	g	g	EAN
02013000000	2013	145	80	1	375169

2013-1

Bremsflüssigkeitstester 8 in 1

Für alle Bremsflüssigkeitsarten:
DOT 3, DOT 4, DOT 5.1, ACD elco DOT 3, Pennzoil DOT 3, Prestone DOT 3, Motorcraft DOT 3, Toyota DOT 3
Dieser Tester ist dafür bestimmt, den Zustand der Bremsflüssigkeit zu ermitteln. Er wird durch 5 LED angezeigt. Mit LED-Leuchte.
Für alle Bremsflüssigkeitsarten.

Brake fluid tester 8 in 1

For all kinds of brake fluids:
DOT 3, DOT 4, DOT 5.1, ACD elco DOT 3, Pennzoil DOT 3, Prestone DOT 3, Motorcraft DOT 3, Toyota DOT 3
The purpose of this tester is to examine the quality of the brake fluid. The quality of the brake fluid will be indicated by 5 LED. With LED illumination. For all kinds of brake fluids.

Testeur liquide de frein 8 en 1

Pour tous les types de liquide de frein: DOT 3, DOT 4, DOT 5.1, ACD Elco DOT 3, Pennzoil DOT 3, Prestone DOT 3, DOT 3 Motorcraft, Toyota DOT 3
Cet appareil est destiné à déterminer l'état du liquide de frein. La qualité du liquide de frein sera indiqué par 5 LED. Avec illumination à LED. Pour tous les types de liquides à frein.

Comprobador de líquido de freno 8 en 1

Para todo tipo de líquidos de freno DOT 3, DOT 4, DOT 5.1, ACD elco DOT 3, Pennzoil DOT 3, Prestone DOT 3, Motorcraft DOT 3, Toyota DOT 3
Este comprobador se usa para comprobar la consistencia del líquido de freno. Se señala por 5 LED con lámpara LED. Con iluminación LED. Para todo tipo de líquidos de freno.

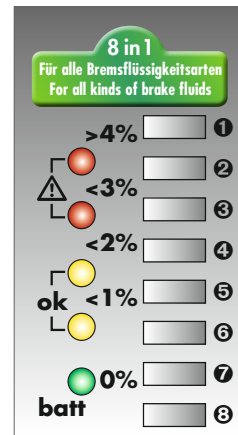

Code	No.	←L→ mm	g	g	EAN
02013000100	2013-1	155	85	1	398519

2014

Lambdasonde-Spezialwerkzeug

Chrom-Vanadium, C = verchromt
 Spezialwerkzeug für Lambdasonden an VW, Audi, BMW, Mercedes, Ford, Opel, Vauxhall, Peugeot, Citroen, Renault, Seat, Skoda etc.

Lambda sensor-special tool

Chrome-Vanadium, C = chromium plated
 Special tool for lambda-sensors for VW, Audi, BMW, Mercedes, Ford, Opel, Vauxhall, Peugeot, Citroen, Renault, Seat, Skoda ...

Outil spécial pour sonde Lambda

Chrome-Vanadium, C = chromées
 Outil spécial pour sonde Lambda pour VW, Audi, BMW, Mercedes, Ford, Opel, Vauxhall, Peugeot, Citroen, Renault, Seat, Skoda...

Herramienta especial - sonda Lambda

Cromo Vanadio, C = cromado
 Herramienta especial para sondas Lambda para VW, Audi, BMW, Mercedes, Ford, Opel, Vauxhall, Peugeot, Citroen, Renault, Seat, Skoda ...



Code	←L→ mm	MM	g	1	EAN
02014002280	250	22	480	1	380095



2015

Universal Keil- und Zahnriemenschlüsselsatz

Chrom-Vanadium, C = verchromt

- Zum Entspannen der automatischen Spannvorrichtung
- Einfaches Wechseln des Riemens
- Auch für schwer zugängliche Stellen geeignet
- Große Hebelübersetzung ermöglicht geringen Kraftaufwand
- Form- und Kraftschlüssige Verriegelung für sicheren Halt des Einsteckwerkzeuges. Einsteckwerkzeuge in Metrisch und Torx Schlüsselweiten für vielfältige Anwendungen.

Universal V-Belt and cam belt-wrench set

Chrome-Vanadium, C = chromium plated

- For releasing the automatic tensioning device
- Easy replacement of the belt
- Also suitable for places with difficult access
- High lever transmission for low effort
- Form and force-fitting locking device for secure maintaining of the tool. Tools with metric- and Torx-wrench sizes for multiple applications.

Jeu clés universelle pour écrous courroie tendeurs et courroie de distribution

Chrome-Vanadium, C = chromées

- Pour décrocher les écrous poulies
- Changement facile de la courroie de distribution
- Utilisable pour les éléments en position difficile
- Petite force pour grand levier
- Un verrouillage par vis permet de maintenir l'outil en toute sécurité.

Outils avec tailles métrique et Torx pour de multiples applications.

Juego de llaves universal para correas en cuña y dentadas

Cromo Vanadio, C = cromado

- Para destensar el dispositivo automático de tensión
- Fácil cambio de la correa
- Apto también para sitios de difícil acceso
- Gran transmisión por palanca, reduce el esfuerzo
- Cierre ajustado para seguro mantenimiento de la herramienta.

Herramientas intercambiables en métrica y torx, apertura para múltiples aplicaciones.

Code	enthaltend containing	tlg. pcs.	g	1	EAN
02015000080	2015-500 2015-20 2015-30	10	2770	1	382075



Hochwertige Schaumstoffeinlage im Metallkasten.
 High quality foam insert in metal case.



2015-500

Universal Keil- und Zahnriemenschlüssel

Chrom-Vanadium, C = verchromt. Ergonomischer Kunststoffgriff.

Universal V-Belt and cam belt-wrench

Chrome-Vanadium, C = chromium plated. Ergonomic plastic handle.

Clé universelle pour écrous courroie tendeurs et courroie de distribution

Chrome-Vanadium, C = chromées. Poignée ergonomique en plastique.

Llave universal para correas en V y dentadas

Cromo Vanadio, C = cromado. Mango ergonómico de plástico.



Code	←L→ mm	g	g	EAN
02015050080	500	500	1	381481

2015-20

Torx®-Einsteckschlüssel für Universal Keil- und Zahnriemenschlüssel

Chrom-Vanadium, C = verchromt

Torx® wrench insert tool for universal V-belt and cam belt-wrench

Chrome-Vanadium, C = chromium plated

Attache Torx® pour clé universelle pour tendeurs et courroie de distribution

Chrome-Vanadium, C = chromées

Torx® bits para llaves universales para correas en V y dentadas

Cromo Vanadio, C = cromado



Code	MM	g	g	EAN
02015201080	E 10	30	1	381375
02015201280	E 12	30	1	381382
02015201480	E 14	40	1	381399
02015201680	E 16	40	1	381405
02015201880	E 18	50	1	381412

2015-30

Einsteckringschlüssel für Keil- und Zahnriemenschlüssel

Chrom-Vanadium, C = verchromt

Ring wrench insert tool for universal V-belt and cam belt-wrench

Chrome-Vanadium, C = chromium plated

Attache polygonale mâle pour clé universelle pour tendeurs et courroie de distribution

Chrome-Vanadium, C = chromées

Bits para llaves universales para correas en V y dentadas

Cromo Vanadio, C = cromado



Code	MM	g	g	EAN
02015301280	12 x 14	60	1	381443
02015301380	13 x 15	60	1	381450
02015301680	16 x 17	80	1	381467
02015301880	18 x 19	80	1	381474

2145

Saugheber

ST = standardmäßig, 2 bewegliche Saugköpfe, speziell geeignet für gebogene Autoscheiben, Ansaugmechanik und Sicherheitsverriegelung, ideal zum Transportieren, Ein- und Ausheben von Windschutzscheiben, Türen, Blechen usw. (Empfehlung: paarweise verwenden).

Suction lifters



ST = standard, with 2 suction cups, suction mechanism with safety locking, ideal for lifting and transporting sheet metal, plastic sheets, glass panels, installation of windscreens, doors etc. (recommendation: to be used in pairs) movable suction cups particularly suitable for curved windscreens.

Ventouses doubles

ST = standard, avec 2 ventouses, système mécanique d'aspiration et blocage de sécurité, idéal pour transporter, monter et démonter des pare-brises, portes, tôles etc. (recommandation: à utiliser par paires).

Asas con ventosas

ST = estándar, 2 ventosas, mecanismo de vacío y cierre de seguridad, ideal para transportar, montar y desmontar cristales, parabrisas, puertas, chapas, etc. (recomendamos su uso por parejas).

Code	←L→ mm	Saugkopf suction cup Ø mm	Tragkraft capacity kg			EAN
02145000000	390	120	80	615	1	033021



PRÄSENTATIONSSYSTEME

PRESENTATION SYSTEMS

PRÄSENTATIONSSYSTEME

Einfache Montage, beeindruckende Warenpräsentation:
HEYCO-Verkaufswände sind auch ohne Aufbauanleitung einfach zu montieren.

Mit unseren Verkaufswänden erfüllen wir den gehobenen Anspruch vom Händler und Anwender. Die Verkaufswände lassen sich in beliebiger Anzahl aneinanderfügen und bieten somit eine übersichtliche Warenpräsentation. Wir sind gern bereit, im Rahmen einer kundenbezogenen Gestaltung von Verkaufs- oder Ausstellungswänden Sortimente zusammenzustellen, die den Kundenwünschen entsprechen, und sie individuell anzupassen.

HEYCO-Verkaufswände System „Tegometall“ entsprechen weitestgehend den handelsüblichen Wänden in Baumärkten etc. und können auf Wunsch auch in Schlüssellochung (SL) geliefert werden.

PRESENTATION SYSTEMS

Easy installation, impressive presentation of merchandise:
HEYCO tool bars can easily be assembled without instructions.

Our tool bar systems fulfil the particular needs of discerning dealers and users. The tool bars can be extended with any number of additional modules to create an impressive and clearly organised display of merchandise. For customer-specific tool bar concepts, we would be pleased to configure and supply systems adapted to the customer's specific requirements.

HEYCO-Tool bars system „Tegometall“ correspond extensively the commonly used display stands in builders markets and cash-and-carry places and on request also can be supplied with keyhole perforation.

SYSTÈMES DE PRÉSENTATION

Installation simple, une belle présentation des produits:
Les panneaux de vente muraux HEYCO peuvent être montés simplement et sans mode d'emploi.

Avec nos panneaux de vente muraux, nous répondons à toutes les attentes des commerçants et des utilisateurs. Il est possible d'assembler autant de panneaux qu'on le souhaite pour une présentation claire des produits. Nous nous ferons un plaisir de combiner nos produits en fonction des souhaits du client et de les personnaliser dans le cadre d'un aménagement individualisé des panneaux de vente et présentoirs muraux.

Les panneaux de vente HEYCO du système « Tegometall » correspondent largement à la plupart des panneaux muraux couramment utilisés dans les magasins de bricolage, etc. et sont également disponibles avec des découpes en trou de serrure.



SISTEMAS DE PRESENTACIÓN

Montaje sencillo, llamativa presentación de productos:
Los murales expositores de HEYCO son fáciles de montar incluso sin instrucciones.

Con nuestros murales expositores satisfacemos las expectativas de vendedores y usuarios. Los murales expositores pueden montarse en paralelo en la cantidad deseada, con lo que ofrecen una presentación clara y general de los productos. Estaremos encantados de preparar el surtido perfecto de murales expositores para la presentación de productos adaptada a las necesidades y los deseos del cliente.

El sistema de murales expositores de HEYCO "Tegometall" se corresponde en gran medida con las paredes estándar de las tiendas de bricolaje y similares y, si se desea, puede suministrarse perforado.



1170

Lochplatten-Verkaufswand System „Tegometall“

L = lackiert

(schlag- und kratzfest durch Kunststoff-Pulverbeschichtung)
aus 1,25 mm starkem Stahlblech, Rundlochung (RL), 5 einhängbare
Tafeln 1000 x 400 mm, davon 4 Tafeln gelocht, 3 glatte Ablage-
böden, 1 Einteilungs-Satz mit vorderer und hinterer Abteilschiene
und 20 Trennbleche sowie Preisschiene für mittleren oder oberen
Ablageboden, mittlerer und oberer Ablageboden schrägstellbar, mit
Bodenausgleichsfüßen und Beleuchtungseinheit.

Perforated tool bar system „Tegometall“

L = lacquered

(scratch- and shock resistant plastic coating)
made of 1,25 mm thick sheet steel, round hole perforation, 5
individual hang on boards 1000 x 400 mm for easy assembly, 4 of
which are perforated, 3 plain shelves, 1 set of sub-divisions consisting
of front- and rear division rails, 20 partitions and rail for price tags
for middle or upper shelf, middle and upper shelf can be tilted, with
adjustable pedestal and illumination.

Présentoirs perforés en tôle d'acier système „Tegometall“



L = laquées

(revêtement polymérisé, résistant aux chocs et éraflures),
forte tôle d'acier de 1,25 mm, perforées de trous ronds (RL), 5
plateaux à suspendre de 1000 x 400 mm, dont 4 perforés, 3
plateaux pleins, 1 jeu de séparation avec rails avant et arrière
pour compartiments et 20 plaquettes de séparation ainsi que des
rainures pour étiquetage des prix destinées aux plateaux centraux
et supérieurs, plateaux centraux et supérieurs inclinables, pieds
ajustables et enseigne lumineuse.

Expositores de chapa perforada Sistema „Tegometall“

L = pintado

(mediante recubrimiento con epoxy, resistente a golpes y raspados);
de chapa de acero de 1,25 mm de grosor; agujeros redondos (RL);
con 5 tableros de 1.000 x 400 mm, de ellos 4 con agujeros; 3
estantes lisos, un juego de separadores con listón delantero y trasero
y 20 separadores, además de listón para precios para los estantes
medio y superior, ambos inclinables; con pies compensadores y
cabezal de iluminación.

Code	tlg. pcs.			EAN
01170010020	40	68000	1	133837

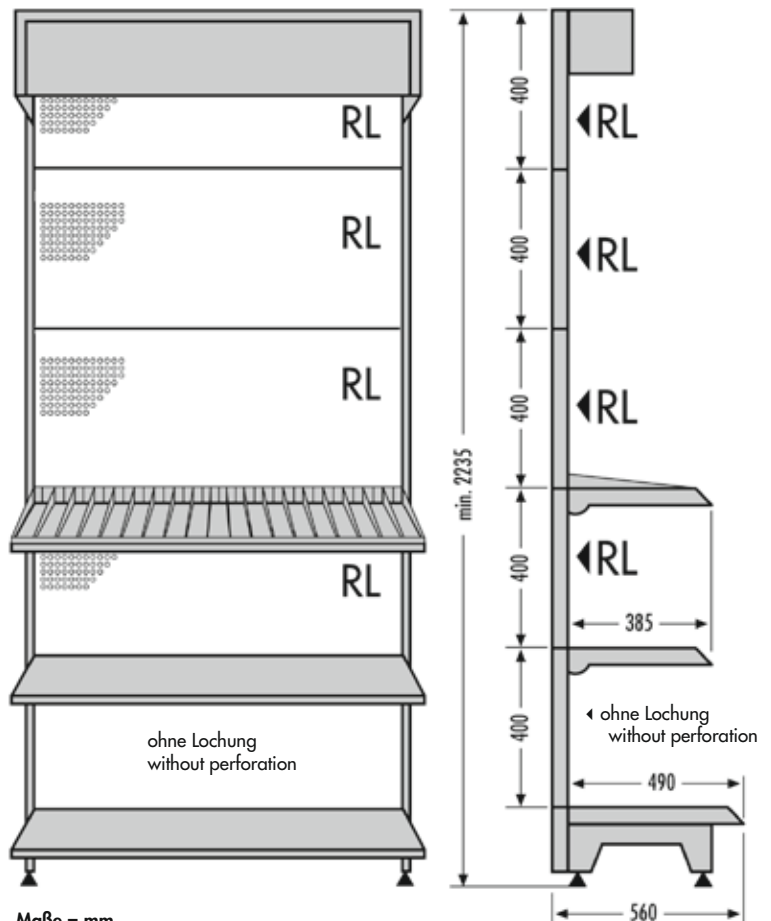
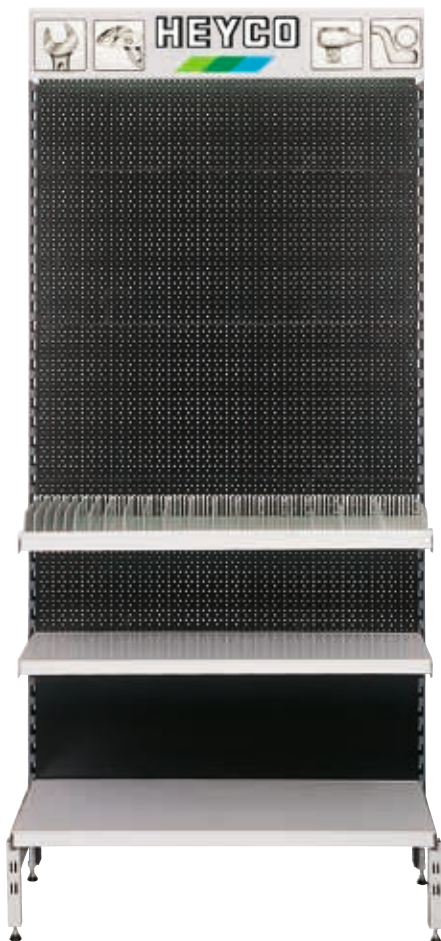

Maße = mm
Dimensions = mm
Medidas = mm

1171

Lochplatten-Verkaufswand System „Tegometall“

Innenecke 2 x 45° *

6 Fachböden, 8 Tafeln RL, 2 Tafeln glatt, 8 Konsolen, 1 Stütze, 1 Fußteil

Perforated tool bar system „Tegometall“

Inner corner 2 x 45° *

6 shelves, 8 boards with round hole perforation, 2 plain boards, 1 support, 1 pedestal

Présentoirs perforés en tôle d'acier système „Tegometall“

Coins intérieurs 2 x 45° *

6 supports de tablettes, 8 panneaux perforés RL, 2 panneaux pleins, 1 support, 1 socle

Expositores de chapa perforada Sistema „Tegometall“

Rincón 2 x 45° *

6 estantes, 8 tableros RL, 2 tableros lisos, 1 apoyo, 1 pie



Code	tlg. pcs.	g		EAN
01171010020	18	15000	1	144475

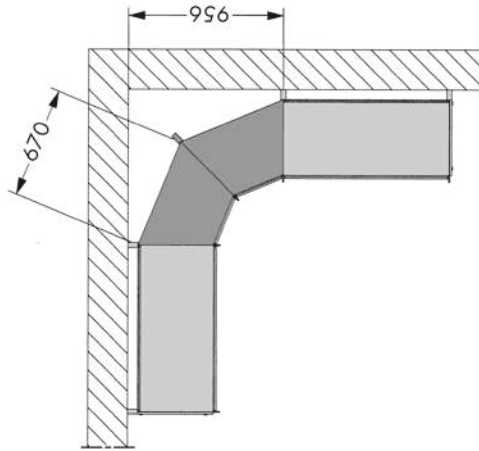

Maße = mm
Dimensions = mm
Medidas = mm

Beschreibung siehe HEYCO No. 1170

* als Anbaueinheit an bestehende Verkaufswände HEYCO No. 1170.

Description see HEYCO No. 1170

* as additional unit for existing display stands HEYCO No. 1170.

Voir HEYCO N° 1170 pour description

* pour adaptation aux présentoirs existants HEYCO No. 1170.

Véase descripción en ref. HEYCO 1170

* como complemento para expositores ref. HEYCO No. 1170.

1172

Lochplatten-Verkaufswand System „Tegometall“

Außenecke 90° *

3 Fachböden, 5 Tafeln glatt

Perforated tool bar system „Tegometall“

Outer corner 90° *

3 shelves, 5 plain boards

Présentoirs perforés en tôle d'acier système „Tegometall“

Coins extérieurs 90° *

3 supports de tablette, 5 panneaux pleins

Expositores de chapa perforada Sistema „Tegometall“

Esquina 90° *

3 estantes, 5 tableros lisos



Code	tlg. pcs.	g		EAN
01172010020	8	8000	1	144437

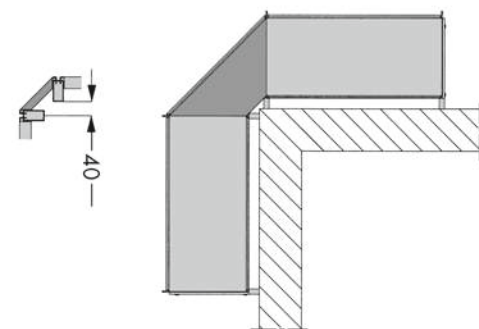

Maße = mm
Dimensions = mm
Medidas = mm

Beschreibung siehe HEYCO No. 1170

* als Anbaueinheit an bestehende Verkaufswände HEYCO No. 1170.

Description see HEYCO No. 1170

* as additional unit for existing display stands HEYCO No. 1170.

Voir HEYCO N° 1170 pour description

* pour adaptation aux présentoirs existants HEYCO No. 1170.

Véase descripción en ref. HEYCO 1170

* como complemento para expositores ref. HEYCO No. 1170.

1174

Lochplatten-Verkaufsständer System „Tegometall“
 3 Fachböden, 2 Tafeln glatt, 1 Tafel RL,
 1 Logotafel, 2 Fußteile, 2 Stützen, 2
 Sicherungsgitter, 4 Konsolen, Kopfabdeckungen

Perforated tool bar system „Tegometall“

3 shelves, 2 plain hangon boards, 1 hong on board with round hole perforation, 1 board with logo, 2 pedestals, 2 supports, 2 protection trellis, 4 consoles, covers

Présentoirs de vente perforés en tôle d'acier System „Tegometall“

3 plateaux à casiers, 2 plateaux pleins, 1 planneau perforé RL, 1 tableau de logos, 2 pieds, 2 supports, 2 grilles de sécurité, 4 consoles, bandeau supérieur

Expositor con paneles perforados Sistema „Tegometall“

3 bandejas, 2 paneles lisos, 1 panel RL, 1 panel con logotipo, 2 pies, 2 apoyos, 2 rejillas protectoras, 4 cónsolas, topes



Code	tlg. pcs.	Maße dimensions			EAN
01174010020	21	1450 x 700 x 560 mm	30000	1	310474



(Beschreibung siehe HEYCO No. 1170)

(Description see HEYCO No. 1170)

(Voir HEYCO No. 1170 pour description)

(Véase descripción en HEYCO 1170)

Zubehör

für Lochplattenwände HEYCO 1170, 1171, 1172, 1174

Accessories

for perforated tool bars HEYCO 1170, 1171, 1172, 1174

Accessoires

pour panneaux perforés HEYCO 1170, 1171, 1172, 1174

Accesorios

para expositores HEYCO 1170, 1171, 1172, 1174

1170-8-1 / 1170-8-2

Sockelblenden Frontabdeckung / Sockelblenden
 Seitenabdeckung

für Lochplattenwand 1170

L = lackiert, Stahlblech mit Gummileiste

Pedestal panel – front cover / Pedestal panel – side cover

for perforated tool bar 1170

L = lacquered, Sheet steel with rubber lip

Cache-socle de devant /Cache-socle de latéral

pour panneau perforé 1170

L = laquées, Tôle d'acier avec rebord en caoutchouc

zócalos frontales /zócalos laterales

para expositor 1170

L = barnizado, Chapa de acero con remate de caucho

Code	No.	Maße dimensions			EAN
01170800120	1170-8-1	1000 x 260 mm	2000	1	144604
01170800220	1170-8-2	55 x 260 mm	910	2	144598

1170-8-1



1170-8-2



1171-8-1

Sockelblenden Frontabdeckung

für Lochplattenwand 1171

L = lackiert, Stahlblech mit Gummileiste

Pedestal panel - front cover

for perforated tool bar 1171

L = lacquered, Sheet steel with rubber lip

Cache-socle de devant

pour panneau perforé 1171

L = laquées, Tôle d'acier avec rebord en caoutchouc

zócalos frontales

para expositor 1171

L = barnizado, Chapa de acero con remate de caucho



Code	Maße dimensions	 g		EAN
01171800120	320 x 260 mm	600	2	144574

1172-8-1

Sockelblenden Frontabdeckung

für Lochplattenwand 1172

L = lackiert, Stahlblech mit Gummileiste

Pedestal panel - front cover

for perforated tool bar 1172

L = lacquered, Sheet steel with rubber lip

Cache-socle de devant

pour panneau perforé 1172



L = laquées, Tôle d'acier avec rebord en caoutchouc

zócalos frontales

para expositor 1172

L = barnizado, Chapa de acero con remate de caucho



Code	Maße dimensions	 g		EAN
01172800120*	760 x 260 mm	1590	1	144567

1170-11 1174-11

Fußteilschubladen

für Lochplattenwände 1170 und 1174

L = lackiert, Stahlblech, mit Rollen,

für max. Belastung 120 kg (1170-11), 80 kg (1174-11)

Drawer for pedestal

for perforated tool bars 1170 and 1174

L = lacquered, Sheet steel with rollers,

for loads of max. 120 kg (1170-11), 80 kg (1174-11)

Tiroir de socle

pour panneaux perforés 1170 et 1174

L = laquées, Tôle d'acier, avec roulettes,

pour charge de 120 kg (1170-11), 80 kg (1174-11)



Cajón para parte inferior

para expositor 1170 y 1174

L = barnizado, Chapa de acero, con ruedas,

carga máxima admisible 120 kg (1170-11), 80 kg (1174-11)



Code	No.	Maße dimensions	 g		EAN
01170110020	1170-11	1000 x 180 x 470 mm	7125	1	144581
01174110020	1174-11	630 x 180 x 470 mm	4750	1	310719

Lochtafelhaken

für Lochplattenwände HEYCO 1170, 1171, 1174

Hooks

for perforated tool bars HEYCO 1170, 1171, 1174



Crochets

de tablettes perforées HEYCO 1170, 1171, 1174



Ganchos

para expositor HEYCO 1170, 1171, 1174



1176-1

Code		tlg. pcs.			EAN
01176000160	85 – 1177-1-1	115	4515	1	143102
	30 – 1179-1-1				

1176-2

Code		tlg. pcs.			EAN
01176000260	70 – 1177-1-2	175	7805	1	143119
	25 – 1177-1-5				
	20 – 1178-1-2				
	20 – 1178-1-5				
	40 – 1179-1-2				

1176-3

Code		tlg. pcs.			EAN
01176000360	20 – 1177-1-3	180	8500	1	143126
	20 – 1177-1-5				
	70 – 1178-1-3				
	70 – 1178-1-5				

1177-1-1 – 1177-2-4

Einfachklapphaken

Z = verzinkt Stahldraht

Single folding hooks



Z = zinc plated steel wire

Crochets rabattables simples

Z = galvanisé, bleu passivé. Fil d'acier

Ganchos plegables simples

Z = cincado, cromatizado azul Alambre de acero

Code	No.	←L→ mm	∅ mm			EAN
01177100160	1177-1-1	50	4,8	39	10	143010
01177100260	1177-1-2	120	4,8	49	10	143027
01177100360	1177-1-3	200	4,8	61	10	143034
01177200360	1177-2-3	200	5,9	115	10	310801
01177200460*	1177-2-4	250	5,9	125	10	310832



1177-1-1



1177-2-3

1177-1-5

Preisfahnen

St = standardmäßig, Kunststoff weiß, mit Metallschild für Einfachklapphaken

Price tags



St = standard, plastic, white, with metalplate for single folding hooks

Porte-étiquettes de prix

St = standard, Plastique blanc, avec plaquette métallique pour crochets rabattables simples

Etiquetas de precios

St = estándar, Plástico blanco, con escudo metálico, para ganchos plegables simples

Code	Beschriftungsfläche marking area mm	∅ mm			EAN
01177100500	27 x 42	4,8	7	10	143089



1178-1-2 - 1178-1-4

Doppelklapphaken

Z = verzinkt, Stahldraht

Double folding hooks

Z = zinc plated, steel wire

Crochets rabattables doubles

Z = galvanisé, bleu passivé, Fil d'acier

Ganchos plegables dobles

Z = cincado, cromatizado azul, Alambre de acero



Code	No.	←L→ mm	∅ mm	g		EAN
01178100260	1178-1-2	120	4,8	78	10	143041
01178100360	1178-1-3	200	4,8	100	10	143058
01178100460*	1178-1-4	300	4,8	128	10	310849

1178-1-5

Preisfahnen

St = standardmäßig, Kunststoff transparent

für Einfachklapphaken 1177-2-3 + 4

für Doppelklapphaken 1178-1-2 + 3 + 4

Price tags

St = standard, Plastic, transparent

for single folding hooks 1177-2-3 + 4

for double folding hooks 1178-1-2 + 3 + 4

Porte-étiquettes de prix

St = standard, Plastique transparent

pour crochets rabattables simples 1177-2-3 + 4

pour crochets rabattables doubles 1178-1-2 + 3 + 4

Etiquetas de precios

St = estándar, Plástico transparente

para ganchos plegables simples 1177-2-3 + 4

para ganchos plegables dobles 1178-1-2 + 3 + 4



Code	Beschriftungsfläche marking area mm	∅ mm	g		EAN
01178100500	27 x 42	4,8	2	10	143096

1179-1-1

Spezialhaken für Doppelmaulschlüssel

Z = verzinkt, Einzelhalter

Special hooks for double ended open jaw wrenches

Z = zinc plated, Single holder

Crochets spéciaux pour clés à fourche

Z = galvanisé, bleu passivé, Support à outils simple

Ganchos especiales para llaves abiertas de dos bocas

Z = cincado, cromatizado azul, Sujeción individual



Code	←L→ mm	∅ mm	g		EAN
01179100160	40	4,8	40	20	143065

Verwendung paarweise horizontal.

To be used horizontally in pairs.

Utilisation horizontale par paire.

Uso por pares, horizontal.

1179-1-2

Spezialhaken für Doppelmaulschlüssel

Z = verzinkt, 10-fach Halter

Special hooks for double ended open jaw wrenches

Z = zinc plated, 10-fold holder

Crochets spéciaux pour clés à fourche

Z = galvanisé, bleu passivé, Support pour 10 outils

Ganchos especiales para llaves abiertas de dos bocas

Z = cincado, cromatizado azul, Sujeción para 10 piezas



Code	←L→ mm	∅ mm	g		EAN
01179100260	130	4,8	65	20	143072

Verwendung paarweise horizontal.

To be used horizontally in pairs.

Utilisation horizontale par paire.

Uso por pares, horizontal.

INFORMATIONEN

INFORMATION

Vergleichstabelle metrischer, amerikanischer und britischer Maße für Schlüsselweiten und Gewindedurchmesser (Nennmaß = Bestellmaß)

Metrische Maße										Amerikanische Maße										Britische Maße																																																																																																																																																																																																																																																						
Schlüsselweiten				Ø-Gewinde						Schlüsselweiten			Ø-Gewinde							Ø-Gewinde		Schlüsselweiten																																																																																																																																																																																																																																																				
Nennmaß MM	Kleinmaß - mm nach DIN 475/2		Größmaß - mm nach DIN 475/2, Reihe 1		Größmaß - mm nach DIN 475/2, Reihe 2		metrische Maße nach DIN		ISO R272 1968		Nennmaß AF	dezimal - Zoll	dezimal - metrisch	ISO R 272 1962		Unified Standard		American Standard B 18.2 1972				Nennmaß BA BW	BS 916, BS 1083	dezimal - Zoll	dezimal - metrisch																																																																																																																																																																																																																																																	
	normaler Sechskant	kleiner Sechskant	großer Sechskant	normaler Sechskant	kleiner Sechskant	Bolts	Nuts	normal series BS 1768	heavy series BS 1769	finished thick series				regular square series	heavy series	Nuts		Bolts+Screws																																																																																																																																																																																																																																																								
3	3,2	3,5	3,02	3,22	3,52	3,08	3,28	3,60	1,2	1,4	1,6	1,7																																																																																																																																																																																																																																																														
4	4,5	5	4,02	4,52	5,02	4,12	4,62	5,12	2	2,3	2,5	2,6																																																																																																																																																																																																																																																														
5,5	6		5,52	6,03		5,62	6,15		3	3,5																																																																																																																																																																																																																																																																
7	8		7,03	8,03		7,15	8,15	8,18	4	5	6																																																																																																																																																																																																																																																															
9	10		9,03	10,04		9,15	10,19	10,24	6	8																																																																																																																																																																																																																																																																
11	12	13	11,04	12,04	13,04	11,19	12,24	13,24	7	8	10																																																																																																																																																																																																																																																															
14	15	16	14,05	15,05	16,05	14,27	15,27	16,27	10	(KFZ)																																																																																																																																																																																																																																																																
17	18	19	17,05	18,05	19,06	17,30	18,30	19,36	10	12	12	14																																																																																																																																																																																																																																																														
20	20,8	21	20,06	20,86	21,06	20,36	21,16	21,36																																																																																																																																																																																																																																																																		
22	23	24	22,06	23,06	24,06	22,36	23,36	24,46	14		12	14	16																																																																																																																																																																																																																																																													
25	26	27	25,06	26,08	27,08	25,36	26,48	27,58	18		16	18	20																																																																																																																																																																																																																																																													
28	29	30	28,08	29,08	30,08	28,48	29,48	30,58	20	24																																																																																																																																																																																																																																																																
32	33	36	32,08	33,08	36,10	32,48	33,48	36,70	22		20	22	24																																																																																																																																																																																																																																																													
38	41	42	38,10	41,10	42,10	38,60	41,60	42,70	27		24	27	30																																																																																																																																																																																																																																																													
46			46,10			46,60			30	36	27	30	33																																																																																																																																																																																																																																																													
1/8	5/32	3/16	.1250	.1563	.1875	.2031	.2188	.2344	.2500	.2656	.2813	.3125	.3438	.3750	.4062	.4375	.5000	.5313	.5625	.5938	.6250	.6563	.6875	.7500	.7813	.8125	.8750	.9375	.9688	1.0000	1.0625	1.1250	1.1875	1.2500	1.3125	1.3750	1.4375	1.5000	1.6250	1.6875	1.7500	1.8125	1.8750																																																																																																																																																																																																																															
No. 2	No. 3, 4, 5	No. 6, 8	No. 10, 12	No. 14, 16	No. 18, 20	No. 22, 24	No. 27, 30	No. 32, 36	No. 40, 45	No. 48, 54	No. 60, 66	No. 72, 81	No. 90, 100	No. 120, 135	No. 150, 180	No. 216, 252	No. 288, 324	No. 360, 405	No. 480, 540	No. 600, 675	No. 720, 810	No. 900, 1008	No. 1080, 1260	No. 1512, 1710	No. 1800, 2025	No. 2160, 2430	No. 2700, 3060	No. 3240, 3645	No. 3960, 4536	No. 4860, 5508	No. 5940, 6726	No. 7290, 8208	No. 8910, 10044	No. 10800, 12312	No. 13230, 15015	No. 16200, 18270	No. 19800, 22440	No. 24300, 27540	No. 29700, 33660	No. 36450, 41265	No. 44880, 50844	No. 54960, 62616	No. 67200, 76440	No. 82800, 94080	No. 101640, 115488	No. 124560, 141816	No. 154320, 174840	No. 190440, 216444	No. 238080, 270744	No. 292320, 333060	No. 356160, 402480	No. 433440, 492840	No. 529440, 600240	No. 648000, 737400	No. 792000, 899400	No. 974400, 1104600	No. 1191600, 1351140	No. 1453200, 1647180	No. 1771200, 1999440	No. 2157600, 2449680	No. 2630400, 2970360	No. 3211200, 3634440	No. 3924000, 4444800	No. 4790400, 5444400	No. 5841600, 6644400	No. 7094400, 8014800	No. 8688000, 9844800	No. 10668000, 12164400	No. 13008000, 14844000	No. 15852000, 18044400	No. 19344000, 21944400	No. 23664000, 26944800	No. 28944000, 33044400	No. 35344000, 39844800	No. 43056000, 48844800	No. 52368000, 59344800	No. 63600000, 71844000	No. 77376000, 87644400	No. 94224000, 106844400	No. 114816000, 129444000	No. 139776000, 156444000	No. 169824000, 190440000	No. 205776000, 231444000	No. 248640000, 280444000	No. 300480000, 339444000	No. 362880000, 409440000	No. 438240000, 494448000	No. 529440000, 594444000	No. 639600000, 719444000	No. 784800000, 884448000	No. 951360000, 1074444000	No. 1156800000, 1294440000	No. 1407360000, 1574440000	No. 1712640000, 1924440000	No. 2083200000, 2344440000	No. 2529600000, 2844440000	No. 3062400000, 3444440000	No. 3693600000, 4144440000	No. 4435200000, 5044440000	No. 5390400000, 6044440000	No. 6576000000, 7444440000	No. 7992000000, 8944440000	No. 9657600000, 10944400000	No. 11688000000, 13144400000	No. 14193600000, 15944400000	No. 17208000000, 19344400000	No. 20868000000, 23544400000	No. 25232000000, 28444400000	No. 30464000000, 34444400000	No. 36648000000, 41444400000	No. 43968000000, 49444400000	No. 52608000000, 59444400000	No. 62816000000, 71444400000	No. 75840000000, 85444400000	No. 91920000000, 103444000000	No. 111480000000, 125444000000	No. 135024000000, 151444000000	No. 163104000000, 182444000000	No. 196224000000, 221444000000	No. 235080000000, 264444000000	No. 280440000000, 314444000000	No. 333120000000, 374444000000	No. 394080000000, 444444000000	No. 473440000000, 534444000000	No. 572640000000, 644444000000	No. 693360000000, 774444000000	No. 837600000000, 934444000000	No. 1008000000000, 1124440000000	No. 1216800000000, 1364440000000	No. 1468800000000, 1644440000000	No. 1771200000000, 1974440000000	No. 2132400000000, 2394440000000	No. 2553600000000, 2844440000000	No. 3046400000000, 3444440000000	No. 3624000000000, 4044440000000	No. 4296000000000, 4744440000000	No. 5073600000000, 5544440000000	No. 5976000000000, 6644440000000	No. 7022400000000, 7844440000000	No. 8342400000000, 9344440000000	No. 9960000000000, 11044400000000	No. 11916000000000, 13244400000000	No. 14256000000000, 15744400000000	No. 17040000000000, 18844400000000	No. 20328000000000, 22444400000000	No. 24192000000000, 27044400000000	No. 28608000000000, 31844400000000	No. 33648000000000, 37444400000000	No. 39408000000000, 43444400000000	No. 45984000000000, 50444400000000	No. 53472000000000, 58444400000000	No. 61968000000000, 67444400000000	No. 71592000000000, 78444400000000	No. 82464000000000, 90444400000000	No. 94704000000000, 104444000000000	No. 108432000000000, 119444000000000	No. 123696000000000, 136444000000000	No. 140640000000000, 154444000000000	No. 159520000000000, 174444000000000	No. 180480000000000, 196444000000000	No. 203680000000000, 221444000000000	No. 229280000000000, 249444000000000	No. 257440000000000, 279444000000000	No. 288320000000000, 311444000000000	No. 322080000000000, 346444000000000	No. 359840000000000, 384444000000000	No. 401760000000000, 424444000000000	No. 448000000000000, 464444000000000	No. 498720000000000, 504444000000000	No. 554080000000000, 544444000000000	No. 615360000000000, 584444000000000	No. 682720000000000, 624444000000000	No. 756480000000000, 664444000000000	No. 836960000000000, 704444000000000	No. 924640000000000, 744444000000000	No. 1019840000000000, 784444000000000	No. 1122960000000000, 824444000000000	No. 1234400000000000, 864444000000000	No. 1353600000000000, 904444000000000	No. 1481280000000000, 944444000000000	No. 1618080000000000, 984444000000000	No. 1772640000000000, 1024440000000000	No. 1936480000000000, 1064440000000000	No. 2110240000000000, 1104440000000000	No. 2294400000000000, 1144440000000000	No. 2489600000000000, 1184440000000000	No. 2696800000000000, 1224440000000000	No. 2916400000000000, 1264440000000000	No. 3150080000000000, 1304440000000000	No. 3397600000000000, 1344440000000000	No. 3659040000000000, 1384440000000000	No. 3934880000000000, 1424440000000000	No. 4225760000000000, 1464440000000000	No. 4533120000000000, 1504440000000000	No. 4846720000000000, 1544440000000000	No. 5177280000000000, 1584440000000000	No. 5525440000000000, 1624440000000000	No. 5891840000000000, 1664440000000000	No. 6276160000000000, 1704440000000000	No. 6679040000000000, 1744440000000000	No. 7099840000000000, 1784440000000000	No. 7539120000000000, 1824440000000000	No. 8007360000000000, 1864440000000000	No. 8494240000000000, 1904440000000000	No. 9000480000000000, 1944440000000000	No. 9526560000000000, 1984440000000000	No. 10083200000000000, 2024440000000000	No. 10660960000000000, 2064440000000000	No. 11270400000000000, 2104440000000000	No. 11898400000000000, 2144440000000000	No. 12556800000000000, 2184440000000000	No. 13252800000000000, 2224440000000000	No. 13988800000000000, 2264440000000000	No. 14715360000000000, 2304440000000000	No. 15492960000000000, 2344440000000000	No. 16310400000000000, 2384440000000000	No. 17150400000000000, 2424440000000000	No. 18022400000000000, 2464440000000000	No. 18926400000000000, 2504440000000000	No. 19862400000000000, 2544440000000000	No. 20840000000000000, 2584440000000000	No. 21850400000000000, 2624440000000000	No. 22891200000000000, 2664440000000000	No. 23973600000000000, 2704440000000000	No. 25088000000000000, 2744440000000000	No. 26236800000000000, 2784440000000000	No. 27429600000000000, 2824440000000000	No. 28656000000000000, 2864440000000000	No. 29918400000000000, 2904440000000000	No. 31240000000000000, 2944440000000000	No. 32457600000000000, 2984440000000000	No. 33696000000000000, 3024440000000000	No. 35078400000000000, 3064440000000000	No. 36494400000000000, 3104440000000000	No. 37929600000000000, 3144440000000000	No. 39417600000000000, 3184440000000000	No. 40944000000000000, 3224440000000000	No. 42508800000000000, 3264440000000000	No. 44169600000000000, 3304440000000000	No. 45926400000000000, 3344440000000000	No. 47812800000000000, 3384440000000000	No. 49734400000000000, 3424440000000000	No. 51768000000000000, 3464440000000000	No. 53832000000000000, 3504440000000000	No. 55929600000000000, 3544440000000000	No. 58056000000000000, 3584440000000000	No. 60216000000000000, 3624440000000000	No. 62496000000000000, 3664440000000000	No. 64800000000000000, 3704440000000000	No. 67233600000000000, 3744440000000000	No. 69700800000000000, 3784440000000000	No. 72208000000000000, 3824440000000000	No. 74750400000000000, 3864440000000000	No. 77331200000000000, 3904440000000000	No. 80046400000000000, 3944440000000000	No. 82790400000000000, 3984440000000000	No. 85568000000000000, 4024440000000000	No. 88484800000000000, 4064440000000000	No. 91435200000000000, 4104440000000000	No. 94524800000000000, 4144440000000000	No. 97657600000000000, 4184440000000000	No. 100928000000000000, 4224440000000000	No. 104342400000000000, 4264440000000000	No. 107896000000000000, 4304440000000000	No. 111584000000000000, 4344440000000000	No. 11541120000000000

Comparison Table of Metric, American and British Sizes for Spanner Openings and Thread Diameters (Nominal Size = Size to be ordered)

Metric Sizes										American Sizes										British Sizes			
Spanner Openings				Ø-Thread						Spanner Openings			Ø-Thread							Ø Thread		Spanner Openings	
Nominal Size Ø	Minimum size - mm to DIN 47/52/2	Maximum size - mm to DIN 47/52, row 1	Maximum size - mm to DIN 47/52, row 2	metric sizes to DIN			ISO R 272 1968	Nominal Size Ø	decimal - inch	decimal - metric	Belts	Nuts	ISO R 272 1962	Unified Standard	American Standard B 18.2 - 1972		Nuts	Bolts / Screws		Nominal Size Ø	BS 916, BS 1089	decimal - inch	decimal - metric
				standard hexagon	small hexagon	large hexagon	standard hexagon								small hexagon	regular square series		heavy series	finished and regular ball series, hex. hex. cap screws				
3	3,02	3,08		1,2	1,4			1/8	.1250	3,18	No. 2									10 BA		.117	2,97
3,2	3,22	3,28		1,6																9 BA		.131	3,32
3,5	3,57	3,60		1,7																			
4	4,07	4,17		2,3																			
4,5	4,52	4,62		2,3																			
5	5,02	5,12		2,5	2,6																		
5,5	5,52	5,62		3																			
6	6,03	6,15		3,5																			
7	7,03	7,16		4																			
8	8,03	8,16	8,18	5	6																		
9	9,03	9,16	9,18																				
10	10,04	10,19	10,24	6	8																		
11	11,04	11,19	11,24	7																			
12	12,04	12,24	12,30																				
13	13,04	13,24	13,30	8	10																		
14	14,05	14,27	14,35	10																			
15	15,05	15,27	15,35	10																			
16	16,05	16,27	16,35	10																			
17	17,05	17,30	17,40	10	12																		
18	18,05	18,30	18,40																				
19	19,06	19,26	19,46	12	14																		
20	20,06	20,36	20,46																				
20,8	20,86	21,16	21,26																				
21	21,06	21,36	21,46																				
22	22,06	22,36	22,46	14																			
23	23,06	23,36	23,46																				
24	24,06	24,36	24,46	16	20																		
25	25,06	25,36	25,46																				
26	26,06	26,48	26,58																				
27	27,06	27,48	27,58	18		16																	
28	28,06	28,48	28,58																				
29	29,06	29,48	29,58																				
30	30,06	30,48	30,58	20	24																		
32	32,06	32,48	32,58	22		20																	
33	33,06	33,48	33,58																				
34	34,06	34,48	34,58	24	30	22	24	27															
38	38,10	38,60	38,70																				
41	41,10	41,60	41,70	27		24	27	30															
42	42,10	42,60	42,70																				
46	46,10	46,60	46,70	30	36	27	30	33															
50	50,10	50,60	50,70	33			33	36															
54	54,10	54,60	54,70																				
55	55,12	55,72	55,92	36	42		36	39															
58	58,12	58,72	58,92																				
60	60,12	60,72	60,92	39			39																
63	63,12	63,72	63,92																				
65	65,12	65,72	65,92	42	48		42																
67	67,12	67,72	67,92																				
70	70,12	70,72	70,92	45			45																
71	71,12	71,72	71,92																				
75	75,15	75,85	76,15	48	56		48																
77	77,15	77,85	78,15																				
80	80,15	80,85	81,15	52			52																
85	85,15	85,85	86,15	56			56																
90	90,15	90,85	91,15	60			60																
95	95,15	95,85	96,15	64			64																
100	100,15	100,85	101,15	68			68																

Comparison Table of Metric, American and British Sizes for Spanner Openings and Thread Diameters (Nominal Size = Size to be ordered)

Metric Sizes							American Sizes										British Sizes							
Spanner Openings				Ø-Thread			Spanner Openings			Ø-Thread							Ø Thread		Spanner Openings					
Nominal Size 	minimum size - mm to DIN 974/1	maximum size - mm to DIN 974/1, 2nd 1	maximum size - mm to DIN 974/1, 2nd 2	metric size to DIN		ISO R272 1968	Nominal Size 	decimal - inch	decimal - metric	ISO R 272 1962		Unified Standard		American Standard B 1B.2 1972				Nominal Size 	BS 916, BS 1085	nominal - inch	nominal - metric			
				standard hexagon	small hexagon	large hexagon				standard hexagon	small hexagon	Bolts	Nuts	regular series BS 1768	heavy series BS 1769	Nuts						Bolts & Screws		
105	105,20	106,00	106,40	72		72	4.1/8	4.1250	104,77															
110	110,20	111,00	111,40	76		76	4.1/4	4.2500	107,95															
115	115,20	116,00	116,40	80		80	4.1/2	4.5000	114,30															
120	120,20	121,00	121,40	85		85	4.5/8	4.6250	117,47															
125	125,20	126,00	126,40				4.7/8	4.8750	123,82															
							5	5.0000	127,00															
130	130,20	131,00	131,40	90		90	5.1/4	5.2500	133,35															
135	135,20	136,00	136,40	95		95	5.3/8	5.3750	136,52															
140	140,20	141,00	141,40				5.5/8	5.6250	142,87															
145	145,20	146,00	146,40	100		100	5.3/4	5.7500	146,85															
150	150,25	151,25		105		105	6	6.0000	152,40															
155	155,25	156,25		110		110	6.1/8	6.1250	155,57															
160	160,25	161,25																						
165	165,25	166,25																						
170	170,25	171,25																						
175	175,25	176,25																						
180	180,25	181,25																						
185	185,25	186,25																						
190	190,25	191,25																						
195	195,25	196,25																						
200	200,25	201,25																						
210	210,25	211,25																						
220	220,30	221,50																						
230	230,30	231,50																						

Umrechnungstabelle – Zoll in mm

1 Zoll = 25,3995 mm

Conversion Table – Inches to Millimetres

1 inch = 25,3995 mm

Zoll	1"	2"	3"	4"	5"	6"	7"	8"	9"	10"	11"	12"	13"	14"	15"	Zoll	
1/64	mm	25,3995	50,7990	76,1986	101,598	126,998	152,397	177,797	203,196	228,596	253,995	279,395	304,794	330,194	355,594	380,994	1/64
1/32	0,3968	25,7964	51,1959	76,5954	101,995	127,394	152,794	178,193	203,593	228,992	254,392	279,792	305,191	330,591	355,991	381,391	1/32
3/64	0,7937	26,1932	51,5928	76,9923	102,391	127,791	153,190	178,590	203,990	229,389	254,789	280,189	305,588	330,988	356,388	381,788	3/64
1/16	1,1906	26,5901	51,9896	77,3892	102,788	128,188	153,588	178,987	204,386	229,786	255,186	280,586	305,985	331,385	356,785	382,185	1/16
5/64	1,5874	26,9870	52,3865	77,7860	103,185	128,585	153,984	179,384	204,783	230,183	255,582	280,982	306,381	331,781	357,181	382,581	5/64
3/32	1,9843	27,3838	52,7834	78,1829	103,582	128,982	154,381	179,781	205,180	230,580	255,979	281,379	306,778	332,178	357,578	382,978	3/32
7/64	2,3812	27,7807	53,1802	78,5798	103,979	129,378	154,778	180,177	205,577	230,977	256,376	281,776	307,175	332,575	357,975	383,375	7/64
1/8	2,7780	28,1776	53,5771	78,9766	104,376	129,775	155,175	180,574	205,974	231,373	256,773	282,173	307,572	332,972	358,372	383,772	1/8
	3,1749	28,5744	53,9740	79,3735	104,773	130,172	155,572	180,971	206,370	231,770	257,170	282,570	307,969	333,369	358,769	384,169	
9/64	3,5718	28,9713	54,3708	79,7704	105,169	130,569	155,969	181,368	206,768	232,167	257,567	282,967	308,366	333,766	359,166	384,566	9/64
5/32	3,9686	29,3682	54,7677	80,1672	105,566	130,966	156,365	181,765	207,164	232,564	257,964	283,364	308,763	334,163	359,563	384,963	5/32
11/64	4,3655	29,7650	55,1646	80,5641	105,963	131,363	156,762	182,162	207,561	232,961	258,360	283,760	309,160	334,560	359,960	385,360	11/64
3/16	4,7624	30,1619	55,5614	80,9610	106,360	131,760	157,159	182,559	207,958	233,358	258,757	284,157	309,556	334,956	360,356	385,756	3/16
13/64	5,1592	30,5588	55,9583	81,3579	106,757	132,156	157,556	182,956	208,355	233,755	259,154	284,554	309,953	335,353	360,753	386,153	13/64
7/32	5,5561	30,9556	56,3552	81,7547	107,154	132,553	157,953	183,352	208,752	234,152	259,551	284,951	310,350	335,750	361,150	386,550	7/32
15/64	5,9530	31,3525	56,7520	82,1516	107,551	132,950	158,350	183,749	209,149	234,548	259,948	285,348	310,747	336,147	361,547	386,947	15/64
1/4	6,3498	31,7494	57,1489	82,5485	107,948	133,347	158,747	184,146	209,546	234,945	260,345	285,745	311,144	336,544	361,944	387,344	1/4
17/64	6,7467	32,1462	57,5458	82,9453	108,344	133,744	159,143	184,543	209,943	235,342	260,742	286,142	311,541	336,941	362,341	387,741	17/64
9/32	7,1436	32,5431	57,9426	83,3422	108,741	134,141	159,540	184,940	210,339	235,739	261,139	286,539	311,938	337,338	362,738	388,138	9/32
19/64	7,5404	32,9400	58,3395	83,7291	109,138	134,538	159,937	185,337	210,736	236,136	261,536	286,935	312,334	337,734	363,134	388,534	19/64
5/16	7,9373	33,3368	58,7364	84,1359	109,535	134,935	160,334	185,734	211,133	236,532	261,932	287,332	312,731	338,131	363,531	388,931	5/16
21/64	8,3342	33,7337	59,1333	84,5328	109,932	135,331	160,731	186,131	211,530	236,930	262,329	287,729	313,128	338,528	363,928	389,328	21/64
11/32	8,7310	34,1306	59,5301	84,9297	110,329	135,728	161,128	186,527	211,927	237,326	262,726	288,126	313,525	338,925	364,325	389,725	11/32
23/64	9,1279	34,5274	59,9270	85,3265	110,726	136,125	161,525	186,924	212,324	237,723	263,123	288,523	313,922	339,322	364,722	390,122	23/64
3/8	9,5248	34,9243	60,3239	85,7234	111,122	136,522	161,925	187,321	212,721	238,120	263,520	288,920	314,319	339,719	365,119	390,519	3/8
25/64	9,9217	35,3212	60,7207	86,1203	111,529	136,919	162,318	187,718	213,118	238,517	263,917	289,317	314,716	340,116	365,516	390,916	25/64
13/32	10,3185	35,7180	61,1176	86,5171	111,916	137,316	162,715	188,115	213,514	238,914	264,313	289,712	315,113	340,513	365,913	391,313	13/32
27/64	10,7154	36,1149	61,5145	86,9140	112,313	137,713	163,112	188,512	213,911	239,311	264,710	290,110	315,509	340,909	366,309	391,709	27/64
7/16	11,1122	36,5118	61,9113	87,3109	112,710	138,109	163,509	188,909	214,308	239,708	265,107	290,507	315,906	341,306	366,706	392,106	7/16
29/64	11,5091	36,9087	62,3082	87,7077	113,107	138,506	163,906	189,305	214,705	240,105	265,504	290,904	316,303	341,703	367,103	392,503	29/64
15/32	11,9060	37,3055	62,7051	88,1046	113,504	138,903	164,303	189,702	215,102	240,501	265,901	291,301	316,700	342,100	367,500	392,900	15/32
31/64	12,3029	37,7024	63,1019	88,5015	113,901	139,300	164,700	190,099	215,499	240,898	266,298	291,698	317,097	342,497	367,897	393,297	31/64
1/2	12,6997	38,0993	63,4988	88,8983	114,297	139,697	165,097	190,496	215,896	241,295	266,695	292,095	317,494	342,894	368,294	393,694	1/2
33/64	13,0966	38,4951	63,8957	89,2952	114,694	140,094	165,493	190,893	216,292	241,692	267,092	292,492	317,891	343,291	368,691	394,091	33/64
17/32	13,4934	38,8930	64,2925	89,6921	115,091	140,491	165,890	191,290	216,689	242,089	267,488	292,888	318,287	343,687	369,087	394,487	17/32
35/64	13,8903	39,2899	64,6894	90,0899	115,489	140,888	166,287	191,687	217,086	242,486	267,885	293,285	318,684	344,084	369,484	394,884	35/64
9/16	14,2872	39,6867	65,0863	90,4858	115,885	141,284	166,684	192,084	217,483	242,883	268,282	293,682	319,081	344,481	369,881	395,281	9/16
37/64	14,6841	40,0836	65,4831	90,8827	116,282	141,681	167,081	192,480	217,880	243,279	268,679	294,079	319,478	344,878	370,278	395,678	37/64
19/32	15,0809	40,4805	65,8800	91,2795	116,679	142,078	167,478	192,877	218,277	243,676	269,076	294,476	319,875	345,275	370,675	396,075	19/32
39/64	15,4778	40,8773	66,2769	91,6764	117,075	142,475	167,875	193,274	218,674	244,073	269,473	294,873	320,272	345,672	371,072	396,472	39/64
5/8	15,8747	41,2742	66,6739	92,0733	117,472	142,872	168,271	193,671	219,071	244,470	269,870	295,270	320,669	346,069	371,469	396,869	5/8
41/64	16,2715	41,6711	67,0706	92,4701	117,869	143,269	168,668	194,068	219,467	244,867	270,266	295,666	321,066	346,466	371,866	397,266	41/64
21/32	16,6684	42,0679	67,4675	92,8670	118,266	143,666	169,065	194,464	219,864	245,263	270,663	296,063	321,462	346,862	372,262	397,662	21/32
43/64	17,0653	42,4648	67,8643	93,2639	118,663	144,063	169,462	194,862	220,261	245,661	271,061	296,460	321,859	347,259	372,659	398,059	43/64
11/16	17,4621	42,8617	68,2612	93,6608	119,060	144,459	169,859	195,258	220,658	246,058	271,457	296,857	322,256	347,656	373,056	398,456	11/16
45/64	17,8590	43,2585	68,6581	94,0576	119,457	144,856	170,256	195,655	221,055	246,454	271,854	297,254	322,653	348,053	373,453	398,853	45/64
23/32	18,2559	43,6554	69,0549	94,4545	119,854	145,253	170,653	196,052	221,452	246,851	272,251	297,651	323,050	348,450	373,850	399,250	23/32
47/64	18,6527	44,0523	69,4518	94,8513	120,250	145,650	171,050	196,449	221,849	247,248	272,648	298,048	323,447	348,847	374,247	399,647	47/64
3/4	19,0496	44,4491	69,8487	95,2482	120,647	146,047	171,446	196,846	222,245	247,645	273,045	298,445	323,844	349,244	374,644	400,044	3/4
49/64	19,4465	44,8460	70,2455	95,6451	121,044	146,444	171,843	197,243	222,642	248,042	273,441	298,841	324,241	349,641	375,041	400,441	49/64
25/32	19,8433	45,2429	70,6424	96,0419	121,441	146,841	172,240	197,640	223,039	248,439	273,838	299,238	324,637	350,037	375,437	400,837	25/32
51/64	20,2402	45,639															



Hauptsitz/Head office:
HEYCO-WERK Heynen GmbH & Co. KG, Remscheid

TRADITION TRIFFT FORTSCHRITT TRADITION MEETS INNOVATION



Administrative HEYCO-Ident-Nummern/Administrative HEYCO-Identification-Numbers HEYCO Qualitätswerkzeuge GmbH & Co. KG:

UST.-IdNr./VAT Reg. Number	: DE 3076 04891	
BIC	: COBADEFFXXX	
IBAN	: DE 84 3404 0049 0762 0560 00	
DUNS-Nr.	: HEYCO-WERK Remscheid Birgden	315941872
	: HEYCO-WERK Remscheid Bergisch Born	333601545
	: HEYCO-WERK SÜD Tittling, Werkzeuge/Tools	498994722
	: HEYCO-WERK SÜD Tittling, Kunststoff/Plastic	314327891
	: HEYCO-WERK Ballina, Irland	219662723
	: HEYCO-WERK Pisek, Tschechien	366947856
	: HEYCO-WERK Emporia, USA	116984678
	: HEYCO-WERK Greenville, USA	080433961

Nummernverzeichnis Numerical Index

HEYCO-No.		HEYCO-No.		HEYCO-No.		HEYCO-No.		HEYCO-No.	
1000	116	1171	245	1405	177	1577-600	204	2010	235
100-00-6	75	1171-8-1	247	1411	178	1577-800	204	2011	236
100-01-1	75	1172	245	1412	178	1578	214	2012	236
100-03-1	75	1172-8-1	247	1415	179	1610	214	2013	237
100-04	75	1174	246	1417	179	1615	215	2014	238
100-05	75	1174-11	247	1419	188	1616	215	2015	238
100-06	75	1176-1	248	1420	188	1617	215	2015-20	240
1000-914-M	103	1176-2	248	1424	188	1621-1	215	2015-30	240
1000-915-M	103	1176-3	248	1425	189	1621-2	215	2015-500	240
100-12	76	1177-1	248	1426	189	1621-3	215	2145	241
100-14	75	1177-2	248	1427	189	1622-1	216	2165	208
100-15	75	1178-1	249	1430	179	1622-2	216	2166	208
100-16	75	1179-1	249	1435	180	1626	216	25-00-15	34
1002	116	1200	149	1436	180	1640	217	25-03	34
1002-910-AF	103	1206	150	1437	180	1640-1	217	25-04	34
1002-910-M	103	1207	150	1445	181	1641	217	25-05	34
100-31	77	1208	151	1450	185	1641-1	217	25-05-1	34
100-6	76	1209	151	1452	182	1642	217	25-05-5	34
101-0-M	77	1212	152	1454	182	1642-1	217	25-06	34
101-10-AF	77	1213	152	1456	182	1643	217	25-07	35
101-30-M	77	1215	153	1458	182	1643-1	217	25-08	35
101-50-M	77	1220	153	1460	182	1659	218	25-11	35
101-60-AF	77	1230	159	1470	181	1660	218	25-15	35
101-80-M	77	1232	159	1471	183	1661	218	25-19	36
103	204	1233	159	1472	183	1662	218	25-20	36
105-00-6	78	1250	160	1479	189	1663	219	25-30	37
105-03	78	1252	160	1480	190	1665	220	25-31	37
105-04	78	1255	161	1483	190	1667	220	25-32	37
105-05	78	1256	161	1484	190	1668	221	25-35	37
105-12	79	1258	162	1491	190	1669	221	25-36	37
105-14	78	1261	163	1494-1	191	1670-M	221	25-50-E/T	39
1054	186	1261-1	163	1494-2	191	1670-UNF (NF)	221	25-6	35
1054-14	158	1261-30	162	1494-3	191	1675	222	25-6-M	38
106-0-M	79	1261-31	162	1495-3	191	1676	222	2-67-5001-M	67
1090	145	1261-32	163	1496-2	191	1677	222	2-67-5002-M	67
1090-1	145	1261-40	162	1497	191	1678	222	2-67-50-M	66
1101	116	1261-41	162	1500	204	1679	222	2-67-8001-M	67
1101-911-AF	103	1261-42	163	1505	204	1681-10	222	2-67-80-M	66
1101-911-M	103	1261-50	162	1509	204	1681-20	222	27-3010-M	39
1127-1	120	1261-51	162	1512	205	1681-30	222	27-3510-M	40
1127-2	120	1261-52	163	1513	205	1681-40	222	27-4010-AF	39
1127-3	121	1261-60	162	1520	206	1686	222	29-3010-M	40
1127-3-3	128	1261-61	162	1522	206	1686-1	222	300	148
1128	121	1261-62	163	1523	206	1689	223	30-3010-M	41
1128-1-8	129	1262-10	164	1530	207	1702-1	223	31-1910-M	41
1128-21	131	1262-24-1	164	1531	207	1702-2	223	313	148
1128-22	131	1262-24-2	164	1540-1	207	1702-3	223	316	149
1128-23	132	1262-32-1	164	1550	209	1721-1	226	3301-1	38
1128-3	129	1262-32-2	164	1551	209	1721-2	227	3305	81
1128-8-15	124	1262-40-1	164	1555	210	1721-3	226	3310	81
1128-8-5	124	1262-40-2	164	1555-1	210	1731	228	350	10
1128-8-9	124	1262-48-1	164	1556	210	1731-1	228	380	15
1128-933-AF	103	1262-48-2	164	1557	210	1754	229	390	15
1128-933-M	103	1280-L	165	1557-1	210	1755	229	400	19
1128-942-AF	103	1280-N	165	1558	211	1757	229	40-00-10	42
1128-942-M	103	1281	165	1558-1	211	1759	229	40-00-15	42
1128-943-AF	103	1282	165	1560	211	1781	230	40-00-27	42
1128-943-M	103	1285	166	1560-1	211	1782-2	230	40-02	42
1129	124	1327-1	166	1561	211	1783	230	40-03	42
1129-8-1	125	1327-2	166	1562-1	212	1790-1	230	40-04	43
1129-8-15	124	1328-1	166	1563	211	1805	231	40-04-1	43
1129-8-2	125	1328-2	166	1563-1	211	1806	231	40-04-15	43
1129-8-3	125	1329-3	167	1564	212	1807	231	40-04-25	43
1129-8-4	125	1329-4	167	1565	212	1814-2	232	40-05	43
1129-8-5	125	1330	167	1565-41	212	1814-4	232	40-05-5	43
1129-8-6	125	1333	167	1566	213	1815	232	40-06	43
1129-8-8	125	1335	170	1567	213	1836	232	40-07	43
113	205	1337	171	1570	213	1837	233	40-12	44
1135	116	1340	172	1575	213	1840	233	40-12-M	48
1135-933-AF	103	1341	174	1576	214	1842	234	40-14	43
1135-933-M	103	1345	174	1577	214	1856	234	40-15	43
1170	244	1347	175	1577-1000	204	1857	234	40-16	43
1170-11	247	1348	176	1577-400	204	1905	234	40-17	45
1170-8	246	1360	99	1577-500	204	1920	235	40-18	45

Nummernverzeichnis Numerical Index

HEYCO-No.		HEYCO-No.		HEYCO-No.		HEYCO-No.		HEYCO-No.	
40-19	46	50-16	56	6501-5	88	900-8	99	K 350-7-M	12
40-20	46	50-19	58	6600	87	910-AF	103	K 350-8-AF	12
40-30	47	50-19-1	58	6600-19	87	910-M	103	K 350-8-M	12
40-31	47	50-19-3	58	6600-31	87	911-AF	103	K 400-10-AF	20
40-32	47	50-20	59	6601-10	88	911-M	103	K 400-10-M	20
40-35	47	503	96	6601-20	88	933-AF	103	K 400-12-AF	20
40-36	47	50-30	59	6601-3	88	933-M	103	K 400-12-M	20
40-50	48	50-31	59	6601-4	88	942-AF	103	K 400-15-M	20
40-6	44	50-32	60	6601-40	89	942-M	103	K 400-16-M	20
40-6-M	48	50-33	60	6601-41	89	943-AF	103	K 400-17-AF	20
40-75-M	49	50-34	60	6601-5	88	943-M	103	K 400-17-M	20
40-76-M	49	50-35	60	664	94	960-7	133	K 400-22-AF	20
40-85-M	49	50-36	60	665	94	961-7	134	K 400-22-M	20
40-88-M/AF	49	50-50-E/T	61	666	94	962-7	133	K 400-26-M	20
410	18	50-55-2-M	61	6700	90	963-9	134	K 400-6-AF	20
41-0010-M	50	50-58	61	695-1	95	966-7	134	K 400-8-AF	20
41-1010-AF	50	50-6	57	70-0010-M	68	967-4	135	K 400-8-M	20
41-3010-M	50	50-65-M	63	70-0-M	68	968-8	135	K 410-11-M	18
430	22	50-6-M	62	70-1010-AF	69	970-3	135	K 410-14-M	18
43-0010-M	50	50-75-M	63	70-3010-M	68	971-17	136	K 410-9-M	18
43-1010-AF	50	50-76-M	63	70-30-M	69	972-14	136	K 450-12-M	22
44-0010-M	51	50-77-AF	63	70-50-M	68	973-8	136	K 450-8-M	22
44-3010-M	51	50-80	64	70-80-M	69	976-42	137	K 475-12-AF	24
450	22	50-80-1	64	73-0310-M	69	977-6	137	K 475-12-M	24
4500	194	50-80-10	64	73-03-M	69	978-12-17	138	K 475-14-M	24
4500-100	194	50-80-2	64	73-3310-M	69	978-6-17	137	K 475-6-AF	24
45-0010-M	54	50-80-20	64	73-33-M	69	979-19-13	138	K 475-6-M	24
4501	194	50-80-3	64	75-0010-M	70	981-15	138	K 475-8-AF	24
4502	194	50-80-30	64	75-0110-M	71	982-18	139	K 475-8-M	24
4511	195	50-80-4	64	75-0310-M	72	983-23	139	K 530-8-M	98
4512	195	50-80-40	64	75-0-M	70	987-25	38	K 895-12-M	14
4515	196	50-85-M	64	751	94	987-40	48	K 895-6-M	14
4530	196	50-86-M	64	75-1010-AF	71	987-50	62	K 895-8-M	14
4535	196	50-87-AF	65	75-10-AF	71	990-4	139	K 896-12-M	98
4536	201	50-90	65	752	94	990-4-1	140	K 896-8-M	98
4537	197	50-95-M	65	75-3010-M	70	991-7	140	R 1335-6	170
4545	197	50-96-M	65	75-30-M	70	991-8	140	R 1337-6	171
4550	201	50-97-AF	65	75-3110-M	71	991-8-1	141	R 1340-10-AF	173
4560	198	530	97	75-3310-M	72	991-8-2	141	R 1340-10-M	173
4561	198	541	99	75-50-M	70	991-9	141	R 1340-12-AF	173
4562	198	545	99	756	94	992-4	142	R 1340-12-M	173
4563	198	57-0010	68	75-60-AF	71	993-7	142	R 1345-7	175
4564	199	600-10	96	757	94	994-2	142	R 1347-6	175
4565	199	610-1	97	75-80-M	70	995-8	143	R 1348-10	176
4566	199	610-10	97	76-0010-M	72	996-6	143	R 350-12-AF	13
4567	199	6101-30	35	77-0-M	73	997-6	143	R 350-12-M	13
4568	199	610-31	97	77-30-M	73	999-6	144	R 350-8-M	13
47-0010	51	6201-30	43	78-0010-M	73	B 350-8-M	11	R 400-12-AF	21
475	23	6300	81	78-0-M	73	B 400-12-M	20	R 400-12-M	21
493	25	6300-18	83	78-3010-M	73	B 400-8-M	20	R 400-13-AF	21
495	25	6300-19	82	78-30-M	73	B 530-8-M	97	R 400-13-M	21
49-5	157	6300-19-M	83	79-0010-M	74	E-970-4-ST	128	R 400-8-AF	21
497	25	6300-20	84	79-0310-M	74	E-970-5-ST	128	R 400-8-M	21
50-00-1	55	6300-31	83	79-3010-M	74	H 1340-5-AF	172	R 475-12-AF	24
50-00-10	55	6300-36	84	79-3310-M	74	H 1340-6-AF	172	R 475-12-M	24
50-00-15	55	6300-50	84	800	26	H 1340-6-M	172	R 475-8-M	24
50-00-7	55	6300-55	85	808	26	H 1340-7-M	172	R-896-9-M	98
50-02	55	6300-58	85	810	26	H 1348-8	176	SB 1664	219
50-03	55	6301-10	88	820	28	HP 1340-9	173	SB 1664-10	219
50-04	56	6301-2	88	840	29	HP 1343-9	174	SB 1664-10-2	219
50-04-1	56	6301-22	88	845	29	HP 1349-8	177	SB 1664-10-3	220
50-04-25	56	6301-4	88	894	13	HP 350-8-M	11	SB 1664-12	219
50-04-5	56	6301-40	89	895	14	HP 400-12-M	21	SB 1664-12-2	219
50-05	56	6301-41	89	896	98	HP 475-8-M	24	SB 1664-12-4	220
50-05-5	56	6500	86	900-10	99	K 400-14-M	20	SB 1664-2	219
50-06	56	6500-19	86	900-12	99	K 1340-8-AF	173	SB 1664-4	220
50-08	56	6500-31	86	900-14	99	K 1340-8-M	173		
501	96	6501-10	88	900-16	99	K 350-10-M	12		
50-10	56	6501-20	88	900-18	99	K 350-12-AF	12		
50-100	65	6501-22	88	900-20	99	K 350-12-M	12		
50-12	57	6501-3	88	900-3	99	K 350-13-M	12		
50-12-M	62	6501-4	88	900-4	99	K 350-14-M	12		
50-14-1	56	6501-40	89	900-5	99	K 350-6-AF	12		
50-15	56	6501-41	89	900-6	99	K 350-6-M	12		

Inhaltsverzeichnis

Artikel	
A	
Abisolierzange	153
Achsölwanne	235
Adapter	43
Auffangwanne	235/236
Aufreiber	179
Aufsteckrohre	29
Auswuchtgewichtzange	159
Automatischer Körner	214
B	
Bandmaß	233
Bandschlüssel	166
Blindnietensatz	164
Bremsfederzange	159
Bremsschüssigkeitstester	237
Bremsscheiben-Messschieber	232
C	
Cuttermesser	219-220
D	
Dichtungsschaber	220
Digitale Präzisionsschieblehre	231
Digitaler Reifenprüfer	234
Doppel-Gelenksteckschlüssel	25
Doppelmaulschlüssel	10/14
Doppelringschlüssel	22-25
Doppelsteckschlüssel	97
Drahtwirbelzange	162
Drehmomentadapter / Drehwinkelmeßgerät	95
Drehmomentschlüssel	94
Drehstange	99
Dreikant-Hohlchaber	218
Dreikant-Löffelschaber	218
Durchschläger	213
Durchsteckknarre	55/75
E	
Eck-Rohrzangen	167
Edelstahl-Drahtbürste	229
Einmaulschlüssel	13/15
Einringschlüssel	26
Einsatzspender	64-65
Einsteckringschlüssel	240
Elektriker Rucksack	158/187
Elektriker Schraubendreher	180/182
Ersatzbänder für Bandschlüssel	166
Ersatzköpfe für Hämmer	207-208
F	
Feilenbürste	229
Feilenhefte	222
Feilen-Satz	143
Flachrundzangen	151
Flachschaber	219
Flachzangen	150
Fühlerlehren	232
G	
Gelenkgriffe 1/2"	56
Gelenkgriffe 1/4"	35
Gelenkgriffe 3/8"	43
Gewindedorn	162
Gewindefeilen	221
Gewindenietensatz	162-163

Artikel	
H	
Glühkerzeneinsätze	45
Griff mit Gleitstück 1"	78
Griff mit Gleitstück 1/2"	55
Griff mit Gleitstück 1/4"	34
Griff mit Gleitstück 3/4"	75
Griff mit Gleitstück 3/8"	42
Gripzangen	165-166
H	
Hakenschlüssel	26
Hämmer	206-208
Handhebel Fettpresse	230
Hebelblechscheren	215-216
Hebeleisen	204-205
Holzgliedermaßstab	233
I	
IMPACT Werkzeuggarnitur	90
IMPACT-Schraubendreher Einsätze	83-87
IMPACT-Steckschlüssel-Einsätze	81-87
Isolierband	235
K	
Kabel-Klappmesser	221
Keil- und Zahnriemenschlüssel	238/240
Klauenschlüssel	15
Klemmleiste	38/48/62
Kniebrett	145
Kolbenring-Spannbänder	223
Kombinationszangen	149
Kombi-Spender	49/63-64
Kontaktfeilen	222
Körner	213
Kofflügelschoner	145
Kraftseitenschneider	152
Kraftvornschneider	153
Krallengreifer	191
Kreuzschlitz-Schraubendreher	177-178/195
Kreuzschlüssel	96-97
Kugelgelenke für IMPACT-Steckschlüssel-Einsätze	88
Kunststoffschaber	205
Kurbeln 1/2"	55
Kurbeln 3/8"	42
L	
Lambdasonde-Spezialwerkzeug	238
L-BOXX	66-67
LED-Taschenlampen	226-227
Lichtprüfer	188
Lochkreis-Messschieber	231
Lochschere	216
Löffelschaber	218
M	
Magnet-Bithalter	38/197
Magnethaftschale	236
Magnetheber	191
Meißel	209-211
Messer	221
Messwerkzeuge	144
Metallsägeblätter	214-215
Multifunktionstrichter	236
N	
Nageleisen	204
Nietkopfmacher/Nietzieher	214

Inhaltsverzeichnis

Artikel	
O	
Öldienstschlüssel	25
Ölfilterschlüssel	167
Ölspritzkanne	230
P	
Präzisions-Schieblehre	231
Präzisions-Stahlmaßstab	232
R	
Radmutternschlüssel	96
Reifen- und Montagehebel	204
Reifendruckprüfer	234
Reifen-Montierwerkzeug	205
Reißnadel	234
Ringmaulschlüssel	18-21
Rohrabschneider	217
Rohrsteckschlüssel	98
Rohrzangen	167
Rucksack	186
Rundzangen	150
S	
Saugheber	241
Schalterschrankschlüssel	190
Schlagdreher	81
Schlag-Maulschlüssel	26-27
Schlag-Ringschlüssel	28-29
Schlagschraubendreher-Satz	81
Schlüsselfeilen	223
Schraubenausdreher-Sätze	190
Schraubendreher	178-183/192-199
Schraubendreher- und Steckschlüssel-Einsätze	37-39/47-48/59-61
Schraubendreher-Sätze	140-141
Schutzbrille	228
Seitenschneider	152
Spannungsprüfer	188-189
Spannzange	159
Splinttreiber	212
Stahl-Drahtbürsten	229
Starter- und Blockschlüssel	22
Steckgriffe 1/4"	35
Steckschlüssel	99
Steckschlüssel-Einsätze 1"	79
Steckschlüssel-Einsätze 1/2"	57-60
Steckschlüssel-Einsätze 1/4"	36-37
Steckschlüssel-Einsätze 3/4"	76-77
Steckschlüssel-Einsätze 3/8"	44-47
Steckschlüssel-Garnituren	74-78/84/86
Steckschlüssel-Garnituren 1"	79
Steckschlüssel-Garnituren 1/2"	61-62/68-74
Steckschlüssel-Garnituren 1/4"	39-41
Steckschlüssel-Garnituren 3/4"	77
Steckschlüssel-Garnituren 3/8"	48/50-54
Stethoskop	234
T	
Teleskop-Spiegel	191
Türverkleidungs-Lösehebel	220
U	
Umschaltknarre 1"	78
Umschaltknarre 1/2"	55
Umschaltknarre 1/4"	34
Umschaltknarre 3/4"	75
Umschaltknarre 3/8"	42

Artikel	
Umsteck-Schraubendreher	189
V	
VDE Schraubendreher	184-185/200-201
VDE Spannungsprüfer	189
VDE Zangen	154-156
Verbindungsstück 1"	78
Verbindungsstück 1/2"	56
Verbindungsstück 1/4"	35
Verbindungsstück 3/4"	75
Verbindungsstück 3/8"	43
Verbindungsstücke IMPACT	88
Vergaser-Schraubendreher	181/197
Verkaufsstände	194
Verkaufswand	244-249
Verlängerungen	34/43/56/75/78
Verlängerungen IMPACT	88
W	
Wasserpumpenzangen	148-149
Werkstattfeilen	222
Werkstatt-Schraubendreher	179-181/196-197
Werkstattwagen	120-129
Werkstattwagen Module	131-144
Werkstattwagen Zubehör	124-125
Werkzeugkasten / Werkzeugschrank / Werkzeugtruhe	116
Werkzeugsortimente	103-115
Winkelgriffe 1/2"	56
Winkelschraubendreher	170-177/190
Z	
Zangen für Sicherungsringe	160-161
Zug-Ringschlüssel	29
Zündkerzenbürste	229
Zündkerzeneinsätze	45/58

Alphabetical Index

Article	
A	
Adapter	43
Adjustable center punch	214
Aluminium socket rail	38/48/62
B	
Backpack	186
Balancing weight plier	159
Beechwood folding rule	233
Blind rivet set	164
Bolt circle measuring gauge	231
Bradawls	179
Brake- and tyre profile-caliper	232
Brake fluid tester	237
Brake spring plier	159
C	
Cable-folding knife	221
Car light tester	188
Center punch	213
Chisels	209-211
Circlip pliers	160-161
Claw pick-up tool	191
Combination pliers	149
Combination wrenches	18-21
Compound action snips	215-216
Contact files	222
Converter 1"	78
Converter 1/2"	56
Converter 1/4"	35
Converter 3/4"	75
Converter 3/8"	43
Converters for IMPACT-Sockets	88
Cross slot screwdrivers	177-178/195
Crowfoot wrenches	15
Curved bearing scrapers	218
Cutter knives	219-220
D	
Diagonal cutting nippers	152
Diagonal cutting nippers	152
Digital torque angle applicator	95
Digital tyre gauge	234
Dispensers containing sockets and screwdriver sockets	49/63-64
Display stands	194
Door trim panel remover	220
Double ended open jaw wrenches	10/14
Double ended ring wrenches	22-25
Double ended socket wrenches	97
Double ended swivel wrenches	25
Double ended tubular socket wrenches	98
Drain pan	235/236
Drain pan for axle oil	235
Drain plug wrenches	25
E	
Elbow pipe wrenches	167
Electrician's backpack	158/187
Electricians' screwdrivers	180/182
End cutting nippers	153
Engineers' files	222
Engineers' screwdrivers	179-181/196-197
Extension	34/43/56/75/78
Extension bars for IMPACT-Sockets	88

Article	
F	
Feeler gauges	232
Fender cover	145
File card brush	229
File handles	222
Files set	143
Flat nose pliers	150
Four way rim wrench	96-97
G	
Gasket scraper	220
Glow plug sockets	45
Goose neck ripping bars	204
Grip pliers	165-166
H	
Hacksaw blades	214-215
Hammers	206-208
Hexagonal head wrenches	170-177/190
High pressure grease gun	230
Hole cutting snip	216
Hook wrenches	26
I	
Impact driver set	81
Impact drivers	81
IMPACT Tool set	90
IMPACT-Screwdriver-sockets	83-87
IMPACT-Sockets	81-87
Insulating tape	235
K	
Kneeling mat	145
Knives	221
L	
Lambda sensor-special tool	238
L-BOXX	66-67
LED Torchlights	226-227
M	
Magnetic bitholder	38/197
Magnetic pick-up tools	191
Magnetic shell	236
Measuring tape	233
Measuring tool set	144
Mechanics' stethoscope	234
Multifunction funnel	236
O	
Offset handle 1/2"	56
Oil can	230
Oil filter wrenches	167
P	
Parallel pin punch	212
Perforated tool bar system	244-249
Pipe wrenches	167
Piston ring compressors	223
Plastic scraper	205
Precision steel rule	232
Precision vernier caliper	231
Precision vernier caliper	231
Protective glasses	228

Alphabetical Index

Article	
R	
Ratchet, push-thru type	55/75
Reversible ratchet 1"	78
Reversible ratchet 1/2"	55
Reversible ratchet 1/4"	34
Reversible ratchet 3/4"	75
Reversible ratchet 3/8"	42
Reversible screwdriver	189
Rivet nut set	162-163
Rivet-header / Rivet-set	214
Round nose pliers	150
S	
Screw extractor sets	190
Screwdriver set	140-141
Screwdriver sockets	37-39/47-48/59-61
Screwdrivers	178-183/192-199
Scriber	234
Single ended open jaw wrenches	13/15
Single ended ring wrenches	26
Single ended ring wrenches	29
Sliding T-handles 1"	78
Sliding T-handles 1/2"	55
Sliding T-handles 1/4"	34
Sliding T-handles 3/4"	75
Sliding T-handles 3/8"	42
Slogging open jaw wrenches	26-27
Slogging ring wrenches	28-29
Snipe nose pliers	151
Socket dispensers	64-65
Socket sets	74-78/84/86
Socket sets 1"	79
Socket sets 1/2"	61-62/68-74
Socket sets 1/4"	39-41
Socket sets 3/4"	77
Socket sets 3/8"	48/50-54
Sockets	99
Sockets 1"	79
Sockets 1/2"	57-60
Sockets 1/4"	36-37
Sockets 3/4"	76-77
Sockets 3/8"	44-47
Spare hammer heads	207-208
Spare straps for strap wrenches	166
Spark plug brush	229
Spark plug sockets	45/58
Special pry bars	204-205
Speed brace 1/2"	55
Speed brace 3/8"	42
Spinner handle 1/4"	35
Square scrapers	219
Stainless steel wire brush	229
Starter and manifold wrenches	22
Strap wrenches	166
Stubby screwdrivers	181/197
Suction lifters	241
Swivel handels 1/2"	56
Swivel handels 1/4"	35
Swivel handels 3/8"	43

Article	
T	
Taper pin punch	213
Telescopic inspection mirrors	191
Thread restorers	221
Threaded mandrel	162
Tommy bar	99
Tongs for axle collars and hose clamps	159
Tool assortments	103-115
Tool boxes	116
Torque wrenches	94
Triangular bearing scrapers	218
Triangular hollow scrapers	218
Tube-cutter	217
Tubular handles	29
Tyre change presser	205
Tyre levers	204
Tyre pressure gauges	234
U	
Universal control cabinet key	190
Universal joints for IMPACT-Sockets	88
V	
V-Belt and cam belt-wrench	238/240
VDE Cross slot screwdrivers	184-185/200-201
VDE pliers	154-156
VDE Voltage tester	189
Voltage tester	188-189
W	
Warding files	223
Water pump pliers	148-149
Wheel nut wrenches	96
Wire brushes	229
Wire stripping plier	153
Wire swivelling pliers	162
Workshop trolley accessories	124-125
Workshop trolley modules	131-144
Workshop trolleys	120-129
Wrench insert tool	240

Verkaufs-, Lieferungs- und Zahlungsbedingungen

1. Anerkennung der Verkaufs-, Lieferungs- und Zahlungsbedingungen

Unsere Verkäufe basieren auf den nachstehenden Bedingungen, wobei jeweils nur die neuesten Verkaufsunterlagen Gültigkeit besitzen. Abweichungen oder mündlich getroffene Nebenabsprachen bedürfen unserer schriftlichen Bestätigung.

Bedingungen der Besteller können wir nicht anerkennen, auch dann nicht, wenn von uns nicht ausdrücklich widersprochen wird. Der Besteller erkennt durch die Erteilung seines Auftrages unsere Bedingungen an.

Vertragsgültigkeit wird erst durch unsere schriftliche Auftragsbestätigung erreicht.

2. Angebote

Unsere Angebote sind freibleibend, Katalog und Preisliste sind Bestandteil unserer Angebote.

Maß- und Gewichtsangaben sowie Abbildungen, Leistungsbeschreibungen, technische Zeichnungen und Daten sind unverbindlich, sofern sie nicht ausdrücklich als verbindlich bestätigt werden; sie können jederzeit und ohne besondere Anzeige geändert werden.

3. Schutzrechte

Werkseigene Zeichnungen, Abbildungen, Photos und sonstige Unterlagen bleiben auch nach Weitergabe an den Besteller oder an Dritte unser Eigentum und unterliegen dem Urheberrecht. Ohne unsere Erlaubnis dürfen diese weder vervielfältigt noch anderen zugänglich gemacht werden; sie sind an einem sicheren Ort aufzubewahren und auf Verlangen an uns zurückzugeben.

Werden bei der Anfertigung von Waren nach Zeichnungen, Mustern bzw. sonstigen Angaben des Bestellers Schutzrechte Dritter verletzt, so stellt dieser uns von sämtlichen Ansprüchen frei.

4. Sonderanfertigungen

Bei Sonderanfertigungen behalten wir uns das Recht einer Mehr- bzw. Minderlieferung bis zu 10% vor. Hierzu zählen ebenfalls Serienteile, die auf ausdrücklichen Wunsch des Bestellers besonders zu zeichnen sind. Der Besteller kann nicht vom Auftrag zurücktreten; besonders hergestellte oder gezeichnete Ware wird von uns nicht zurückgenommen.

Im Falle von Zahlungsunfähigkeit bzw. Konkurs des Bestellers behalten wir uns das Recht vor, die Ware direkt zu verkaufen.

Bei Herstellung nach Unterlagen des Bestellers haftet dieser für die Richtigkeit seiner Zeichnungen, Muster, Lehren usw.

Muster werden grundsätzlich nur gegen Berechnung geliefert.

5. Preise

Unsere Preise sind freibleibend und als unverbindliche Preisempfehlung anzusehen. Sie verstehen sich ausschließlich Mehrwertsteuer, wobei der am Tage der Lieferung gültige Mehrwertsteuersatz Anwendung findet.

Eine Berichtigung unserer Preise behalten wir uns vor, sofern bis zum Tage der Lieferung Änderungen in den Grundkosten, wie Rohmaterial, Energie, Löhne usw. eintreten.

Lieferungen erfolgen grundsätzlich in den im Katalog genannten Verpackungseinheiten. Kleinere oder durch die Verpackungseinheiten nicht teilbare Mengen werden lose in Papier verpackt und mit einem Aufschlag von 25% belastet, sofern in unseren Verkaufsunterlagen kein anderweitiger Vermerk gemacht wird.

6. Zahlungsbedingungen

Unsere Rechnungen sind zahlbar

Inland:

10 Tage nach Rechnungsdatum, abzüglich 2% Skonto oder 30 Tage nach Rechnungsdatum netto, falls keine anderen Vereinbarungen getroffen wurden.

Ausland:

Nach besonderen Vereinbarungen; maßgebend ist der Zahlungsvermerk auf dem jeweiligen Angebot, der Proforma-Rechnung bzw. der Rechnung.

Beträge unter EUR 25,- netto sind grundsätzlich nicht skontoberechtigt.

Wechsel werden nur nach vorheriger Vereinbarung hereingenommen. Die Kosten der Diskontierung und Einziehung trägt grundsätzlich der Besteller.

Bei Zahlungsverzug oder Stundung belasten wir Zinsen in Höhe von 2% über dem zu diesem Zeitpunkt gültigen Diskontsatz der Deutschen Bundesbank.

Die Wertstellung eingegangener Schecks und Wechsel erfolgt zu dem Tag, an dem wir über den Gegenwert verfügen können.

Sollten uns nach Vertragsabschluss Umstände bekannt werden, welche die Kreditwürdigkeit des Kunden beeinträchtigen, sind wir berechtigt, Vorauszahlung oder andere Sicherheitsleistungen zu verlangen.

Eine Zurückhaltung der Zahlung wegen Minderungs-, Wandlungs- oder eventueller anderer Gegenansprüche sowie die Aufrechnung mit solchen, ist nicht zulässig.

7. Lieferung und Versand

Wenn nicht anders vereinbart, liefern wir grundsätzlich ab Werk, ausschließlich Verpackung, wobei Lieferung und Versand der Ware auf Gefahr des Bestellers erfolgen. Versicherungen gegen Diebstahl, Transportschäden usw. erfolgen nur auf Wunsch und Kosten des Bestellers. Falls keine besondere Vorschrift gegeben wird, wählen wir den nach unserem Ermessen günstigsten Versandweg.

Waren, die zu einem vereinbarten Termin versandbereit gemeldet werden, müssen umgehend abgerufen werden, da wir andernfalls berechtigt sind, diese auf Kosten und Gefahr des Bestellers zu lagern und als geliefert zu berechnen.

Für Verladungen setzen wir Netto-Mindestauftragswerte wie folgt voraus:

Inland – EUR 100,- Ausland – EUR 500,-

sofern in unseren Verkaufsunterlagen kein anderweitiger Vermerk gemacht wird.

Wir behalten uns vor, Aufträge unter dieser Grenze entweder bis zum Erreichen des Mindestauftragswertes zurückzustellen oder mit einer Bearbeitungsgebühr von EUR 10,- zu belasten.

8. Eigentumsvorbehalt

Die gelieferte Ware bleibt bis zur endgültigen Bezahlung, ohne Rücksicht auf den Rechtsgrund, unser Eigentum. Für den Fall der Bezahlung auf Scheck-Wechselbasis bleibt der Eigentumsvorbehalt bis zur Einlösung des Wechsels durch den Besteller bestehen.

Der Besteller ist, so lange er sich nicht in Verzug oder in Zahlungsschwierigkeiten befindet, zur Veräußerung der Ware im ordnungsgemäßen Geschäftsverkehr berechtigt. Veräußert der Besteller die in unserem Vorbehaltsrecht stehende Ware, werden die durch die Veräußerung entstehenden Forderungen schon jetzt an uns abgetreten, ohne daß es im Falle der Veräußerung einer ausdrücklichen Bestätigung bedarf. Er ist nicht berechtigt, die Vorbehaltswaren zu verpfänden oder zur Sicherheit an Dritte zu übereignen.

Bis zur endgültigen und vollständigen Bezahlung der Ware steht uns das Recht zu, auch ohne Ausübung des Rücktritts und ohne Nachfristsetzung auf Kosten des Bestellers, die einstweilige Herausgabe der Vorbehaltsware zu verlangen, die Räumlichkeiten des Bestellers zu betreten und die Ware nötigenfalls wieder an uns zu nehmen.

Wird eine Be- oder Verarbeitung bzw. untrennbare Vermischung der Vorbehaltsware mit anderen, nicht dem Lieferer gehörenden Gegenständen, vorgenommen, so erwerben wir das Miteigentum an der

neuen Sache im Verhältnis des Rechnungswertes der Vorbehaltswaren zu den anderen verarbeiteten oder vermischten Gegenständen zum Zeitpunkt der Verarbeitung oder Vermischung. Wird die gelieferte Ware vom Besteller oder dessen Beauftragten verändert oder als Teil größerer Einheiten verwendet, so geht unser Eigentum anteilmäßig automatisch auf die veränderte Ware oder die entstandenen größeren Einheiten über. Der Besteller verwahrt das Eigentum oder Miteigentum für den Lieferer und ist verpflichtet, dieses gegen Feuer, Diebstahl und Wasser zu versichern. Etwaige Entschädigungsansprüche, die aus Schäden vorgenannter Art gegen Versicherungsgesellschaften oder sonstige Ersatzverpflichtete entstehen, werden in Höhe unserer Forderungen an uns abgetreten.

Pfändungen oder andere Beeinträchtigungen unseres Eigentums, sind uns unverzüglich mitzuteilen.

Ohne die bisher dargelegten Bedingungen einzuschränken, geht das Risiko für die gelieferte Ware vom Tage der Lieferung auf den Besteller über.

9. Lieferzeit, Liefermöglichkeit

Lieferfristangaben sind annähernd und ohne Verbindlichkeit für uns. Verzugsgebühren und Schadensersatzansprüche bei Lieferverzögerungen können gegen uns in keinem Fall geltend gemacht werden. Die Lieferzeit beginnt nach Klärung sämtlicher kaufmännischer und technischer Einzelheiten. Wir sind berechtigt, Teillieferungen durchzuführen.

10. Höhere Gewalt

Streik und Aussperrung, Katastrophen, Betriebsstörungen, Materialmängel, Verkehrsmängel oder andere Ereignisse höherer Gewalt, ganz gleich, ob sie bei uns oder bei unseren Vorlieferanten eintreten, entbinden uns von allen Verpflichtungen.

11. Mangelrügen

Beanstandungen werden nur entgegengenommen, wenn sie schriftlich und umgehend, d. h. sofort nach Erhalt der Sendung, angezeigt werden. Ein Recht auf Wandlung oder Minderung steht dem Besteller nicht zu. Über den Warenwert hinausgehende Ansprüche können nicht gestellt werden. Transportschäden sind stets beim Frachtführer zu reklamieren.

12. Garantie, Gewährleistung

Alle HEYCO-Werkzeuge werden in unseren Werken sorgfältig überprüft und unterliegen voll der Garantie.

Wir ersetzen jedes Werkzeug kostenlos, das Material- oder Fertigungsfehler aufweist. Eine weitere Haftung ist ausgeschlossen. Kostenloser Ersatz erfolgt nicht, wenn die Untersuchung in unserem Werk ergibt, daß das Werkzeug unsachgemäß behandelt worden ist oder ein natürlicher Verschleiß vorliegt.

13. Haftung

Schadenersatzansprüche aus Fehlen zugesicherter Eigenschaften, Verzug, Unmöglichkeit der Leistung, schuldhafter Verletzung vertraglicher Nebenpflichten sowie aus Verschulden bei Vertragsabschluß und aus unerlaubter Handlung, werden ausgeschlossen, es sei denn, sie beruhen auf Vorsatz oder grober Fahrlässigkeit unserer gesetzlichen oder sonstigen uns zuzurechnenden Vertreter.

Die Haftung wird auch für grob fahrlässige Verletzungen auf den Ersatz des zum Zeitpunkt des Vertragsabschlusses voraussehbaren Schadens begrenzt.

14. Erfüllungsort und Gerichtsstand

Erfüllungsort der Lieferung und Zahlung ist Remscheid. Gerichtsstand ist Remscheid. Es gilt das Recht der Bundesrepublik Deutschland.

15. Export und Re-Export

HEYCO-Ware darf nur mit unserer schriftlichen Genehmigung exportiert oder re-exportiert werden.

Terms of Sale, Delivery and Payment

1. Acceptance of terms of sale, delivery and payment

Our sales are based on the following terms and conditions whereby only the latest issue of our sales literature is valid. Any variations to these and verbal arrangements require our confirmation in writing. Conditions of the buyer shall not be binding to us, also if not expressly objected by us. The placing of an order/contract with us implies acceptance of our conditions. Validity of contract is only reached with our written order confirmation.

2. Quotations

Our offers are without obligation. Catalogue and price list form part of our offers. Weights and dimensions, illustrations, performance details, technical drawings and data are subject to change without prior notice, unless contracted and confirmed otherwise.

3. Copyright

All drawings, illustrations, photographs and other documents supplied by us to customers or third parties remain our property and are subject to copyright. They are not to be reproduced or made available to others without our written consent; they are to be stored in a safe place and must be returned to us on demand. Should production of merchandise to drawings, samples or other customer's specification involve an infringement of third party copyrights the customer indemnifies us from and against all claims.

4. Special manufacture

We reserve the right to modify the quantities ordered for special production by plus or minus 10%, also normal production items, which are marked or finished to buyer's special requirements. Such orders cannot be cancelled once accepted by us. We are unable to accept the return of such items for credit or allowance. If the customer becomes insolvent or bankrupt we reserve the right to sell this merchandise directly. For production to customers documents the customer shall be solely responsible for the accuracy of drawings, samples, gauges etc. On principle samples are only supplied against invoice.

5. Prices

We reserve the right to adjust prices in case there should be changes in basic production costs, such as raw material, power, wages etc. up to the date of delivery. Parts ordered will only be shipped in packing units identified in our sales literature. Smaller quantities or quantities, which are not divisible by packing units will be packed in paper only and levied with an increase of 25% provided no other information has been given in our sales literature.

6. Terms of payment

Our invoices are payable
Home market:
10 days after date of invoice less 2% cash discount or 30 days after date of invoice net, provided no other arrangements have been agreed.
Export markets:
According to special arrangements, which are stated on our quotations, pro-forma-invoices, order confirmations and/or invoices.
On principle invoice values below Eur 25.- net do not qualify for cash discount. Drafts will only be accepted after prior arrangements and all charges are to buyer's account.
In the event of delayed payments or respites we shall charge interests at a rate of 2% above the bank rate of the Deutsche Bundesbank being in force at the relevant time.
The credit values of cheques and drafts received are entered for that day, when countervalue is at our disposal.

In case we should learn about circumstances restricting the creditworthiness of the customer after a contract has been concluded, we are permitted to ask for payment in advance or other satisfactory securities. Retention of payment due to claims of diminution, transformation or other eventual counter-claims as well as settling of accounts incorporating the above is not permissible.

7. Dispatch and delivery

Unless arranged and confirmed to the contrary delivery is effected ex works, packing excluded. Goods are delivered at buyer's risk. Insurance against theft, damages in transit etc. can be arranged on specific request and to customer's account. We reserve the right to choose the most economic method of transport unless particular instructions are given. Goods, which have been packed to be ready for dispatch for an agreed date must be called off immediately, as otherwise we are entitled to store same at buyer's risk and cost and to invoice shipment as delivered.

For shipments our minimum net order values are

Home market: Eur 100.- Export markets: Eur 500.-

unless no other terms are quoted in our sales literature. For orders with smaller values we reserve the right to postpone shipment until minimum order value is reached or to charge a handling fee amounting to Eur 10.-

8. Title to the goods

Goods delivered remain our property until payment is received in full. It is expressly reserved that any law contradicting this clause shall not impair our rights concerning our goods. The buyer may dispose of the goods in the usual businesslike manner provided he is not insolvent or in default. Should the customer sell goods, which are still our property respective credit is due to our account automatically without express confirmation. The buyer is not entitled to distrain or, as security to third parties, assign goods which are still our property. Until paid for in full we are entitled to demand the release of goods and to enter buyer's premises with the object of re-taking possession of the goods. We are not obliged to execute withdrawal and to award postponement at customer's costs. In case processing, further treatment or inseparable blending of provisogoods is effected with other merchandise or parts not belonging to us, we automatically gain partial ownership on the processed goods to such value as it is in relation to the processed or blended merchandise at the moment of processing or blending. Should supplied goods through buyer or on behalf of buyer be subjected to alterations or be used as part of larger units, then automatically partial ownership is transferred to the changed merchandise or the produced larger units. The buyer storing seller's property or partial property is obliged to secure same against fire, theft and water. Eventual claims for damages against insurance companies resulting from damages mentioned before are to be assigned to us representing the amount of our claim. Distraints and/or any other limitation, which might be imposed on our property despite the reservations outlined in the proceeding sentences must be reported immediately. Notwithstanding the conditions outlined above, goods are at the entire risk of the buyer from the date of delivery.

9. Time of delivery and delays

All information given in respect of delivery period is approximate and without obligation. Liability in case of delay in delivery, interest for delay and/or damages cannot be accepted. The time of delivery begins only after clarification of all clerical and technical details. We are permitted to effect part shipments.

10. Force majeure

Force majeure, such as strike and lock-out, catastrophes of any kind, break-down in supply of any kind, delivery of faulty material or other restrictions through force majeure shall release us from our liabilities, no matter if occurred with us or our sub-suppliers.

11. Claims

Claims must be made immediately on receipt of the goods and in writing, as otherwise such claims will not be accepted by us. Amendments to or deductions from invoices will not be accepted. The customer is not entitled to make claims above the nominal value of the goods involved. Damages in transit are to be claimed with the carrier.

12. Guarantee, warranty

All HEYCO tools are carefully tested before leaving our works and are fully guaranteed. We shall replace free of charge any tool indicating faults of material and workmanship. Any further liability is excluded. Tools returned as faulty, which on inspection/ test prove to have failed due to abuse, incorrect use or fair wear and tear are excluded from this guarantee and replacement will be charged.

13. Liability

Claims for compensation due to missing of promised features, delays, impossibility of performance, guilty violation of contractual secondary obligations, faults with conclusion of contract as well as unauthorized action are excluded save where our legal representatives are shown to have acted on purpose or negligently. Liability even for careless violation is limited to compensation, which is foreseeable at the moment of conclusion of contract.

14. Settling place and place of competency

Remscheid is the settling place for delivery, payment and competency of justice in case of dispute. Only the law of the Federal Republic of Germany shall govern.

15. Export and re-export

Only with our written approval HEYCO goods may be exported or re-exported.

Conditions de vente, de livraison et de paiement

1. Commandes

L'acceptation de nos offres entraîne l'acceptation, sans exception ni réserve, des présentes conditions qui régiront toutes nos ventes et prévaudront nonobstant toutes stipulations contraires pouvant figurer sur les bons de commandes de l'acheteur, ses conditions générales d'achat ou tout autre document émanant de lui. Tous les ordres, même ceux pris par nos agents commerciaux ou nos importateurs étrangers, ne nous engageant qu'après acceptation écrite de notre part. Les caractéristiques et cotes portées sur nos catalogues figurent à titre indicatif.

Elles ne nous engagent en aucun cas. Toutefois, l'acheteur conserve la possibilité de spécifier les caractéristiques auxquelles il subordonne sa commande. Les études et documents de toute nature que nous remettons à nos clients restent notre propriété et doivent nous être rendus sur demande quand bien même il aurait été facturé une participation aux frais d'étude. Ils ne peuvent en aucun cas être communiqués ou exécutés sans notre accord formel écrit.

2. Offres

Nos offres sont stipulées sans engagement de notre part.

Notre catalogue et notre tarif font partie intégrante de ces offres. Les indications de dimensions et de poids, ainsi que les illustrations, détails de performance, dessins techniques et caractéristiques ne sont pas contractuels, sauf en cas de confirmation formelle et peuvent être modifiés à tout moment sans préavis.

3. Droit de propriété

Les dessins techniques, illustrations, représentations photographiques et autres documents remis à nos clients ou à des tiers, restent notre propriété et sont soumis au droit de propriété. Ces documents ne doivent pas être reproduits ou mis à la disposition d'autres personnes sans notre autorisation expresse; ils sont à conserver en sécurité et à nous retourner sur demande de notre part.

Si la fabrication des marchandises, d'après les dessins techniques, échantillons ou spécifications de l'acheteur, implique une cession des droits de propriété à des tiers, l'acheteur nous libère de toutes revendications.

4. Fabrications spéciales

Pour les articles faisant l'objet d'une fabrication spéciale, nous nous réservons le droit d'augmenter ou de diminuer l'importance de la livraison à concurrence de 10%. Cela s'applique également aux articles fabriqués en série mais avec marquage spécial, conforme à la demande de l'acheteur. Le client n'a pas le droit de résilier le contrat; la marchandise faisant l'objet d'une fabrication spéciale ou d'un marquage spécial ne sera pas reprise.

En cas d'insolvabilité de l'acheteur ou de faillite, nous nous réservons le droit de revendre directement la marchandise. Dans le cas d'une fabrication d'après la documentation de l'acheteur, celui-ci est responsable de l'exactitude de ses dessins, échantillons, jauges de contrôle, etc.

Les échantillons ne sont livrés que contre paiement.

5. Prix

Nos prix sont indiqués hors taxe et sont sans engagement de notre part. Nos prix sont réputés fermes pour une durée de validité précisée sur nos devis ou nos tarifs.

Cependant, nous nous réservons le droit de modifier nos prix en cas de changement dans la structure des coûts de production, des coûts des matières premières, de l'énergie, des salaires, etc. et ceci jusqu'à la date de livraison.

En principe, nos livraisons sont effectuées selon les unités d'emballage indiquées dans notre catalogue. Les commandes de quantités inférieures ne bénéficieront pas de l'emballage prévu d'origine (telle que boîtes carton, pochettes, étuis ...) et seront majorées de 25%, sauf indication contraire dans notre documentation.

6. Conditions de paiement

Toutes nos ventes sont considérées comme traitées et payables à REMSCHEID, l'acceptation de traites ne

dérogé pas à cette clause, quels que soient le mode de paiement et le lieu de livraison. Nos factures sont payables:

Marché intérieur:

10 jours date de facture moins 2% d'escompte ou 30 jours nets date de facture, à moins que des conditions particulières ne soient accordées.

Marché étranger:

suivant conditions particulières qui sont indiquées dans nos offres, factures proforma, confirmations de commandes et factures.

Si le montant de la facture est inférieur à 25 EUR, aucun escompte ne sera accordé. En cas de paiement par traite, les frais d'escompte ou d'encaissement seront à la charge de l'acheteur.

Le non-paiement d'une facture à son échéance entraîne le paiement de pénalités au taux mensuel excédant le taux d'escompte actuel de la Deutsche Bundesbank de 2%, calculé au prorata du nombre de jours de retard. Cette pénalité étant convenue formelle entre les parties ne nécessitera aucune mise en demeure préalable. Le nonpaiement d'une échéance quelconque entraînera d'autre part automatiquement l'exigibilité de la totalité du solde restant dû et la suspension des livraisons. Nous nous réservons le droit d'exiger le paiement comptant avant la livraison si la situation financière de l'acheteur le justifie.

En cas de litige, tant avec nos fournisseurs qu'avec nos clients, attribution de compétence est faite aux Tribunaux de REMSCHEID, suivant la législation s'appliquant en Allemagne.

7. Livraison et expéditions

Nos prix s'entendent départ usine, emballage non compris, sauf stipulation écrite spéciale. La facturation du coût de transport est à la charge de l'acheteur et dépend de la nature du matériel et du lieu de livraison. Les marchandises voyagent aux risques et périls du destinataire. En cas d'avaries survenues au cours du transport, il incombe au destinataire d'exercer tous recours contre le transporteur.

En cas de retraiton, si l'acheteur n'enlève pas le matériel à la date de livraison, nous pourrions, aux frais, risques et périls exclusifs de l'acheteur, pourvoir au déplacement, au stockage et à l'assurance du matériel dans nos locaux ou en tout autre lieu, l'acheteur restant intégralement tenu de l'ensemble de ses obligations.

Sauf stipulation contraire, les expéditions sont effectuées si la valeur nette de la commande est au moins de:

– marché intérieur: 100 EUR

– marché étranger: 500 EUR

Nous nous réservons le droit d'ajourner la livraison des commandes jusqu'à ce que cette valeur minimum soit atteinte ou de facturer des frais de rémunération d'un montant de 10 EUR.

8. Clause de réserve de propriété

Conformément à la loi no 80-335 du 12 mai 1980 et à la loi du 25 janvier 1985, nous nous réservons l'entière propriété du matériel livré jusqu'au complet paiement du prix facturé. Nous pourrions en exiger la restitution immédiate en cas de défaut de paiement.

L'acheteur s'oblige personnellement à l'égard du vendeur à ne pas disposer par quelque moyen que ce soit, ni en pleine propriété, ni par constitution de gages, des marchandises achetées avant le paiement intégral du prix. En cas d'opposition de l'acheteur à la restitution des marchandises impayées, une simple ordonnance de référé vaudra résolution de la vente et autorisation de reprendre les marchandises. Les acomptes versés nous resteront à titre de dommages-intérêts.

Malgré l'application de la présente réserve de propriété, l'acheteur supportera la charge des risques en cas de détérioration des marchandises. Il supportera également les charges de l'assurance.

9. Délais

Les délais de livraison sont donnés à titre indicatif. Les retards ne peuvent donner lieu à des dommages-intérêts.

Nous sommes autorisés à effectuer des livraisons partielles.

Nos délais de livraison commencent après la mise au point de tous les détails d'ordre commercial et/ou technique.

10. Force majeure

Nos obligations contractuelles sont suspendues de plein droit en cas de survenance de toute circonstance indépendante de notre volonté et celle de nos fournisseurs, intervenant après la conclusion du contrat et en empêchant l'exécution dans des conditions normales (grèves, défaut ou difficultés d'approvisionnement en matières premières, retard dans les transports de marchandises, réduction autoritaire des importations ...).

11. Réclamations pour défauts

Pour être valable, les réclamations doivent être faites par écrit immédiatement après réception de la marchandise.

L'acheteur n'a pas le droit à une transformation ou à une réduction et ne peut faire valoir aucun droit allant au-delà de la valeur de la marchandise. Les avaries de transport doivent toujours être exprimées et réclamées aux transporteurs.

Les réclamations concernant la qualité de la marchandise, à l'exclusion de tout litige de transport, devront être faites immédiatement lors de la livraison ou de la retraiton en notre usine lorsqu'il s'agit d'un défaut apparent et dans les 48 heures concernant ladite livraison ou la retraiton, lorsqu'il s'agit d'un défaut non apparent au premier abord.

12. Garantie

Tous les outils HEYCO font l'objet d'un contrôle minutieux en notre usine et bénéficient d'une pleine garantie. Nous remplaçons gratuitement chaque outil qui présenterait un défaut de matière ou un vice de fabrication. La garantie comprend l'échange de la pièce mais ne s'applique pas aux remplacements ou réparations qui résulteraient de l'usure normale du matériel, de détériorations ou d'accidents provenant de négligences, de défaut de surveillance ou d'entretien, d'installation défectueuse ou de tout autre motif échappant à notre contrôle. La garantie HEYCO ne peut être appliquée si le matériel fourni à été modifié ou réparé sans notre accord. Nous n'acceptons aucun retour de matériel sans accord préalable de notre part. En cas de retour à notre entrepôt, les frais de transport et d'emballage sont à notre charge. La non-conformité des marchandises devra être constatée à la livraison ou à la réception. Nous nous engageons à procéder à l'échange, au remplacement ou à la modification de la marchandise non conforme dans les plus brefs délais; l'acheteur renonce à tous recours contre le vendeur pour les dommages qu'il supporte du fait de la non-conformité. En tout état de cause, notre garantie contractuelle ne se substitue pas à la garantie légale qui nous oblige à garantir l'acheteur contre tous les défauts et vices cachés de la chose vendue. Cependant, la garantie contractuelle n'implique en aucun la possibilité d'une demande de dommages-intérêts ou d'indemnités. Nous ne sommes pas responsables en cas de destination particulière du matériel ou sujétion non déclarée par l'acheteur dans le bon de commande.

13. Responsabilité

Les demandes d'indemnisation par suite d'un manque de précision des caractéristiques, retard, impossibilité de performance, lésion fautive par obligations contractuelles marginales, ainsi que toutes fautes consécutives à la conclusion du contrat ou les actions d'utilisation non autorisées, sont exclues, à moins qu'il ne s'agisse d'une grave négligence intentionnelle de la part de nos mandataires légaux.

14. Exportation et réexportations

La marchandise HEYCO ne peut être exportée ou réexportée que sur notre autorisation expresse.

15. Litiges

En cas de différends portant sur l'interprétation ou l'exécution du contrat de vente, la législation allemande s'applique et les Tribunaux de REMSCHEID sont seuls compétents, même en cas d'appel en garantie, de pluralité de défendeurs et nonobstant toute clause contraire.

Condiciones de venta, entrega y pago

1º – Aceptación de las condiciones de venta, entrega y pago

Nuestras ventas se basan en las condiciones que se detallan a continuación, teniendo validez solamente la documentación de venta más reciente. Cualquier modificación o acuerdos verbales, requieren nuestra confirmación por escrito.

No podemos aceptar condiciones puestas por nuestros clientes, ni siquiera en el caso de que nosotros no manifestemos de manera expresa nuestro rechazo de las mismas. El cliente, por el mero hecho de pasar el pedido, acepta nuestras condiciones. El contrato de venta adquiere su validez mediante nuestra confirmación de pedido por escrito.

2º – Ofertas

Nuestras ofertas se entienden salvo modificación posterior. Catálogo y tarifa de precio forman parte de nuestra oferta. Indicaciones de medidas y peso, reproducciones, descripciones de prestaciones, planos técnicos y demás datos se entienden como no vinculantes, salvo indicación expresa de nuestra parte que confirme lo contrario. Dichas especificaciones podrán ser modificadas en cualquier momento y sin previo aviso.

3º – Propiedad industrial

Planos, reproducciones, fotos y demás documentos seguirán siendo propiedad nuestra, incluso una vez remitidos a clientes o terceros y están sujetos a los derechos de autor. Dichos documentos no podrán ser copiados o facilitados a terceros sin nuestra autorización expresa. El receptor debe comprometerse a guardarlos en sitio seguro y devolvérselos a requerimiento nuestro.

Caso de que al fabricar artículos en base a planos, muestras u otras especificaciones facilitados por el cliente se lesionen derechos de propiedad industrial de terceros, la responsabilidad será exclusivamente del cliente.

4º – Fabricaciones especiales

En el caso de fabricaciones especiales, nos reservamos el derecho de desviarnos de la cantidad pedida en un más/menos 10%. Esto se aplica también a piezas de fabricación normal que lleven un marcado especial por encargo expreso del cliente.

En este caso no se admitirá ninguna cancelación del pedido. Tampoco se aceptará devolución alguna de mercancía especial o con marca del cliente.

Caso de producirse la suspensión de pagos o la quiebra del cliente, nos reservamos el derecho de vender tal mercancía directamente.

En el caso de una fabricación basada en documentos facilitados por el cliente, será éste el que se responsabilice de la exactitud de planos, muestras, calibres, etc.

Muestras se facilitarán siempre con cargo.

5º – Precios

Nos reservamos el derecho de modificar nuestros precios si hasta la fecha de expedición de la mercancía se hubieran producido cambios de nuestros costos, como p.e. de la materia prima, energía, salarios, etc.

El suministro se efectuará siempre en base a las unidades de envase indicadas en catálogo. Cantidades inferiores o no coincidentes con las unidades de envase se enviarán sueltas, simplemente envueltas en papel, y se cargarán con un aumento de precio del 25 %, salvo indicación contraria constatada en nuestra oferta.

6º – Condiciones de pago

Nuestras facturas son pagaderas:

En el mercado interior:

10 días fecha factura con el 2% de descuento por pronto pago o 30 días fecha factura, neto, salvo convenio específico de condiciones diferentes.

En exportación:

Según convenio específico. Será vinculante la condición de pago indicada en nuestra oferta, factura proforma o factura.

En el caso de facturas por un valor inferior a EUR 25,-, no se admite descuento por pronto pago.

El pago contra letra de cambio se admitirá sólo previo acuerdo. Los gastos de descuento y presentación al cobro serán por cuenta del cliente.

En el caso de producirse retrasos en el pago o un aplazamiento del mismo, cargaremos un tipo de interés equivalente al tipo de descuento fijado por el Deutsche Bundesbank (Banco Federal alemán) + un 2% adicional.

Talones y letras se valorarán a la fecha en que nosotros podamos disponer de su contravalor.

Si nos llegase información que pusiera en duda el crédito de un determinado cliente, nos reservamos el derecho de exigir el pago por adelantado u otras garantías, incluso una vez perfeccionado el contrato de venta.

No se admitirá demora en el pago debido a reclamaciones exigiendo minoración, cancelación u otras compensaciones, ni descuentos por tales conceptos.

7º – Entrega y envío

Salvo acuerdo en sentido diferente, nuestras condiciones de entrega son siempre ex fábrica, excluido el embalaje, siendo la entrega y el envío de la mercancía por cuenta y riesgo del cliente. Seguros contra hurto, daños en el transporte, etc. se contratarán sólo previo encargo expreso del cliente y por cuenta del mismo. De no recibir instrucciones concretas, nosotros elegiremos el modo de transporte más conveniente.

Mercancía que esté disponible en la fecha de entrega convenida, ha de ser aceptada de inmediato. En caso contrario, la mercancía será almacenada por cuenta y riesgo del cliente y facturada en la fecha de entrega convenida.

Los importes netos mínimos por envío, salvo indicación contraria en nuestra oferta, son:

Mercado interior EUR 100,-

Exportación EUR 500,-

Nos reservamos el derecho de retener pedidos de valor inferior hasta acumular el importe mínimo o expedirlos con un recargo de EUR 10,-.

8º – Reserva de propiedad

La mercancía seguirá siendo de nuestra propiedad hasta su total pago, independientemente de la causa legal del impago.

Mientras no se haya producido una demora del pago o un impago, el cliente tiene el derecho de revender la mercancía por procedimientos comerciales normales. Si la reventa se produce de mercancía sobre la que aún pesa la servidumbre de reserva de propiedad, el cliente cede automáticamente los derechos de cobro a nosotros, sin que para ello se requiera un convenio expreso.

El cliente no está autorizado a ceder tales derechos de cobro a terceros u ofrecerlos como garantía.

Hasta el total y definitivo pago de la mercancía, nosotros tenemos el derecho de exigir la devolución de la misma, acceder a las instalaciones del cliente y llevarnos la mercancía, sin siquiera ejercer el derecho de cancelación del contrato de venta o de concesión de un plazo adicional.

En el caso de que la mercancía suministrada por nosotros haya sido objeto de una transformación o elaboración o incluso de una incorporación inseparable en otro objeto de la propiedad del cliente, entonces nosotros nos convertimos en copropietarios de tal objeto, en la proporción del valor en factura de la mercancía en reserva de propiedad con los demás objetos transformados o incorporados en la fecha de su transformación o incorporación.

Si la mercancía suministrada se transforma o se utiliza por el cliente o por encargo del mismo, como parte de una unidad mayor, nuestra propiedad

pasará a ser parte de la mercancía transformada o de la unidad mayor en la proporción correspondiente. El cliente custodiará la propiedad o copropiedad del suministrador y se compromete a asegurarla contra incendio, hurto y daños por agua. Cualquier tipo de indemnización resultante de un siniestro de este tipo será transferido a nosotros a cuenta de nuestros cobros pendientes.

Embargos o cualquier otro tipo de acciones que afecten a nuestra propiedad, han de sernos notificados de inmediato.

Sin que ello limite las condiciones detalladas arriba, el cliente correrá con el riesgo de la mercancía entregada a partir de la fecha de su expedición.

9º – Plazo de entrega, disponibilidad

Indicaciones de plazo de entrega son aproximadas y no vinculantes para nosotros. No se podrán reclamar gastos por demora o daños y perjuicios por retrasos en la entrega. El plazo de entrega empieza a contar a partir de la fecha en la que hayan quedado definitivamente concertados todos los detalles comerciales y técnicos.

Tenemos el derecho de efectuar entregas parciales.

10º – Fuerza mayor

Huelgas, cierres patronales, catástrofes naturales, interrupciones de la producción, falta de material o de medios de transporte u otros eventos de fuerza mayor, independientemente de si se producen en nuestra empresa o en nuestros suministradores, nos liberan de toda obligación.

11º – Reclamaciones por defectos

Reclamaciones por defectos se aceptarán solamente por escrito y si se presentan de inmediato, es decir, a la recepción de la mercancía. El cliente no tiene derecho a anular el pedido ni de disminuir el importe de la factura.

Reclamaciones que sobrepasen el valor de la mercancía, no serán admitidas. Daños producidos durante el transporte han de reclamarse al transportista.

12º – Garantías

Todos los fabricados de HEYCO se someten a exhaustivos controles de calidad y por consiguiente están plenamente garantizados.

Toda herramienta que tenga un defecto de material y/o de fabricación, será repuesta sin cargo. Queda excluida cualquier garantía que sobrepase este límite. No se procederá a la reposición gratuita si se comprueba que la herramienta ha sido usada indebidamente o si se trata de un desgaste normal.

13º – Daños y perjuicios

Se excluyen expresamente indemnizaciones por daños y perjuicios derivados de la falta de propiedades prometidas, demoras, imposibilidad de cumplimiento, lesión culpable de obligaciones marginales del contrato, culpabilidad al cerrar el contrato o actos ilegales, salvo en el caso de que quede demostrado que se haya actuado con premeditación o con grave negligencia por parte de nuestros representantes legales o demás representantes. También en el caso de graves negligencias, la indemnización se limita al daño previsible en la fecha de producirse el contrato de venta.

14º – Lugar de cumplimiento y competencia judicial

El lugar de cumplimiento para entrega y pago es Remscheid. El juzgado competente es el de Remscheid.

Se aplica la legislación de la República Federal de Alemania.

15º – Exportación y re-exportación

Mercancía procedente de HEYCO no podrá ser exportada o re-exportada sin nuestra previa autorización por escrito.

Abkürzungen und Hinweise

Abbreviations and notes

Abréviations et indications

Abreviaturas e información

ST 00	standardmäßig
G 05	gesandstrahlt
A 10	schwarz
AS 11	schwarz, teilweise geschliffen
ASD 13	schwarz, teilweise geschliffen, Griffe kunststoffbeschichtet
L 20	lackiert
LS 21	lackiert, teilweise geschliffen
LD 24	lackiert, Griffe kunststoffbeschichtet
LG 25	lackiert, teilweise gesandstrahlt
B 30	brüniert
BI 32	brüniert, mit Kunststoffhüllen
BV 33	brüniert, VDE 1000 Volt schutzisoliert
PH 36	phosphatiert
PHS 37	phosphatiert, teilweise geschliffen
P 40	poliert
MS 45	Messing
N 50	vernickelt
ND 54	vernickelt, Griffe kunststoffbeschichtet
NI 55	vernickelt, mit Kunststoffhüllen
Z 60	verzinkt, blau chromatiert
ZCG 61	verzinkt, gelb chromatiert
K 68	antikorrosive Spezialbeschichtung
CL 70	chromfarbig
C 80	verchromt
CP 82	verchromt, teilweise poliert
CPP 83	verchromt, ganz poliert
CI 85	verchromt, kunststoffüberzogen
CPI 86	verchromt, Kopf poliert, mit Kunststoffhüllen
CPD 87	verchromt, Kopf poliert, Griffe kunststoffbeschichtet
CPV 88	verchromt, Kopf poliert, VDE-Isoliergriffhüllen

ST 00	standard
G 05	sandblasted
A 10	black
AS 11	black, partly ground
ASD 13	black, partly ground, plastic coated handles
L 20	lacquered
LS 21	lacquered, partly ground
LD 24	lacquered, plastic coated handles
LG 25	lacquered, partly sandblasted
B 30	gun-metal finish
BI 32	gun-metal finish, insulated
BV 33	gun-metal finish, VDE 1000 volt insulated
PH 36	phosphated
PHS 37	phosphated, partly ground
P 40	polished
MS 45	brass
N 50	nickel plated
ND 54	nickel plated, plastic coated handles
NI 55	nickel plated, insulated
Z 60	zinc plated, blue chromatised
ZCG 61	zinc plated, yellow chromatised
K 68	special anti-corrosive plating
CL 70	chrome coloured
C 80	chrome plated
CP 82	chrome plated, partly polished
CPP 83	chrome plated, fully polished
CI 85	chrome plated, insulated
CPI 86	chrome plated, polished head, insulated
CPD 87	chrome plated, polished head, plastic coated handles
CPV 88	chrome plated, polished head, VDE insulated handles

ST 00	standard
G 05	sablé
A 10	noir
AS 11	noir, partiellement meulé
ASD 13	noir, partiellement poli, branches gainées plastique
L 20	laqué
LS 21	laqué, partiellement meulé
LD 24	laqué, branches gainées plastique
LG 25	laqué, partiellement sablé
B 30	bruni
BI 32	bruni, branches gainées plastique
BV 33	bruni, isolé VDE 1000 volts
PH 36	phosphaté
PHS 37	phosphaté, partiellement meulé
P 40	poli
MS 45	laiton
N 50	nickelé
ND 54	nickelé, branches gainées plastique
NI 55	nickelé, branches gainées plastique
Z 60	galvanisé, bleu passivé
ZCG 61	galvanisé, jaune passivé
K 68	couche spéciale anticorrosive
CL 70	couleur chrome
C 80	chromé
CP 82	chromé, partiellement poli
CPP 83	chromé, entièrement poli
CI 85	chromé, gainé plastique
CPI 86	chromé, tête polie, branches gainées plastique
CPD 87	chromé, tête polie, branches gainées plastique
CPV 88	chromé, tête polie, branches isolées VDE 1000 volts

ST 00	estándar
G 05	granallado
A 10	negro
AS 11	negro, parcialmente pulido
ASD 13	negro, parcialmente pulido, mangos plastificados
L 20	barnizado
LS 21	barnizado, parcialmente pulido
LD 24	barnizado, mangos plastificados
LG 25	barnizado, parcialmente granallado
B 30	pavonado
BI 32	pavonado, con fundas de plástico
BV 33	pavonado, aislado VDE 1000 V
PH 36	fosfatado
PHS 37	fosfatado, parcialmente amolado
P 40	pulido
MS 45	latonado
N 50	niquelado
ND 54	niquelado, mangos plastificados
NI 55	niquelado, con fundas de plástico
Z 60	cincado, cromatizado azul
ZCG 61	cincado, cromatizado amarillo
K 68	recubrimiento especial anticorrosivo
CL 70	cromatizado
C 80	cromado
CP 82	cromado, parcialmente pulido espejo
CPP 83	cromado, enteramente pulido espejo
CI 85	cromado, plastificado
CPI 86	cromado, cabeza pulida, con fundas de plástico
CPD 87	cromado, cabeza pulida, mangos plastificados
CPV 88	cromado, cabeza pulida, aislado VDE 1000 V

00000000000*

Artikel läuft aus,
Lagervorrat vorhanden

POZIDRIV®
eingetragenes Warenzeichen der Firma
European Industrial Services Ltd.

TORX®
eingetragenes Warenzeichen der Firma
CAMCAR/TEXTRON INC.

Alle Katalogartikel werden technisch
ständig optimiert; daher sind Änderun-
gen jederzeit und ohne Ankündigung
möglich.

Der Nachdruck dieses Kataloges oder
von Teilen daraus, die Vervielfältigung,
Speicherung und Übermittlung jed-
weder Art, auch durch Datenverar-
beitungsanlagen, sind nur mit unserer
schriftlichen Genehmigung gestattet.

00000000000*

Production discontinued,
small stocklots

POZIDRIV®
Registered trade mark
of European Industrial Services Ltd.

TORX®
Registered trade mark
of CAMCAR/TEXTRON INC.

All catalogue articles are continuously
updated to the latest technical standards.
As a result, specifications are subject to
change without prior notice.

Reprint of this catalogue or parts thereof,
reproduction, storage in retrieval systems,
unauthorized utilization and transmission
in any form or by any means including
computer systems is only permitted with
our prior consent in writing.

00000000000*

Fabrication suspendue petites
quantités encore en stock

POZIDRIV®
marque déposée par la société
European Industrial Services Ltd.

TORX®
marque déposée par la société
CAMCAR/TEXTRON INC.

Les produits du catalogue étant soumis
à des améliorations techniques
permanentes, le fabricant se réserve le
droit de modifier leurs caractéristiques
à tout moment et sans préavis.
Toute reproduction, copie ou diffusion,
totale ou partielle de ce catalogue, par
quelque procédé que ce soit,
notamment par photocopie ou par
équipement informatique, est interdite
sans notre autorisation écrite.

00000000000*

Artículo fuera de programa,
disponible salvo venta

POZIDRIV®
marca registrada de
European Industrial Services Ltd.

TORX®
marca registrada de
CAMCAR/TEXTRON INC.

Todos los artículos del catálogo están
sometidos a perfeccionamiento
continuo. Por eso, están sujetos a
posibles modificaciones sin previo aviso.

La reproducción de este catálogo
íntegra o parcial, cualquier tipo de
memorización y transmisión, incluso
mediante sistemas informáticos
requerirán sin falta nuestra autorización
por escrito.



























Symbole

	Gewicht in Gramm
	Packeinheit
	Länge
	Durchmesser
	auf Seite
	metrische Schlüsselweiten für Schrauben und Muttern mit Außensechskant
	amerikanische Zoll-Schlüsselweiten für Schrauben und Muttern mit Außensechskant
	britische Zoll-Schlüsselweiten für Schrauben und Muttern mit Außensechskant, Maßangaben nach Bolzenstärken
	metrische Schlüsselweiten für Innensechskantschrauben
	amerikanische Zoll-Schlüsselweiten für Innensechskantschrauben
	Schlüsselweite bei TORX®-Schrauben
	Innensechskant
	Innensechskant Schon-Profil
	Innen-Doppelsechskant
	Innen-Doppelsechskant Schon-Profil
	Innenvierkant
	Außenvierkant
	Außensechskant für Innensechskantschrauben
	für Schlitzschrauben
	für Kreuzschlitzschrauben PHILLIPS-RECESS
	für Kreuzschlitzschrauben POZIDRIV®
	KREUZmix für Kreuzschlitzschrauben PHILLIPS-RECESS + POZIDRIV®
	für Innenvielzahn-Schrauben XZN
	für Innenkeilprofil-Schrauben RIBE CV
	für Innen-TORX®-Schrauben
	für Außen-TORX®-Schrauben

Symbols

	weight in grammes
	packing unit
	length
	diameter
	on page
	spanner openings in metric for hexagon head screws, bolts and nuts
	spanner openings in inches (american sizes) for hexagon head screws, bolts and nuts
	spanner openings in inches (british sizes) for hexagon head screws, bolts and nuts sizes stated for diameter of bolt
	sizes in metric for hexagon socket screws and bolts
	sizes in inches (American sizes) for hexagon socket screws and bolts
	size in millimetres for TORX®-screws
	inside hexagon
	inside hexagon Schon-Profil (profile saver)
	inside bihexagon
	inside bihexagon – Schon-Profil (profile saver)
	inside square
	outside square
	outside hexagon
	for plain slot screws
	for cross slot screws PHILLIPS-RECESS
	for cross slot screws POZIDRIV®
	CROSS-MIX for cross slot screws PHILLIPS-RECESS + POZIDRIV®
	for multi-spline socket screws XZN
	for fluted socket screws RIBE CV
	for TORX®-socket screws
	for TORX®-head screws

Symboles

	poids en grammes
	unité d'emballage
	longueur
	diamètre
	page
	ouvertures métriques pour vis et écrous hexagonaux
	ouvertures en pouces (dimensions américaines) pour vis et écrous hexagonaux
	ouvertures en pouces (dimensions britanniques) pour vis et écrous hexagonaux, dimensions indiquées pour le diamètre du boulon
	ouvertures métriques pour vis à 6 pans creux
	ouvertures en pouces (dimensions américaines) pour vis à 6 pans creux
	ouvertures métriques pour vis TORX®
	6 pans intérieur
	6 pans intérieur – profil d'usure
	12 pans intérieur
	12 pans intérieur – profil d'usure
	carré femelle
	carré mâle
	6 pans mâle
	pour vis à fente
	pour vis cruciformes PHILLIPS-RECESS
	pour vis cruciformes POZIDRIV®
	Cruciforme Mixte pour vis cruciformes PHILLIPS-RECESS + POZIDRIV®
	pour vis denture multiple XZN
	pour vis à empreinte à créneaux RIBE CV
	pour vis TORX® intérieures
	pour vis TORX® extérieures

Símbolos

	peso en gramos
	unidad de envase
	longitud
	diámetro
	en página
	medidas métricas para tornillos y tuercas con hexágono exterior
	medidas en pulgadas AF para tornillos y tuercas con hexágono exterior
	medidas en pulgadas Whitworth para tornillos y tuercas con hexágono exterior, medidas referentes al grosor del bulón
	medidas métricas para tornillos con hexágono interior
	medidas en pulgadas AF para tornillos con hexágono interior
	medidas para tornillos TORX®
	hexágono interior
	hexágono interior perfil conservador
	estrella interior
	estrella interior perfil conservador
	cuadradillo interior
	cuadradillo exterior
	hexágono exterior
	para tornillos ranurados
	para tornillos PHILLIPS-RECESS
	para tornillos POZIDRIV®
	CRUZmix para tornillos con ranurado en cruz PHILLIPS-RECESS + POZIDRIV®
	para tornillos XZN
	para tornillos RIBE CV
	para tornillos TORX® interiores
	para tornillos TORX® exteriores

HEYCO
QUALITÄTSWERKZEUGE
GmbH & Co. KG
Birgden III/1
42855 Remscheid
Germany

Tel. +49 (0) 2191 205-0
Fax +49 (0) 2191 205-266
info@heyco.de
heyco-qualitaetswerkzeuge.de



Folgen Sie uns
@heyco_qualitaetswerkzeuge